

# SG 3840

---

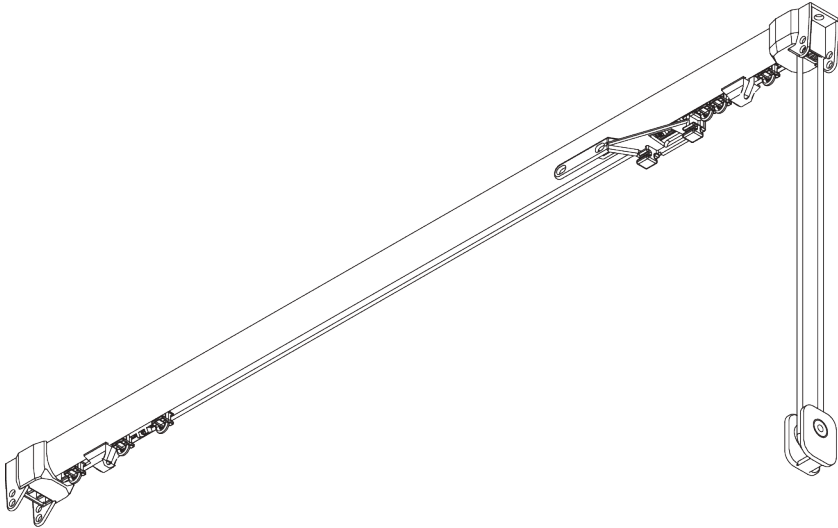
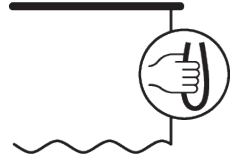

## PRODUCT INFORMATION

- **Operation:** cord
- **Range:** M - L
- **Fitting:** ceiling, wall
- **Colours:** white RAL 9016, black RAL 9005 or anodised aluminum, special colours possible
- **Fabrics:** refer to Silent Gliss fabric collection

### **Features:**

- 2-component (2C) glider technology
- Wave (2C)
- Bendable

# SYSTEM SPECIFICATIONS

## A. SYSTEM DIMENSIONS

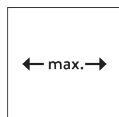

6 m

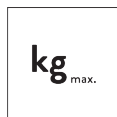

14 kg

### Max. curtain weight - 2C glider or roller

	2 m	4 m	6 m
	12	11	10
	14	13	12
	9	8	7
	10	9	6
	6	5	4
	7	6	5
	5	4	3
	6	5	4

(kg max.)

### Max. curtain weight - Wave 2C glider cord

	2 m	4 m	6 m
	5	8	7
	5	8	8
	5	6	5
	5	6	6
	4	3	-
	4	4	3
	3	2	-
	3	3	-

(kg max.)

## B. PROFILE

### Profile and bending information

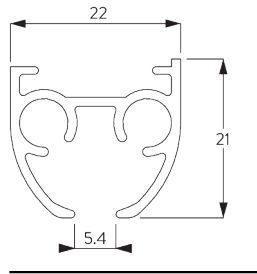

#### SG 3841

Profile

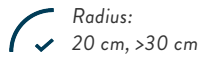

## C. HOW TO MEASURE

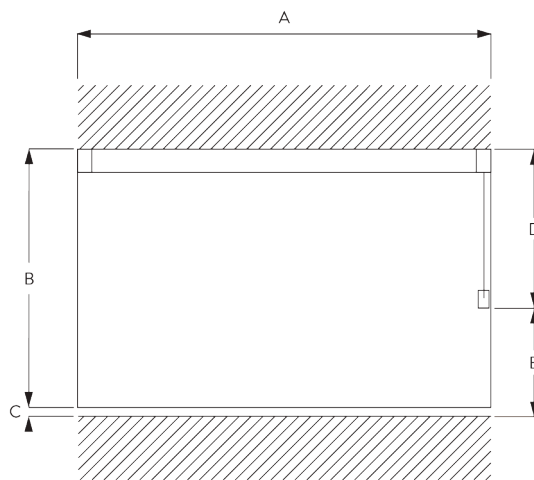

- A: System width
- B: System height
- C: Distance between floor and fabric
- D: Cord height
- E: Safety Retainer SG 10731 min. 150 cm above floor

## D. SPECIFICATION

### TEXT

#### EN

Silent Gliss SG 3840 Cord Operated Curtain Track System. Comprising aluminium profile SG 3841 supplied made to measure in silver anodised or powder coated in white. Supplied with 2C gliders SG 11300 at 14/m. Top fixed with fixing clamp SG 3825/3826/3832 at max. 500 mm centres. Wall fix with SG Smart Fix. Silent Gliss Wave option is available. Compliant to Child Safety legislation EN 13120.

#### SV

Silent Gliss SG 3840 lindragssystem. Består av aluminiumprofil SG 3841 i specificerad längd i vitlack, alu natur eller angiven RAL färg. 14 st 11300 SILENT TRACK glid per meter. Takmonteras med fäste SG 3825 c/c 500 mm. Vägmontering med SG Smart Fix c/c 500 mm. Uppfyller barnsäkerhetsnorm EN 13120. Kan användas med system Wave.

#### NO

Silent Gliss SG 3840 Snortrekksystem. Består av aluminiumprofil SG 3841 i spesifisert lengde. Hvitlakkert, alu natur eller spesifisert RAL farge. 14 stk SG 11300 SILENT TRACK glidere pr meter. Takmonteres med feste SG 3825 c/c 500 mm. Veggmontering med SG Smart Fix c/c 500 mm. Oppfyller kravene i barnesikkerhetsnormen EN13120. kan brukes med Wave system.

#### DA

Silent Gliss SG 3840 gardinskinnesystem med snortræk. Består af en aluminiumprofil SG 3841 i ønsket længde, sølvanodiseret eller hvid pulverlakering. Leveres med 14 stk. 2C glidere SG 11300 pr m. Loftmonteres med spændebøjle SG 3825/3826/3832 med højst 500 mm afstand. Vægmonteres med SG Smart Fix. Kan bruges med Silent Gliss Wave. Overholder lovgivning om børnesikkerhed efter EN 13120.

# FITTING

## A. FITTING INFORMATION

For detailed fitting information, visit the Silent Gliss website.

### Fixing Points

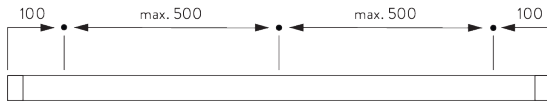

## B. CEILING FITTING

### Clamp SG 3825

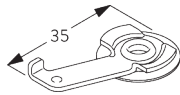
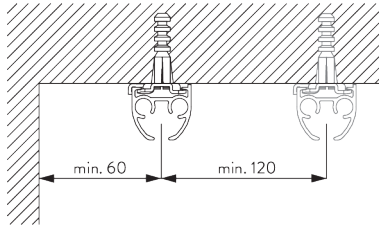

**SG 3825**

Clamp

### Bracket SG 3832

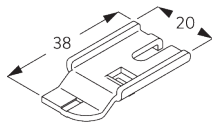
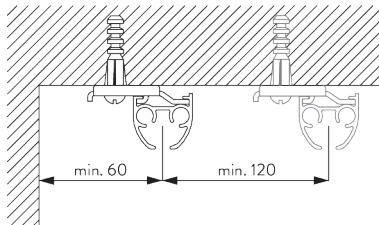

**SG 3832**

Bracket

### Bracket SG 3826

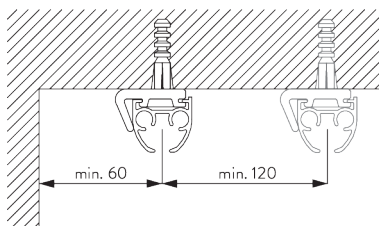

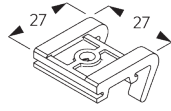

**SG 3826**  
Bracket

**C. WALL FITTING**

**Smart Fix**

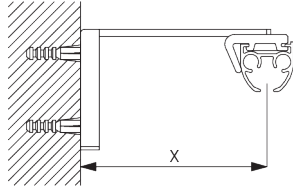

**Smart Fix SG 11200 - SG 11205 and bracket SG 3826:**  
Screw SG 10492 (M4x8) needed.

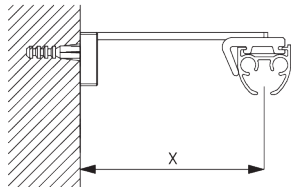

**Square Smart Fix SG 11210 - SG 11215 and bracket SG 3826:**  
Screw SG 10492 (M4x8) needed.

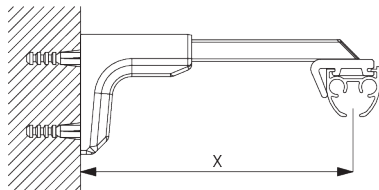

**Universal Smart Fix SG 11154 - SG 11156 and bracket SG 3826:**  
Screw SG 10277 (M4x12) needed.

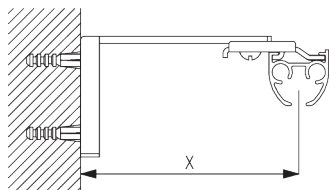

**Smart Fix SG 11200 - SG 11205 and bracket SG 3832:**  
Screw SG 10492 (M4x8) needed.

Smart Fix	X mm (SG 3826 / SG 3825)	X mm (SG 3832)
SG 11200 / SG 11210	52	70
SG 11201 / SG 11211	72	90
SG 11202 / SG 11212	92	110
SG 11203 / SG 11213	112	130
SG 11204 / SG 11214	142	160
SG 11205 / SG 11215	192	210
SG 11154	102-130	120-148
SG 11155	132-160	150-178
SG 11156	182-210	200-228

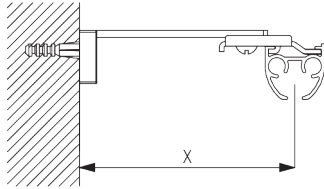

**Square Smart Fix SG 11210 - SG 11215 and bracket SG 3832:**

Screw SG 10492 (M4x8) needed.

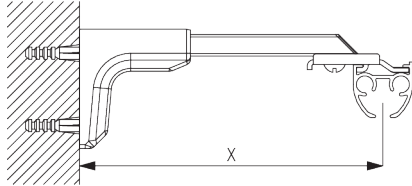

**Universal Smart Fix SG 11154 - SG 11156 and bracket SG 3832:**

Screw SG 10407 (M4x10) needed.

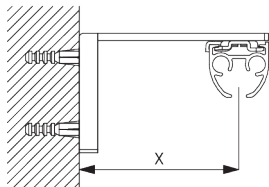

**Smart Fix SG 11200 - SG 11205 and clamp SG 3825:**

Screw SG 10074 (M4x8) needed.

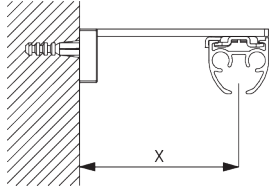

**Square Smart Fix SG 11210 - SG 11215 and clamp SG 3825:**

Screw SG 10074 (M4x8) needed.

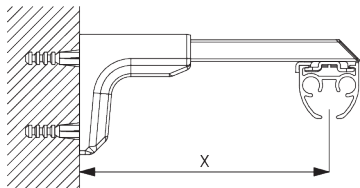

**Universal Smart Fix SG 11154 - SG 11156 and clamp SG 3825:**

Screw SG 11158 (M4x12) needed.

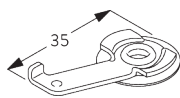

**SG 3825**  
Clamp

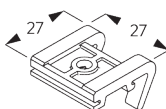

**SG 3826**  
Bracket

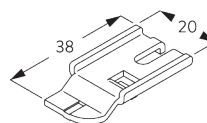

**SG 3832**  
Bracket



**SG 10074**  
Countersunk head screw  
M4x8



**SG 10277**  
Pan head screw M4x12



**SG 10407**  
Pan head screw M4x10



**SG 10492**  
Pan head screw M4x8



**SG 11158**  
Countersunk head screw M4x12

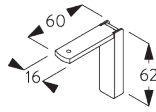

**SG 11200**  
Smart Fix 60 mm

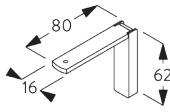

**SG 11201**  
Smart Fix 80 mm

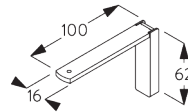

**SG 11202**  
Smart Fix 100 mm

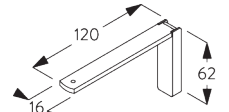

**SG 11203**  
Smart Fix 120 mm

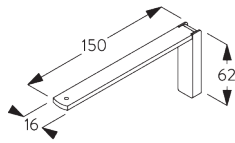

**SG 11204**  
Smart Fix 150 mm

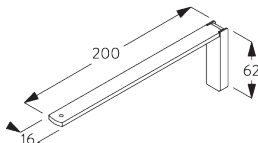

**SG 11205**  
Smart Fix 200 mm

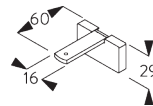

**SG 11210**  
Square Smart Fix 60 mm

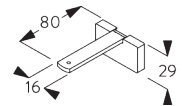

**SG 11211**  
Square Smart Fix 80 mm

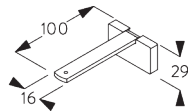

**SG 11212**  
Square Smart Fix 100 mm

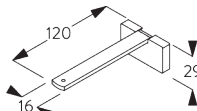

**SG 11213**  
Square Smart Fix 120 mm

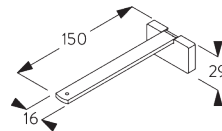

**SG 11214**  
Square Smart Fix 150 mm

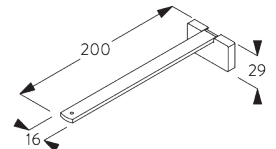

**SG 11215**  
Square Smart Fix 200 mm

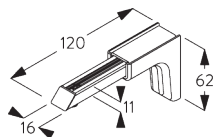

**SG 11154**  
Universal Smart Fix 120 mm

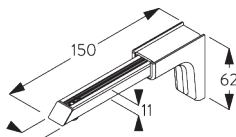

**SG 11155**  
Universal Smart Fix 150 mm

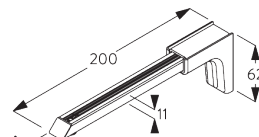

**SG 11156**  
Universal Smart Fix 200 mm

**Bracket SG 3836**

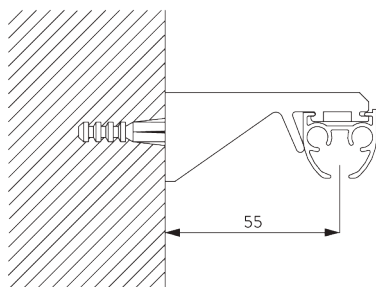

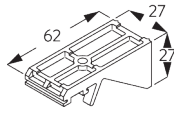

**SG 3836**  
Bracket

# SYSTEM OPTIONS

## A. WAVE

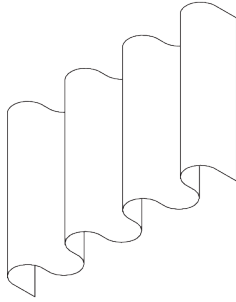

SG 11295

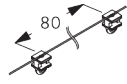

SG 11302

*Standard components:*

- SG 11295 End stop
- SG 11302 Wave 2C glider cord 80 mm

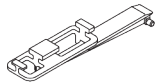

SG 6364



SG 6365

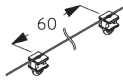

SG 11303

*Optional components (min. radius >30 cm):*

- SG 6364 Wave extension
- SG 6365 Wave hanger
- SG 11303 Wave 2C glider Cord 60 mm



SG 3582

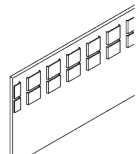

SG 6349

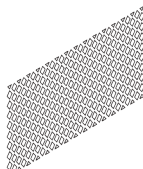

SG 6363

*Curtain components:*

- SG 3582 Hook
- SG 6349 Wave curtain tape
- SG 6363 Wave top hemming tape
- SG 10075 Lead weight 50 gr/m
- SG 10076 Fabric weight

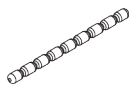

SG 10075



SG 10076



Wave stack depth - 2C glider cord (standard components)

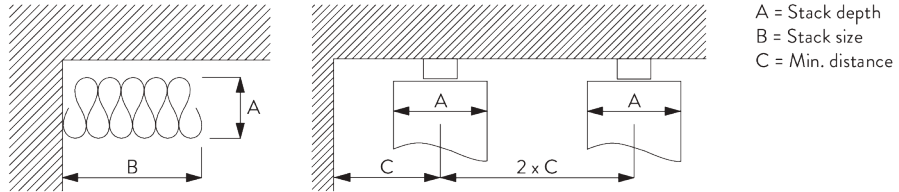

2C Glider cord SG 11302	Pockets between hooks	Approx. curtain fullness	Stack depth A	Stack size B*	Min distance C
80	6	~2.1	140	180 per metre of track	90
80	7	~2.3	160	180 per metre of track	100

2C Glider cord SG 11303	Pockets between hooks	Approx. curtain fullness	Stack depth A	Stack size B*	Min distance C
60	4	~2.1	100	230 per metre of track	70
60	5	~2.3	120	230 per metre of track	80

*\*Stack size B standard*





- single stack = plus 130 mm per curtain
- pair stack = plus 30 mm per curtain

*\*Stack size B optional*





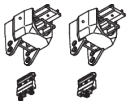
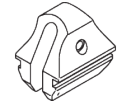
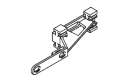
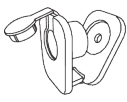





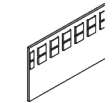

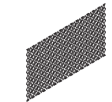

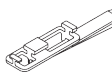

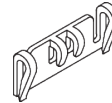

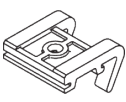

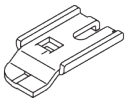
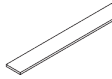
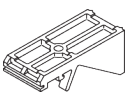
- single stack = plus 200 mm per curtain
- pair stack = plus 200 mm per curtain

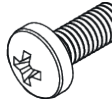
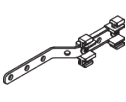
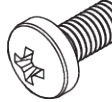
# PARTS

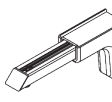
## A. STANDARD PARTS

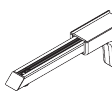
	<b>SG 3090</b> Cord ø 3.5 mm
	<b>SG 3825</b> Clamp
	<b>SG 3841</b> Profile
	<b>SG 3845</b> Cord guide set
	<b>SG 6086</b> Spring stop
	<b>SG 6288</b> Overlap arm
	<b>SG 10731</b> Child safety retainer set
	<b>SG 11300</b> 2C glider

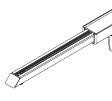
## B. OPTIONAL PARTS

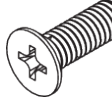
	<b>SG 3340</b> Cord/chain weight		<b>SG 6349</b> Wave curtain tape
	<b>SG 3581</b> Hook		<b>SG 6363</b> Wave top hemming tape
	<b>SG 3582</b> Hook		<b>SG 6364</b> Wave extension
	<b>SG 3735</b> Cord weight with tensioner		<b>SG 6365</b> Wave hanger
	<b>SG 3802</b> Connection bridge		<b>SG 10074</b> Countersunk head screw M4x8
	<b>SG 3826</b> Bracket		<b>SG 10075</b> Lead weight 50 g/m
	<b>SG 3832</b> Bracket		<b>SG 10076</b> Fabric weight
	<b>SG 3836</b> Bracket		<b>SG 10277</b> Pan head screw M4x12
	<b>SG 6053</b> Spring stop		<b>SG 10407</b> Pan head screw M4x10
	<b>SG 6063</b> Overlap arm		<b>SG 10492</b> Pan head screw M4x8
	<b>SG 6065</b> End stop		<b>SG 11154</b> Universal Smart Fix 120 mm
	<b>SG 6094</b> Roller		<b>SG 11155</b> Universal Smart Fix 150 mm
	<b>SG 6098</b> Roller		<b>SG 11156</b> Universal Smart Fix 200 mm
	<b>SG 6283</b> Roller		<b>SG 11158</b> Countersunk head screw M4x12



**SG 11200**  
Smart Fix 60 mm

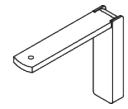

**SG 11201**  
Smart Fix 80 mm

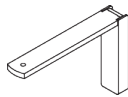

**SG 11202**  
Smart Fix 100 mm

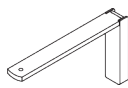

**SG 11203**  
Smart Fix 120 mm



**SG 11204**  
Smart Fix 150 mm

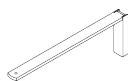

**SG 11205**  
Smart Fix 200 mm

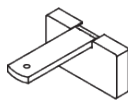

**SG 11210**  
Square Smart Fix 60 mm

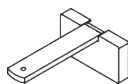

**SG 11211**  
Square Smart Fix 80 mm

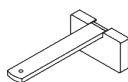

**SG 11212**  
Square Smart Fix 100 mm

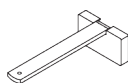

**SG 11213**  
Square Smart Fix 120 mm

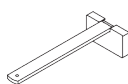

**SG 11214**  
Square Smart Fix 150 mm

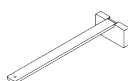

**SG 11215**  
Square Smart Fix 200 mm

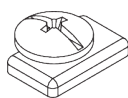

**SG 11295**  
End stop



**SG 11301**  
2C glider on strip

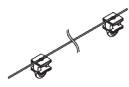

**SG 11302**  
Wave 2C glider cord 80 mm

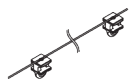

**SG 11303**  
Wave 2C glider cord 60 mm

