

CORD OPERATED CURTAIN TRACK SYSTEMS

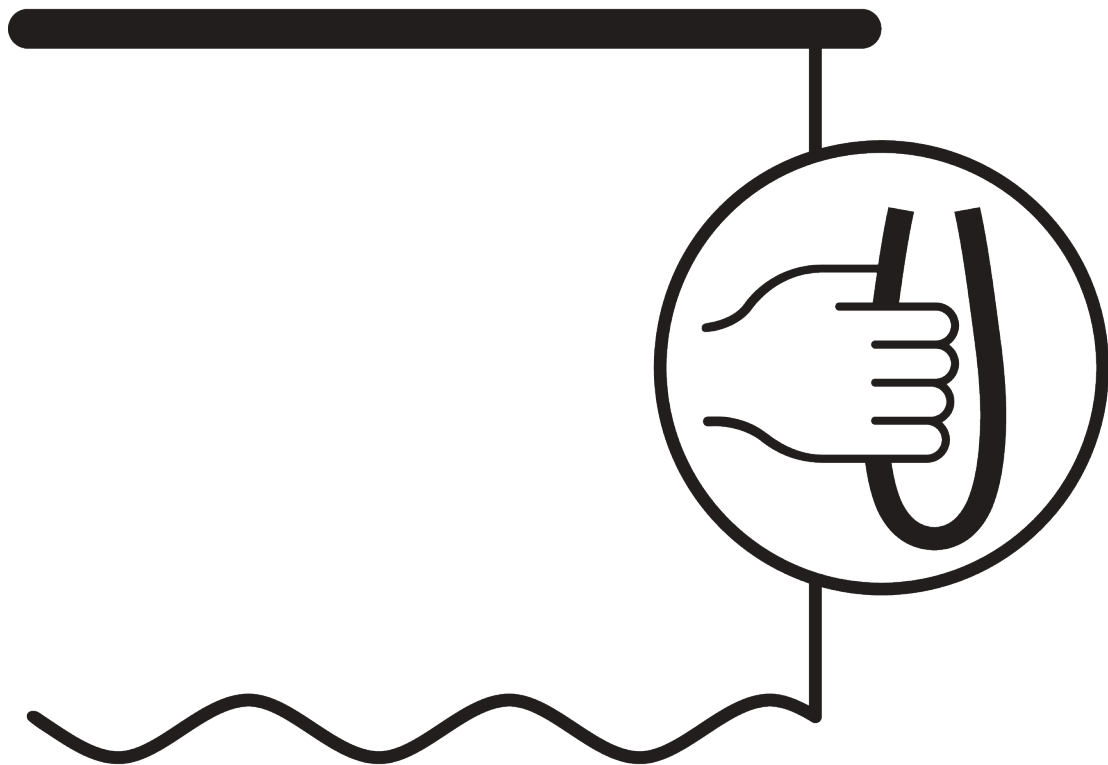

GENERAL NOTES

Dimensions

- Measurements are in mm except where indicated.
- Max. kg relates to fabric incl. accessories.
- Stack size depends on curtain make-up and fabric thickness.
- Distance between gliders max. 80 mm / distance between rollers max. 100 mm.
- Recommended distance floor / fabric: 20 mm.
- In order to determine system height (B), the smallest room height must be taken into account.
- Full functionality may be affected if the curtain touches the profile.











Fitting

- Installation by qualified fitter only.
- Number of brackets and fitting positions / fixing points vary depending on fitting surface, system weight, fabric make-up, screw / fixing type and obstacles.
- Qualified fitter must use appropriate screws / fixings for each situation.
- Profile lip if applicable to be installed to room side.

Child Safety

- All relevant Silent Gliss systems correspond to child safety EN 13120.
- All parties involved must comply with EN 13120.

APPLICATION CHART

<u>PAGE</u>	<u>SYSTEM</u>	<u>OPERATION</u>	<u>DIMENSION</u>	<u>DESIGN</u>	<u>WAVE</u>	← max. →	kg _{max.}
5	SG 3000		S - M			6 m	15 kg
13	SG 3840		M - L			6 m	14 kg
25	SG 3870		M - L			6 m	14 kg
37	SG 3970		M - L			15 m	38 kg

SG 3000

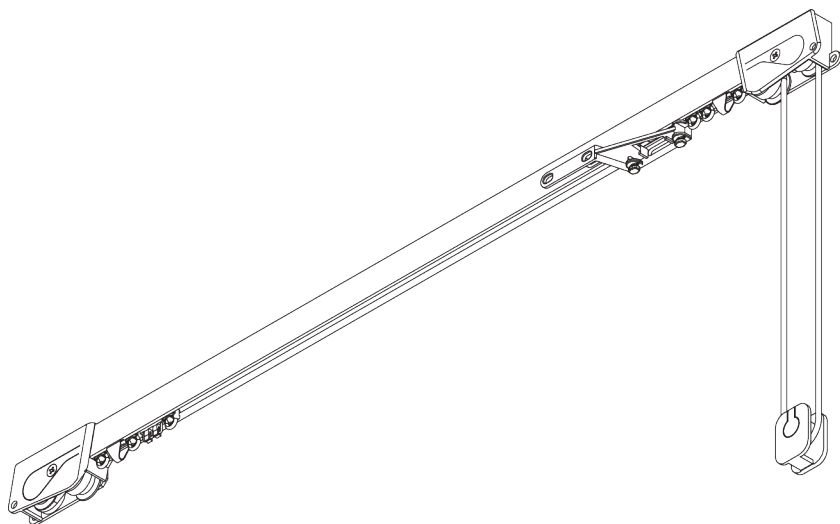
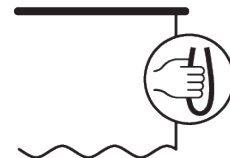

PRODUCT INFORMATION

- **Operation:** cord
- **Range:** S - M
- **Fitting:** ceiling, wall, suspended
- **Colours:** white RAL 9016 or anodised aluminum, special colours possible
- **Fabrics:** refer to Silent Gliss fabric collection

Features:

- Bendable

SYSTEM SPECIFICATIONS

A. SYSTEM DIMENSIONS

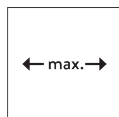

6 m

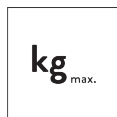

15 kg

Max. curtain weight

	2 m	4 m	6 m
	15	14	13
	15	14	13
	10	7	5
	10	7	5
	5	4	3
	5	4	3
	4	3	-
	4	3	-

(kg max.)

B. PROFILE

Profile and bending information

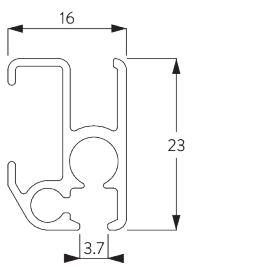

SG 1082

Profile

Radius:
✓ 10 cm, 20 cm, >30 cm

C. HOW TO MEASURE

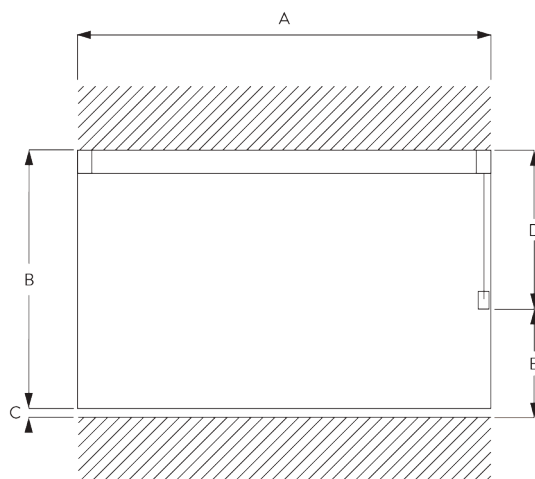

- A: System width
- B: System height
- C: Distance between floor and fabric
- D: Cord height
- E: Safety Retainer SG 10731 min. 150 cm above floor

D. SPECIFICATION TEXT

EN

Silent Gliss SG 3000 Cord Operated Curtain Track System. Comprises aluminium profile SG 1082 supplied made to measure in powder coated white with gliders SG 3533 at 14/m. Top fixed with nylon bracket SG 3603 at 600 to 800 mm centres. Wall fixed with SG Smart Fix / Compliant to Child Safety legislation EN 13120.

SV

Silent Gliss SG 3000 lindragssystem. Består av aluminiumprofil SG 1082 i specificerad längd i vitlack. 14 st SG 3533 glid per meter. Takmonteras med fäste SG 3603 c/c 600-800 mm. Vägghontering med SG Smart Fix c/c 600-800 mm. Uppfyller barnsäkerhetsnorm EN 13120.

NO

Silent Gliss SG 3000 Snortrekksystem. Består av aluminiumprofil SG 1082 i spesifisert hvitlakkert lengde. 14 stk SG 3533 glidere pr meter. Takmonteres med feste SG 3603 c/c 600-800 mm. Veggmontering med SG Smart Fix c/c 600-800 mm. Oppfyller kravene i barnesikkerhetsnormen EN13120.

DA

Silent Gliss SG 3000 gardinskinnesystem med snortræk. Består af aluminiumprofil SG 1082 i ønsket længde, i hvid pulverlakering med 14 stk. glidere SG 3533 pr. m. Loftmonteres med nylonbeslag SG 3603 med højst 600 til 800 mm afstand. Vægmonteres med SG Smart Fix. Overholder lovgivning om børnesikkerhed efter EN 13120.

FITTING

A. FITTING INFORMATION

Fixing points

For detailed fitting information, visit the Silent Gliss website.

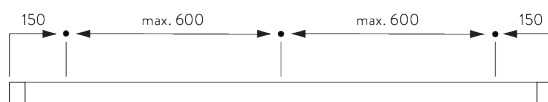

B. CEILING FITTING

Bracket SG 3603

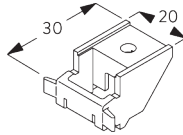
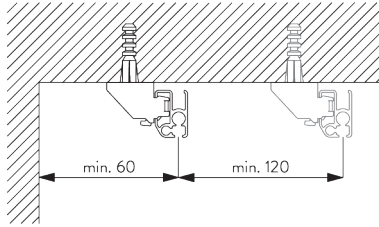

SG 3603

Bracket

C. WALL FITTING

Smart Fix

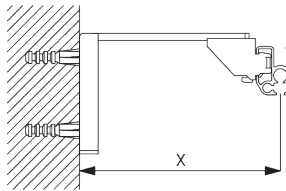

Smart Fix SG 11200 - SG 11205 and bracket SG 3603:

Screw SG 10492 (M4x8) needed.

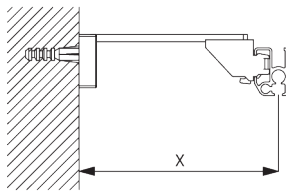

Square Smart Fix SG 11210 - SG 11215 and bracket SG 3603:

Screw SG 10492 (M4x8) needed.

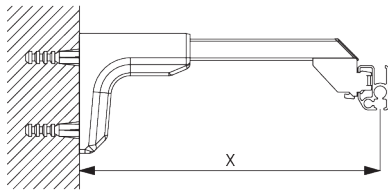

Universal Smart Fix SG 11154 - SG 11156 and bracket SG 3603:

Screw SG 10277 (M4x12) needed.

Smart Fix	X mm
SG 11200 / SG 11210	76
SG 11201 / SG 11211	96
SG 11202 / SG 11212	116
SG 11203 / SG 11213	136
SG 11204 / SG 11214	166
SG 11205 / SG 11215	216
SG 11154	127-155
SG 11155	157-185
SG 11156	207-235

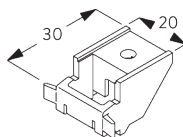

SG 3603

Bracket



SG 10277

Pan head screw M4x12



SG 10492

Pan head screw M4x8

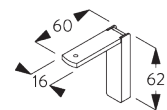

SG 11200

Smart Fix 60 mm

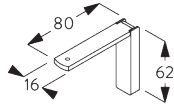

SG 11201
Smart Fix 80 mm

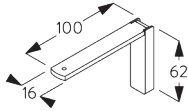

SG 11202
Smart Fix 100 mm

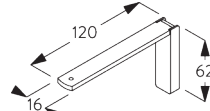

SG 11203
Smart Fix 120 mm

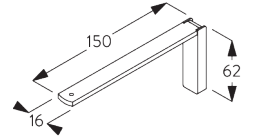

SG 11204
Smart Fix 150 mm

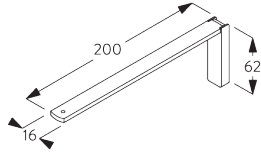

SG 11205
Smart Fix 200 mm

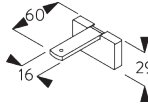

SG 11210
Square Smart Fix 60 mm

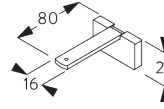

SG 11211
Square Smart Fix 80 mm

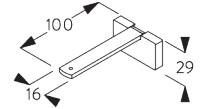

SG 11212
Square Smart Fix 100 mm

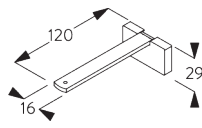

SG 11213
Square Smart Fix 120 mm

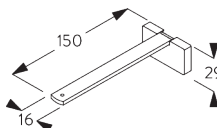

SG 11214
Square Smart Fix 150 mm

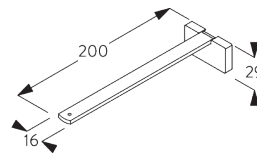

SG 11215
Square Smart Fix 200 mm

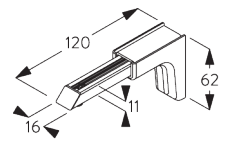

SG 11154
Universal Smart Fix 120 mm

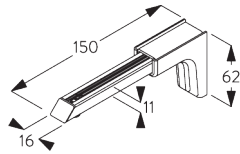

SG 11155
Universal Smart Fix 150 mm

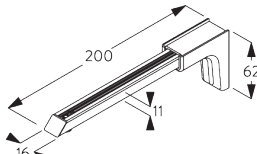

SG 11156
Universal Smart Fix 200 mm

**Universal brackets
SG 3630, SG 3655,
SG 3660**

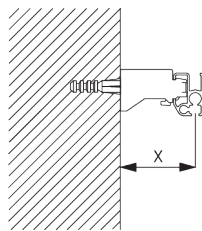

Bracket	X mm
SG 3630	39
SG 3655	54
SG 3660	69

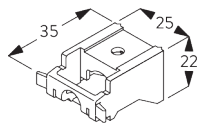

SG 3630
Bracket 35 mm

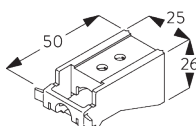



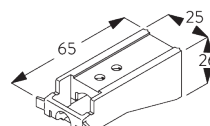



SG 3655
Bracket 50 mm





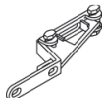
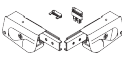

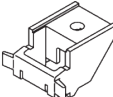











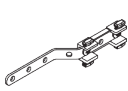
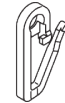

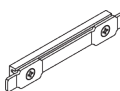
SG 3660
Bracket 65 mm

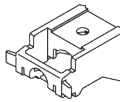
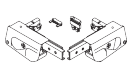
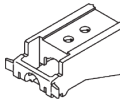
PARTS

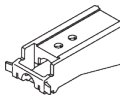
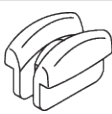
A. STANDARD PARTS

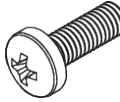
	SG 1082 Profile
	SG 3085 Spring stop
	SG 3090 Cord ø 3.5 mm
	SG 3242 Overlap arm
	SG 3288 Cord guide set
	SG 3533 Glider
	SG 3599 Hook
	SG 3603 Bracket
	SG 10731 Child safety retainer set

B. OPTIONAL PARTS

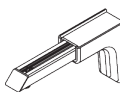
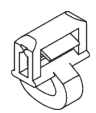
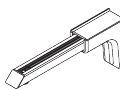
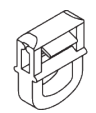
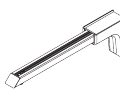
	SG 3012 Hook		SG 3549 Click glider with hook
	SG 3030 Pilot runner		SG 3555 Hook
	SG 3032 Spring stop		SG 3582 Hook
	SG 3045 Overlap arm		SG 3598 Eyelet
	SG 3070 End stop		SG 3620 Connection bridge
	SG 3091 Cord ø 3.5 mm		SG 3630 Bracket 35 mm
	SG 3289 Cord guide set		SG 3655 Bracket 50 mm
	SG 3340 Cord/chain weight		SG 3660 Bracket 65 mm
	SG 3511 Glider		SG 3735 Cord weight with tensioner
	SG 3534 Glider 3533 on strip		SG 10277 Pan head screw M4x12
	SG 3535 Glider		SG 10492 Pan head screw M4x8
	SG 3537 Glider		SG 11154 Universal Smart Fix 120 mm
	SG 3547 Glider		SG 11155 Universal Smart Fix 150 mm
	SG 3548 Glider		SG 11156 Universal Smart Fix 200 mm

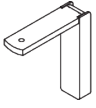
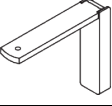
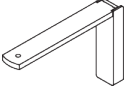
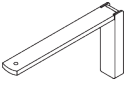
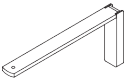
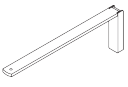
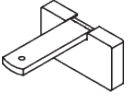
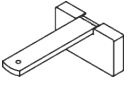
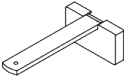
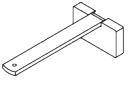
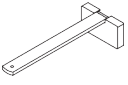
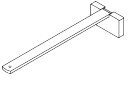
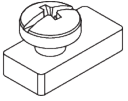
	SG 11200 Smart Fix 60 mm
	SG 11201 Smart Fix 80 mm
	SG 11202 Smart Fix 100 mm
	SG 11203 Smart Fix 120 mm
	SG 11204 Smart Fix 150 mm
	SG 11205 Smart Fix 200 mm
	SG 11210 Square Smart Fix 60 mm
	SG 11211 Square Smart Fix 80 mm
	SG 11212 Square Smart Fix 100 mm
	SG 11213 Square Smart Fix 120 mm
	SG 11214 Square Smart Fix 150 mm
	SG 11215 Square Smart Fix 200 mm
	SG 11335 End stop

SG 3840

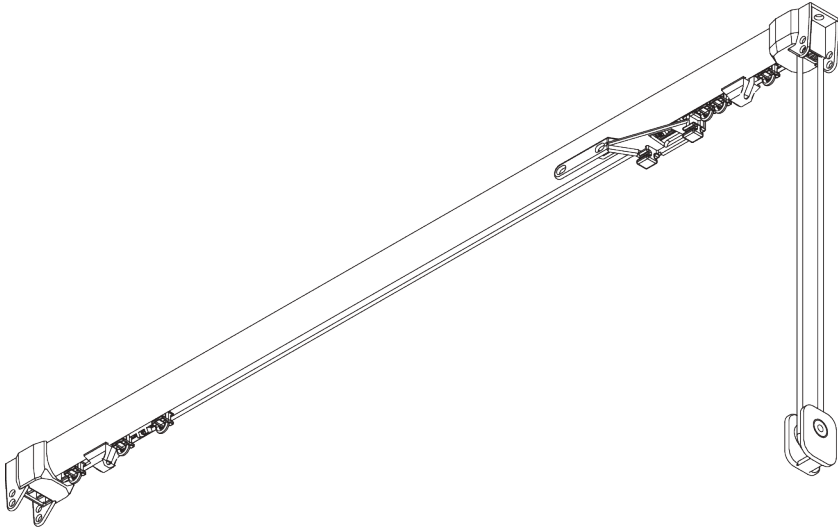
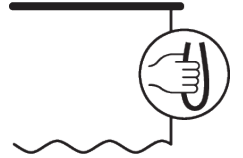

PRODUCT INFORMATION

- **Operation:** cord
- **Range:** M - L
- **Fitting:** ceiling, wall
- **Colours:** white RAL 9016, black RAL 9005 or anodised aluminum, special colours possible
- **Fabrics:** refer to Silent Gliss fabric collection

Features:

- 2-component (2C) glider technology
- Wave (2C)
- Bendable

SYSTEM SPECIFICATIONS

A. SYSTEM DIMENSIONS

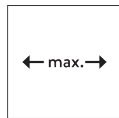

6 m



14 kg

Max. curtain weight - 2C glider or roller

	2 m	4 m	6 m
	12	11	10
	14	13	12
	9	8	7
	10	9	6
	6	5	4
	7	6	5
	5	4	3
	6	5	4

(kg max.)

Max. curtain weight - Wave 2C glider cord

	2 m	4 m	6 m
	5	8	7
	5	8	8
	5	6	5
	5	6	6
	4	3	-
	4	4	3
	3	2	-
	3	3	-

(kg max.)

B. PROFILE

Profile and bending information

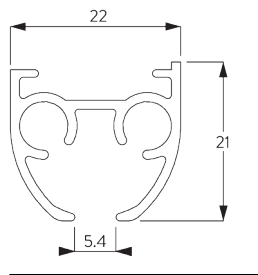

SG 3841

Profile

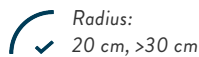

C. HOW TO MEASURE

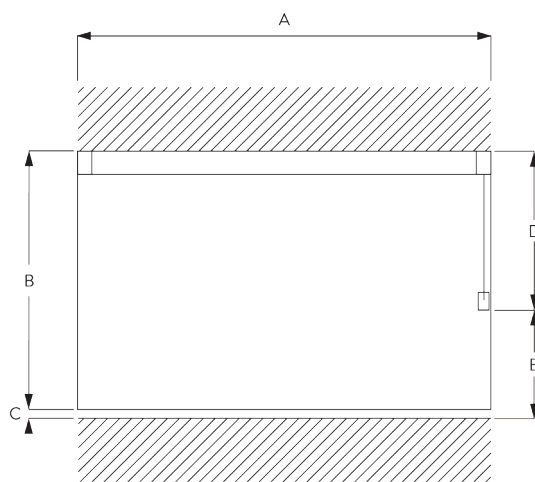

- A: System width
- B: System height
- C: Distance between floor and fabric
- D: Cord height
- E: Safety Retainer SG 10731 min. 150 cm above floor

D. SPECIFICATION

TEXT

EN

Silent Gliss SG 3840 Cord Operated Curtain Track System. Comprising aluminium profile SG 3841 supplied made to measure in silver anodised or powder coated in white. Supplied with 2C gliders SG 11300 at 14/m. Top fixed with fixing clamp SG 3825/3826/3832 at max. 500 mm centres. Wall fix with SG Smart Fix. Silent Gliss Wave option is available. Compliant to Child Safety legislation EN 13120.

SV

Silent Gliss SG 3840 lindragssystem. Består av aluminiumprofil SG 3841 i specificerad längd i vitlack, alu natur eller angiven RAL färg. 14 st 11300 SILENT TRACK glid per meter. Takmonteras med fäste SG 3825 c/c 500 mm. Vägmontering med SG Smart Fix c/c 500 mm. Uppfyller barnsäkerhetsnorm EN 13120. Kan användas med system Wave.

NO

Silent Gliss SG 3840 Snortrekksystem. Består av aluminiumprofil SG 3841 i spesifisert lengde. Hvitlakkert, alu natur eller spesifisert RAL farge. 14 stk SG 11300 SILENT TRACK glidere pr meter. Takmonteres med feste SG 3825 c/c 500 mm. Veggmontering med SG Smart Fix c/c 500 mm. Oppfyller kravene i barnesikkerhetsnormen EN13120. kan brukes med Wave system.

DA

Silent Gliss SG 3840 gardinskinnesystem med snortræk. Består af en aluminiumprofil SG 3841 i ønsket længde, sølvanodiseret eller hvid pulverlakering. Leveres med 14 stk. 2C glidere SG 11300 pr m. Loftmonteres med spændebøjle SG 3825/3826/3832 med højst 500 mm afstand. Vægmonteres med SG Smart Fix. Kan bruges med Silent Gliss Wave. Overholder lovgivning om børnesikkerhed efter EN 13120.

FITTING

A. FITTING INFORMATION

For detailed fitting information, visit the Silent Gliss website.

Fixing Points

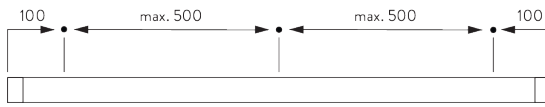

B. CEILING FITTING

Clamp SG 3825

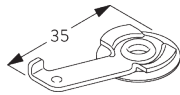
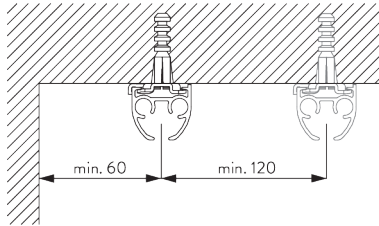

SG 3825

Clamp

Bracket SG 3832

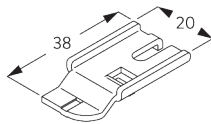
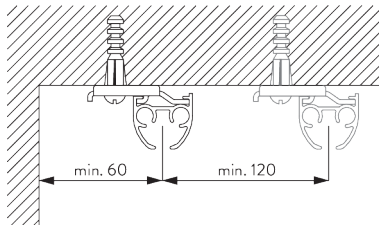

SG 3832

Bracket

Bracket SG 3826

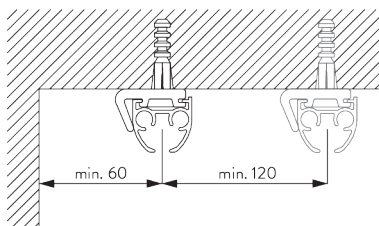

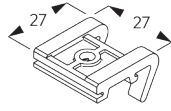

SG 3826
Bracket

C. WALL FITTING

Smart Fix

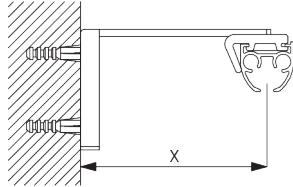

Smart Fix SG 11200 - SG 11205 and bracket SG 3826:
Screw SG 10492 (M4x8) needed.

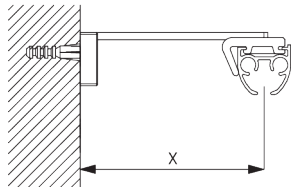

Square Smart Fix SG 11210 - SG 11215 and bracket SG 3826:
Screw SG 10492 (M4x8) needed.

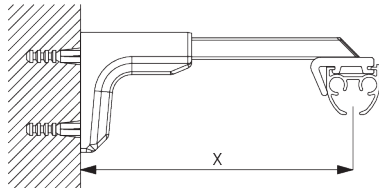

Universal Smart Fix SG 11154 - SG 11156 and bracket SG 3826:
Screw SG 10277 (M4x12) needed.

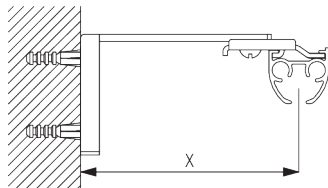

Smart Fix SG 11200 - SG 11205 and bracket SG 3832:
Screw SG 10492 (M4x8) needed.

Smart Fix	X mm (SG 3826 / SG 3825)	X mm (SG 3832)
SG 11200 / SG 11210	52	70
SG 11201 / SG 11211	72	90
SG 11202 / SG 11212	92	110
SG 11203 / SG 11213	112	130
SG 11204 / SG 11214	142	160
SG 11205 / SG 11215	192	210
SG 11154	102-130	120-148
SG 11155	132-160	150-178
SG 11156	182-210	200-228

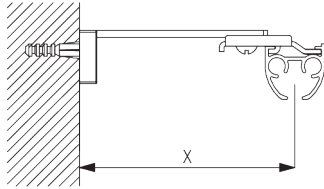

Square Smart Fix SG 11210 - SG 11215 and bracket SG 3832:

Screw SG 10492 (M4x8) needed.

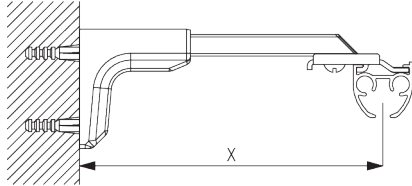

Universal Smart Fix SG 11154 - SG 11156 and bracket SG 3832:

Screw SG 10407 (M4x10) needed.

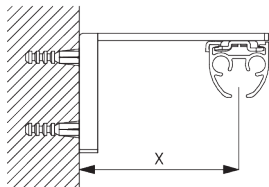

Smart Fix SG 11200 - SG 11205 and clamp SG 3825:

Screw SG 10074 (M4x8) needed.

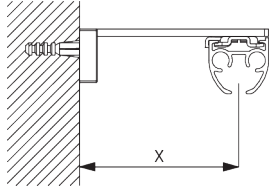

Square Smart Fix SG 11210 - SG 11215 and clamp SG 3825:

Screw SG 10074 (M4x8) needed.

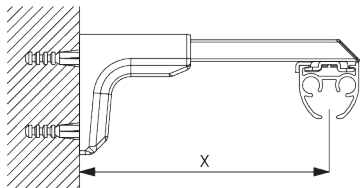

Universal Smart Fix SG 11154 - SG 11156 and clamp SG 3825:

Screw SG 11158 (M4x12) needed.

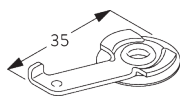

SG 3825
Clamp

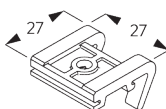

SG 3826
Bracket

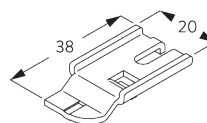

SG 3832
Bracket



SG 10074
Countersunk head screw
M4x8



SG 10277
Pan head screw M4x12



SG 10407
Pan head screw M4x10



SG 10492
Pan head screw M4x8



SG 11158
Countersunk head screw
M4x12

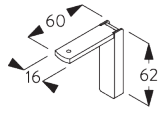

SG 11200
Smart Fix 60 mm

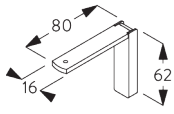

SG 11201
Smart Fix 80 mm

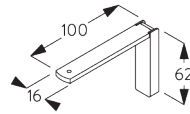

SG 11202
Smart Fix 100 mm

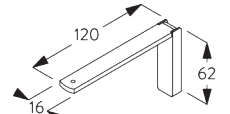

SG 11203
Smart Fix 120 mm

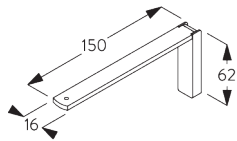

SG 11204
Smart Fix 150 mm

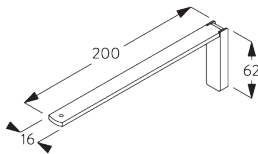

SG 11205
Smart Fix 200 mm

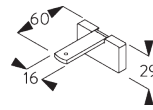

SG 11210
Square Smart Fix 60 mm

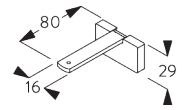

SG 11211
Square Smart Fix 80 mm

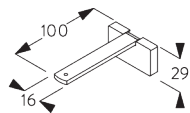

SG 11212
Square Smart Fix 100 mm

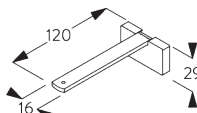

SG 11213
Square Smart Fix 120 mm

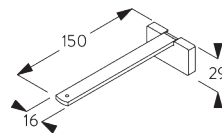

SG 11214
Square Smart Fix 150 mm

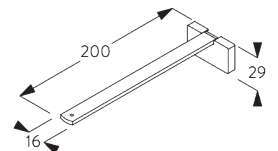

SG 11215
Square Smart Fix 200 mm

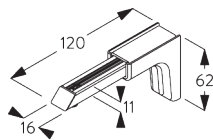

SG 11154
Universal Smart Fix 120 mm

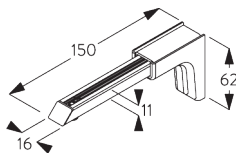

SG 11155
Universal Smart Fix 150 mm

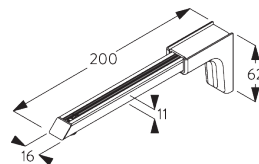

SG 11156
Universal Smart Fix 200 mm

Bracket SG 3836

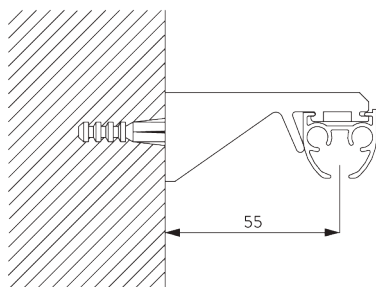

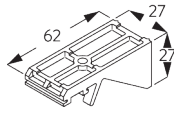

SG 3836
Bracket

SYSTEM OPTIONS

A. WAVE

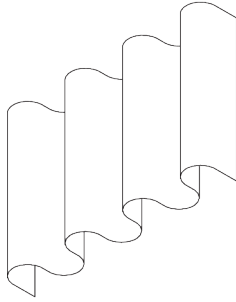

SG 11295

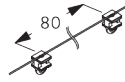

SG 11302

Standard components:

- SG 11295 End stop
- SG 11302 Wave 2C glider cord 80 mm

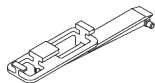

SG 6364



SG 6365

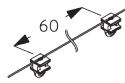

SG 11303

Optional components (min. radius >30 cm):

- SG 6364 Wave extension
- SG 6365 Wave hanger
- SG 11303 Wave 2C glider Cord 60 mm



SG 3582

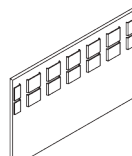

SG 6349

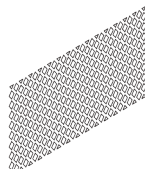

SG 6363

Curtain components:

- SG 3582 Hook
- SG 6349 Wave curtain tape
- SG 6363 Wave top hemming tape
- SG 10075 Lead weight 50 gr/m
- SG 10076 Fabric weight

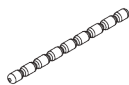

SG 10075



SG 10076

Wave stack depth - 2C glider cord (standard components)

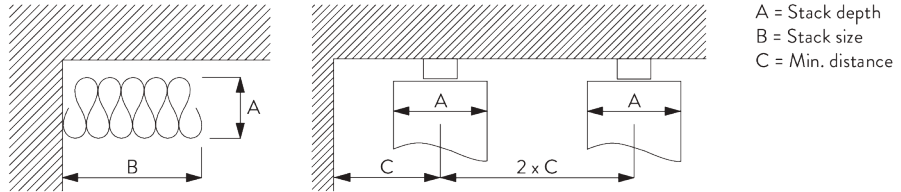

2C Glider cord SG 11302	Pockets between hooks	Approx. curtain fullness	Stack depth A	Stack size B*	Min distance C
80	6	~2.1	140	180 per metre of track	90
80	7	~2.3	160	180 per metre of track	100

2C Glider cord SG 11303	Pockets between hooks	Approx. curtain fullness	Stack depth A	Stack size B*	Min distance C
60	4	~2.1	100	230 per metre of track	70
60	5	~2.3	120	230 per metre of track	80

**Stack size B standard*





- single stack = plus 130 mm per curtain
- pair stack = plus 30 mm per curtain

**Stack size B optional*





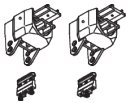
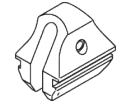
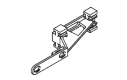
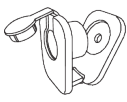





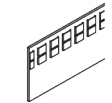

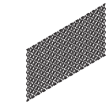

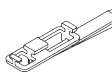

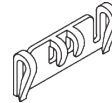

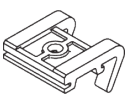

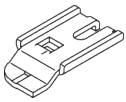
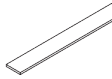
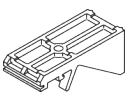
- single stack = plus 200 mm per curtain
- pair stack = plus 200 mm per curtain

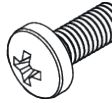
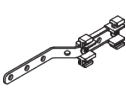
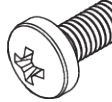
PARTS

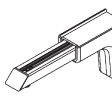
A. STANDARD PARTS

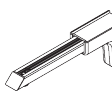
	SG 3090 Cord ø 3.5 mm
	SG 3825 Clamp
	SG 3841 Profile
	SG 3845 Cord guide set
	SG 6086 Spring stop
	SG 6288 Overlap arm
	SG 10731 Child safety retainer set
	SG 11300 2C glider

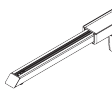
B. OPTIONAL PARTS

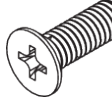
	SG 3340 Cord/chain weight		SG 6349 Wave curtain tape
	SG 3581 Hook		SG 6363 Wave top hemming tape
	SG 3582 Hook		SG 6364 Wave extension
	SG 3735 Cord weight with tensioner		SG 6365 Wave hanger
	SG 3802 Connection bridge		SG 10074 Countersunk head screw M4x8
	SG 3826 Bracket		SG 10075 Lead weight 50 g/m
	SG 3832 Bracket		SG 10076 Fabric weight
	SG 3836 Bracket		SG 10277 Pan head screw M4x12
	SG 6053 Spring stop		SG 10407 Pan head screw M4x10
	SG 6063 Overlap arm		SG 10492 Pan head screw M4x8
	SG 6065 End stop		SG 11154 Universal Smart Fix 120 mm
	SG 6094 Roller		SG 11155 Universal Smart Fix 150 mm
	SG 6098 Roller		SG 11156 Universal Smart Fix 200 mm
	SG 6283 Roller		SG 11158 Countersunk head screw M4x12



SG 11200
Smart Fix 60 mm

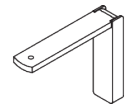

SG 11201
Smart Fix 80 mm

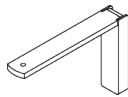

SG 11202
Smart Fix 100 mm

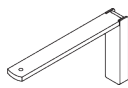

SG 11203
Smart Fix 120 mm



SG 11204
Smart Fix 150 mm



SG 11205
Smart Fix 200 mm

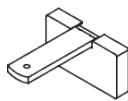

SG 11210
Square Smart Fix 60 mm

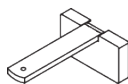

SG 11211
Square Smart Fix 80 mm

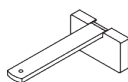

SG 11212
Square Smart Fix 100 mm

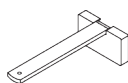

SG 11213
Square Smart Fix 120 mm

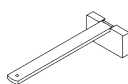

SG 11214
Square Smart Fix 150 mm

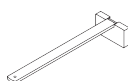

SG 11215
Square Smart Fix 200 mm

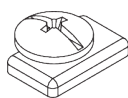

SG 11295
End stop



SG 11301
2C glider on strip

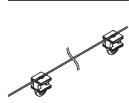

SG 11302
Wave 2C glider cord 80 mm

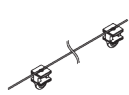

SG 11303
Wave 2C glider cord 60 mm

SG 3870

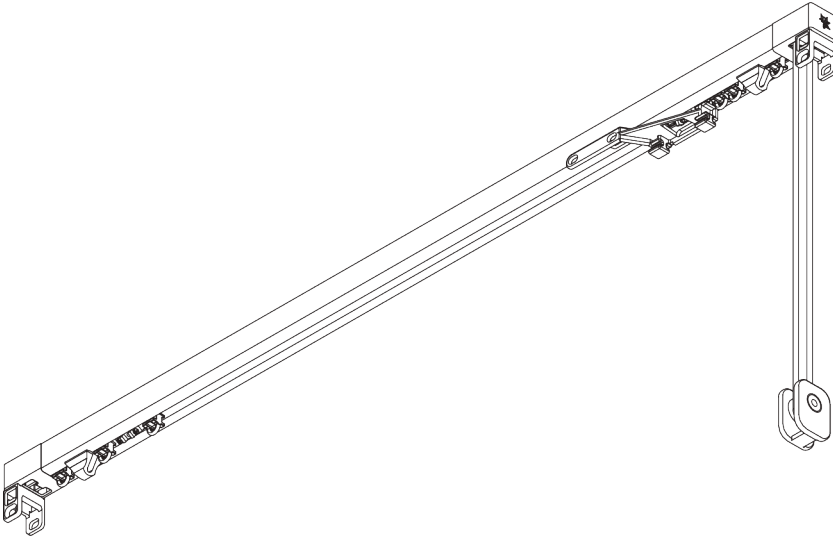
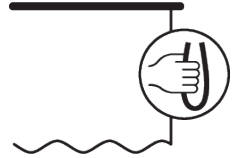

PRODUCT INFORMATION

- **Operation:** cord
- **Range:** M - L
- **Fitting:** ceiling, wall, recess
- **Colours:** white RAL 9016, black RAL 9005 or anodised aluminum, special colours possible (recess profile only in white RAL 9016, black RAL 9005 or special color)
- **Fabrics:** refer to Silent Gliss fabric collection

Features:

- 2-component (2C) glider technology
- Wave (2C)
- Bendable
- Bendable recess profile

SYSTEM SPECIFICATIONS

A. SYSTEM DIMENSIONS



6 m

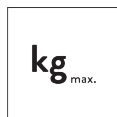

14 kg

Max. curtain weight - 2C glider or roller

	2 m	4 m	6 m
	12	11	10
	14	13	12
	9	8	7
	10	9	6
	6	5	4
	7	6	5
	5	4	3
	6	5	4

(kg max.)

Max. curtain weight - Wave 2C glider cord

	2 m	4 m	6 m
	5	8	7
	5	8	8
	5	6	5
	5	6	6
	4	3	-
	4	4	3
	3	2	-
	3	3	-

(kg max.)

B. PROFILE

Profile and bending information

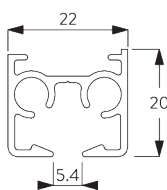

SG 11190

Profile

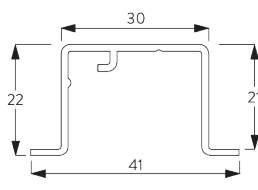

SG 11230

Recess profile



C. HOW TO MEASURE

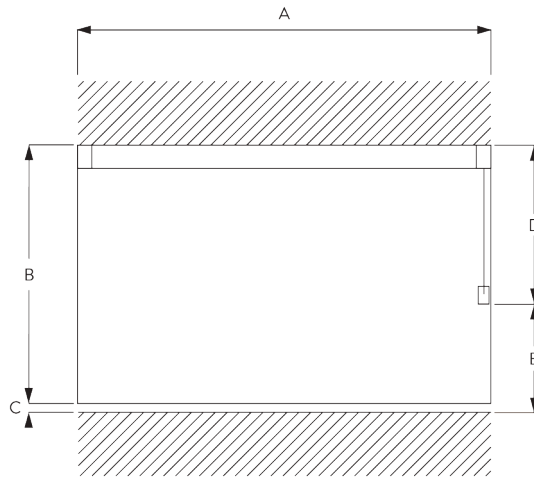

- A: System width
- B: System height
- C: Distance between floor and fabric
- D: Cord height
- E: Safety Retainer SG 10731 min. 150 cm above floor

D. SPECIFICATION TEXT

EN

Silent Gliss SG 3870 Cord Operated Curtain Track System. Comprising aluminium profile SG11190 supplied made to measure in silver anodised or powder coated in white. Supplied with 2C gliders SG 11300 at 14/m. Top fixed with fixing clamp SG 3825/3826/3832 at max. 500 mm centres. Wall fix with SG Smart Fix. Optional recess profile SG 11230. Silent Gliss Wave option is available. Compliant to Child Safety legislation EN 13120.

SV

Silent Gliss SG 3870 lindragssystem. Består av aluminiumprofil SG 11190 i specificerad längd i vitlack, alu natur eller angiven RAL färg. 14 st 11300 SILENT TRACK glid per meter. Takmonteras med fäste SG 3825 c/c 500 mm. Vägghäring med SG Smart Fix c/c 500 mm. Kan levereras med infällningsprofil SG 11230. Uppfyller barnsäkerhetsnorm EN 13120. Kan användas med system Wave.

NO

Silent Gliss SG 3870 Snortrekksystem. Består av aluminiumprofil SG 11190 i spesifisert lengde. Hvitlakkert, alu natur eller spesifisert RAL farge. 14 stk SG 11300 SILENT TRACK glidere pr meter. Takmonteres med feste SG 3825 c/c 500 mm. Veggmontering med SG Smart Fix c/c 500 mm. Kan leveres med profil for innfelling SG 11230. Oppfyller kravene i barnesikkerhetsnormen EN13120. kan brukes med Wave system.

DA

Silent Gliss SG 3870 gardinskinnesystem med snortræk. Består af aluminiumprofil SG11190 i ønsket længde, sølv-anodiseret eller hvid pulverlakering. Leveres med 14 stk. 2C glidere SG 11300 pr. m. Loftmonteres med spændebøjle SG 3825/3826/3832 med højst 500 mm afstand. Vægmonteres med SG Smart Fix. Kan leveres med indfældningsprofil SG 11230. Kan bruges med Silent Gliss Wave. Overholder lovgivning om barnesikkerhed efter EN 13120.

FITTING

A. FITTING INFORMATION

Fixing points

For detailed fitting information, visit the Silent Gliss website.

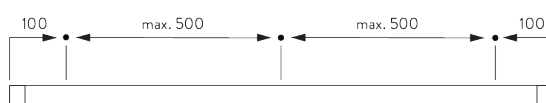

B. CEILING FITTING

Clamp SG 3825

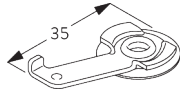
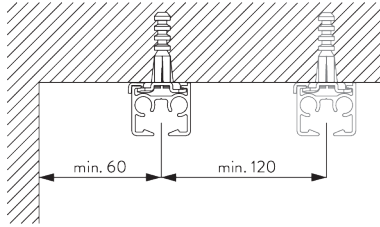

SG 3825

Clamp

Bracket SG 3826

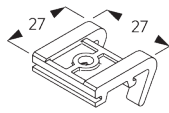
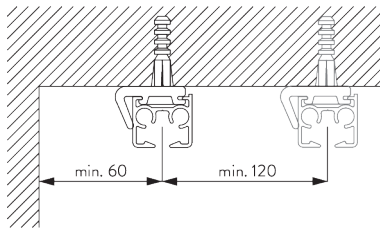

SG 3826

Bracket

Bracket SG 3832

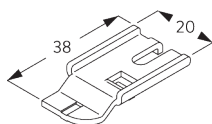
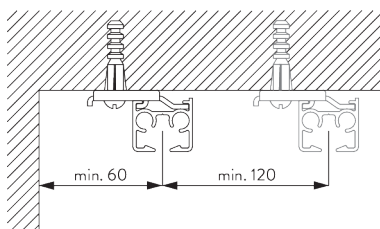

SG 3832

Bracket

C. WALL FITTING

Smart Fix

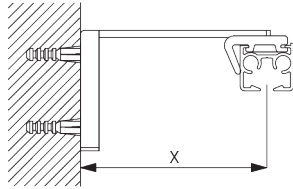

Smart Fix SG 11200 - SG 11205 and bracket SG 3826:
Screw SG 10492 (M4x8) needed.

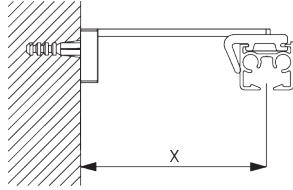

Square Smart Fix SG 11210 - SG 11215 and bracket SG 3826:
Screw SG 10492 (M4x8) needed.

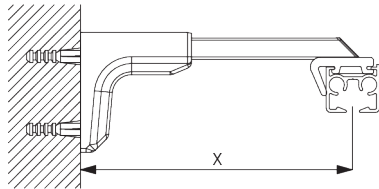

Universal Smart Fix SG 11154 - SG 11156 and bracket SG 3826:
Screw SG 10277 (M4x12) needed.

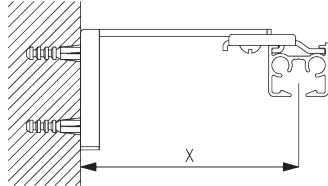

Smart Fix SG 11200 - SG 11205 and bracket SG 3832:
Screw SG 10492 (M4x8) needed.

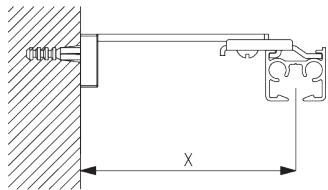

Square Smart Fix SG 11210 - SG 11215 and bracket SG 3832:
Screw SG 10492 (M4x8) needed.

Smart Fix	X mm (SG 3826 / SG 3825)	X mm (SG 3832)
SG 11200 / SG 11210	52	70
SG 11201 / SG 11211	72	90
SG 11202 / SG 11212	92	110
SG 11203 / SG 11213	112	130
SG 11204 / SG 11214	142	160
SG 11205 / SG 11215	192	210
SG 11154	102-130	120-148
SG 11155	132-160	150-178
SG 11156	182-210	200-228

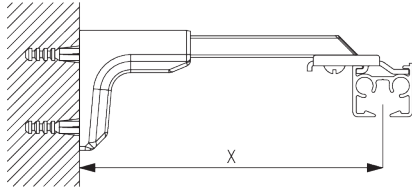

Universal Smart Fix SG 11154 - SG 11156 and bracket SG 3832:

Screw SG 10407 (M4x10) needed.

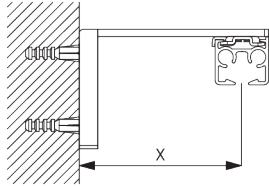

Smart Fix SG 11200 - SG 11205 and clamp SG 3825:

Screw SG 10074 (M4x8) needed.

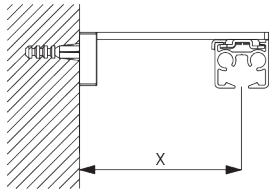

Square Smart Fix SG 11210 - SG 11215 and clamp SG 3825:

Screw SG 10074 (M4x8) needed.

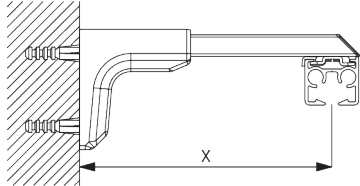

Universal Smart Fix SG 11154 - SG 11156 and clamp SG 3825:

Screw SG 11158 (M4x12) needed.

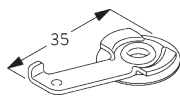

SG 3825

Clamp

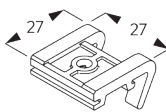

SG 3826

Bracket

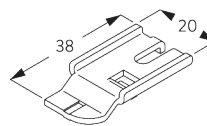

SG 3832

Bracket



SG 10074

Countersunk head screw
M4x8



SG 10277

Pan head screw M4x12



SG 10407

Pan head screw M4x10



SG 10492

Pan head screw M4x8



SG 11158

Countersunk head screw
M4x12

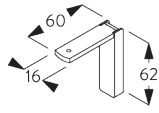

SG 11200
Smart Fix 60 mm

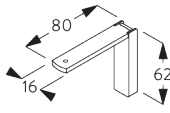

SG 11201
Smart Fix 80 mm

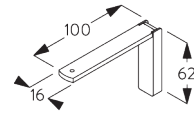

SG 11202
Smart Fix 100 mm

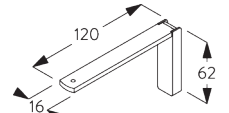

SG 11203
Smart Fix 120 mm

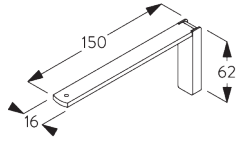

SG 11204
Smart Fix 150 mm

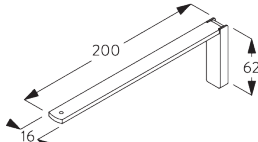

SG 11205
Smart Fix 200 mm

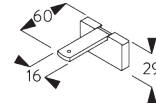

SG 11210
Square Smart Fix 60 mm

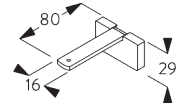

SG 11211
Square Smart Fix 80 mm

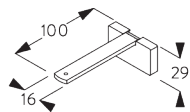

SG 11212
Square Smart Fix 100 mm

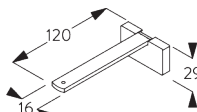

SG 11213
Square Smart Fix 120 mm

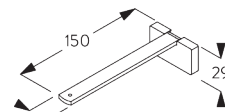

SG 11214
Square Smart Fix 150 mm

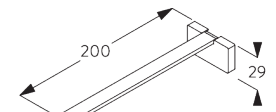

SG 11215
Square Smart Fix 200 mm

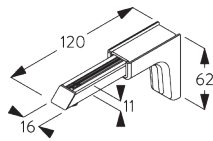

SG 11154
Universal Smart Fix 120 mm

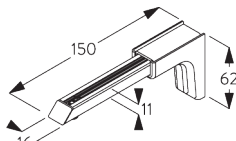

SG 11155
Universal Smart Fix 150 mm

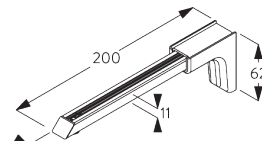

SG 11156
Universal Smart Fix 200 mm

Bracket SG 3836

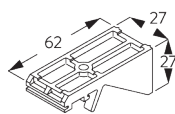
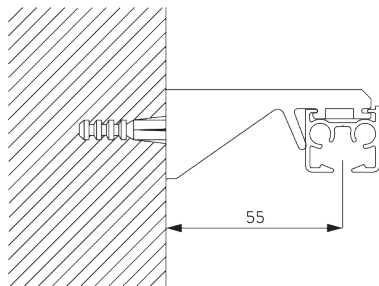

SG 3836
Bracket

D. RECESS FITTING

Recess profile
SG 11230

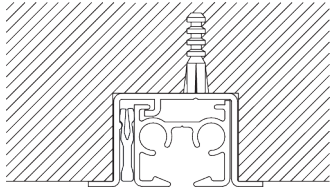

One wedge SG 10157 per fixing point.
For detailed recess fitting, visit the Silent Gliss website.

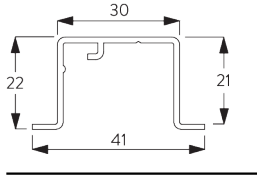

SG 11230
Recess profile

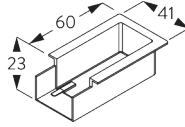

SG 11238
Recess Mask

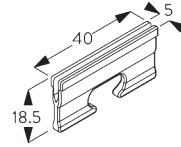

SG 10157
Wedge

SYSTEM OPTIONS

A. WAVE

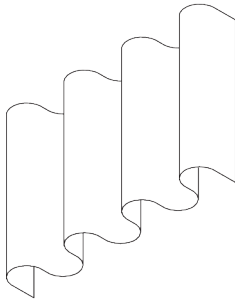

SG 11295

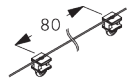

SG 11302

Standard components:

- SG 11295 End stop
- SG 11302 Wave 2C glider cord 80 mm

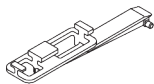

SG 6364



SG 6365

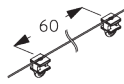

SG 11303

Optional components:

- SG 6364 Wave extension
- SG 6365 Wave hanger
- SG 11303 Wave 2C glider Cord 60 mm

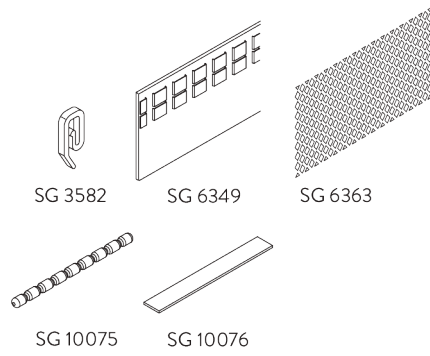

Curtain components:

- SG 3582 Hook
- SG 6349 Wave curtain tape
- SG 6363 Wave top hemming tape
- SG 10075 Lead weight 50 gr/m
- SG 10076 Fabric weight

Wave stack depth - 2C glider cord (standard components)

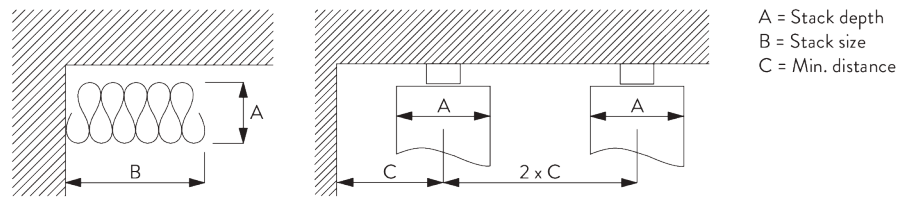

A = Stack depth
 B = Stack size
 C = Min. distance

2C Glider cord SG 11302	Pockets between hooks	Approx. curtain fullness	Stack depth A	Stack size B*	Min distance C
80	6	~2.1	140	180 per metre of track	90
80	7	~2.3	160	180 per metre of track	100

2C Glider cord SG 11303	Pockets between hooks	Approx. curtain fullness	Stack depth A	Stack size B*	Min distance C
60	4	~2.1	100	230 per metre of track	70
60	5	~2.3	120	230 per metre of track	80

***Stack size B standard**







- single stack = plus 130 mm per curtain
- pair stack = plus 30 mm per curtain

***Stack size B optional**



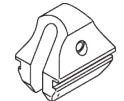
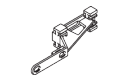
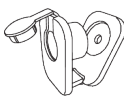







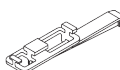

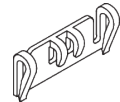

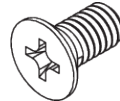
- single stack = plus 200 mm per curtain
- pair stack = plus 200 mm per curtain

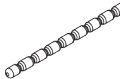
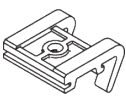
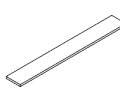
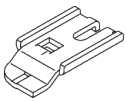
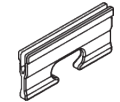
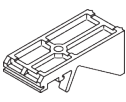
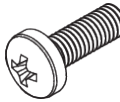
PARTS

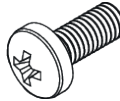
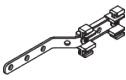
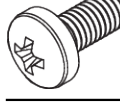
A. STANDARD PARTS

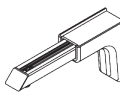
	SG 3090 Cord ø 3.5 mm
	SG 3825 Clamp
	SG 6086 Spring stop
	SG 6288 Overlap arm
	SG 10731 Child safety retainer set
	SG 11190 Profile
	SG 11285 Guide set
	SG 11300 2C glider

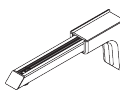
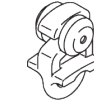
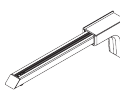
B. OPTIONAL PARTS

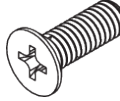
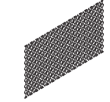
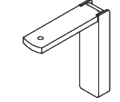
	SG 3340 Cord/chain weight		SG 6364 Wave extension
	SG 3582 Hook		SG 6365 Wave hanger
	SG 3735 Cord weight with tensioner		SG 10074 Countersunk head screw M4x8
	SG 3802 Connection bridge		SG 10075 Lead weight 50 g/m
	SG 3826 Bracket		SG 10076 Fabric weight
	SG 3832 Bracket		SG 10157 Wedge
	SG 3836 Bracket		SG 10277 Pan head screw M4x12
	SG 6053 Spring stop		SG 10407 Pan head screw M4x10
	SG 6063 Overlap arm		SG 10492 Pan head screw M4x8
	SG 6094 Roller		SG 11154 Universal Smart Fix 120 mm
	SG 6098 Roller		SG 11155 Universal Smart Fix 150 mm
	SG 6283 Roller		SG 11156 Universal Smart Fix 200 mm
	SG 6349 Wave curtain tape		SG 11158 Countersunk head screw M4x12
	SG 6363 Wave top hemming tape		SG 11200 Smart Fix 60 mm

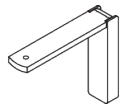

SG 11201
Smart Fix 80 mm

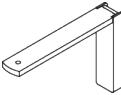

SG 11202
Smart Fix 100 mm

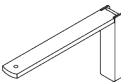

SG 11203
Smart Fix 120 mm

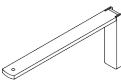

SG 11204
Smart Fix 150 mm

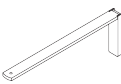

SG 11205
Smart Fix 200 mm

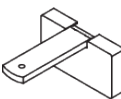

SG 11210
Square Smart Fix 60 mm

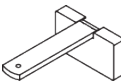

SG 11211
Square Smart Fix 80 mm

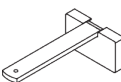

SG 11212
Square Smart Fix 100 mm

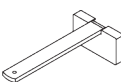

SG 11213
Square Smart Fix 120 mm

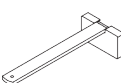

SG 11214
Square Smart Fix 150 mm

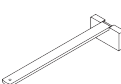

SG 11215
Square Smart Fix 200 mm

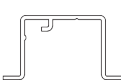

SG 11230
Recess profile

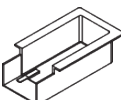

SG 11238
Recess Mask

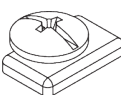

SG 11295
End stop



SG 11301
2C glider on strip

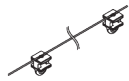

SG 11302
Wave 2C glider cord 80 mm

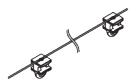

SG 11303
Wave 2C glider cord 60 mm

SG 3970

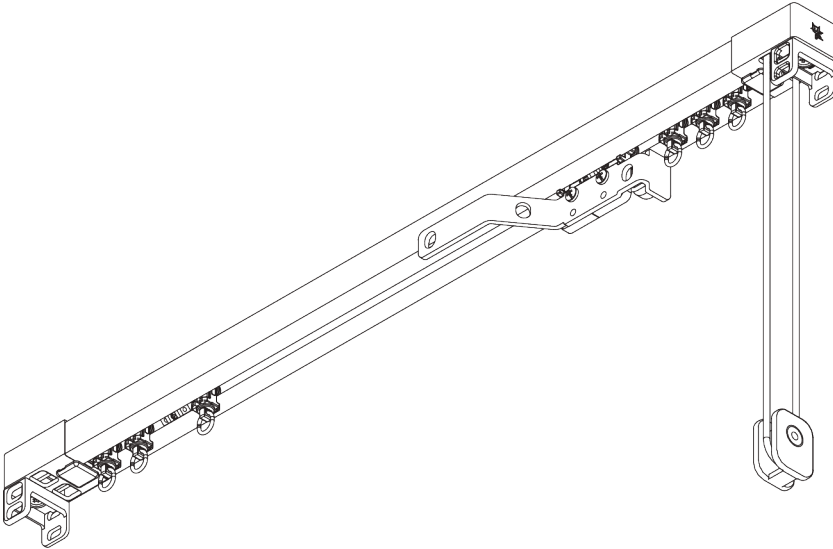
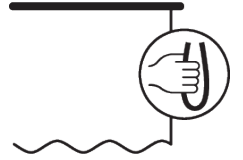

PRODUCT INFORMATION

- **Operation:** cord
- **Range:** M - L
- **Fitting:** ceiling, wall, recess
- **Colours:** white RAL 9016 or anodised aluminum, special colours possible (recess profile only in white RAL 9016 or special color)
- **Fabrics:** refer to Silent Gliss fabric collection

Features:

- 2-component (2C) roller technology
- Wave (2C)
- Bendable
- Bendable recess profile

SYSTEM SPECIFICATIONS

A. SYSTEM DIMENSIONS

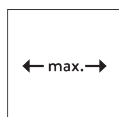

15 m

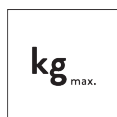

38 kg

Max. curtain weight - 2C roller

	2 m	4 m	6 m	8 m	10 m	12 m	15 m
	25	38	35	30	25	20	15
	25	38	35	30	25	20	15
	25	30	25	20	18	15	10
	25	30	25	20	18	15	10
	13	16	13	11	10	8	6
	13	16	13	11	10	8	6
	11	13	11	10	9	7	-
	11	13	11	10	9	7	-

(kg max.)

B. PROFILE

Profile and bending information

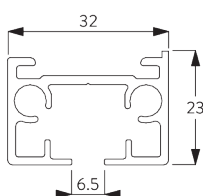

SG 3971

Profile

Radius: >25 cm

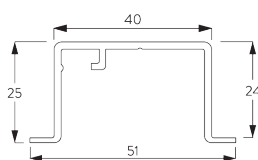

SG 10862

Recess profile

Radius: 50 - 75 cm
>75 cm on request

C. HOW TO MEASURE

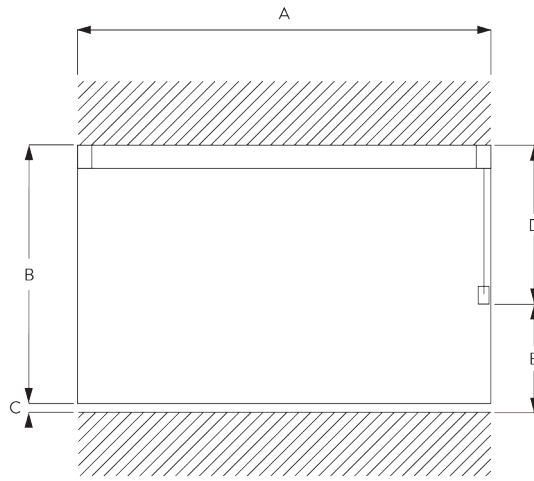

A: System width
B: System height
C: Distance between floor and fabric
D: Cord height
E: Safety Retainer SG 10731 min. 150 cm above floor

D. SPECIFICATION TEXT

EN

Silent Gliss SG 3970 Cord Operated Curtain Track System. Comprising aluminium profile SG 3971 supplied made to measure in silver anodised or powder coated in white. Supplied with 2C gliders SG 10840 at 10/m. Top fixed with fixing clamp SG 3041 / SG 3004 at max. 500 mm centres. Wall fix with SG Smart Fix. Optional recess profile SG 10862. Silent Gliss Wave option is available. Compliant to Child Safety legislation EN 13120.

SV

Silent Gliss SG 3870 lindragssystem. Består av aluminiumprofil SG 3971 i specificerad längd i vitlack, alu natur eller angiven RAL färg. 10 st 10840 SILENT TRACK glid per meter. Takmonteras med fäste SG 3041 / SG 3004 c/c 500 mm.

Väggmontering med SG Smart Fix c/c 500 mm. Kan leveres med infällningsprofil SG 10862. Uppfyller barnsäkerhetsnorm EN 13120. Kan användas med system Wave.

NO

Silent Gliss SG 3870 Snortrekksystem. Består av aluminiumprofil SG 3971 i spesifisert lengde. Hvitlakkert alu natur eller spesifisert RAL farge. 10 stk SG 10840 SILENT TRACK glidere pr meter. Takmonteres med feste SG 3041 / SG 3004 c/c 500 mm. Veggmontering med SG Smart Fix c/c 500 mm. Kan leveres med profil for innfelling SG 10862. Oppfyller kravene i barnesikkerhetsnormen EN 13120. kan brukes med Wave system.

DA

Silent Gliss SG 3970 gardinskinnesystem med snortræk. Består af en aluminiumprofil SG 3971 i ønsket længde, sølvanodiseret eller hvid pulverlakering. Leveres med 10 stk. 2C glidere SG 10840 pr m. Loftmonteres med spændebojle SG 3041 / SG 3004 med højst 500 mm afstand. Vægmonteres med SG Smart Fix. Kan leveres med indfældningsprofil SG 10862. Kan bruges med Silent Gliss Wave. Overholder lovgivning om børnesikkerhed efter EN 13120.

FITTING

A. FITTING INFORMATION

Fixing points

For detailed fitting information, visit the Silent Gliss website.

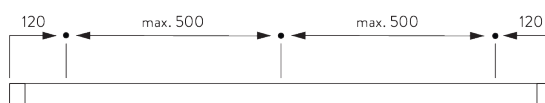

B. CEILING FITTING

Clamp SG 3004

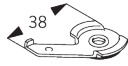
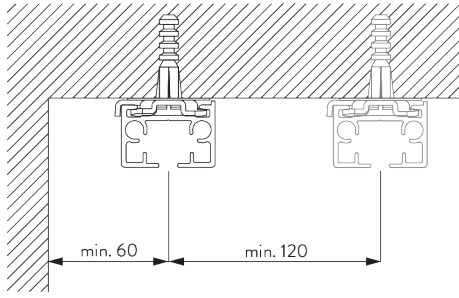

SG 3004

Clamp

Direct fitting

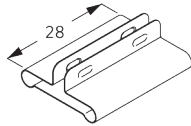
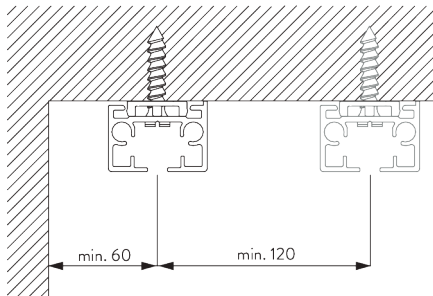

SG 7002

Profile protector

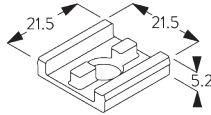

SG 10865

Support plate

Bracket SG 3041

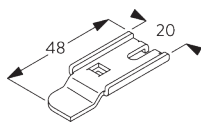
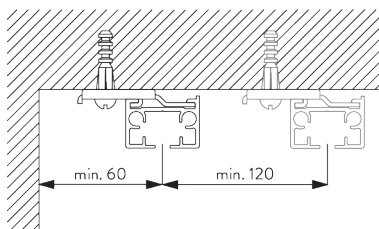

SG 3041

Bracket

C. WALL FITTING

Smart Fix

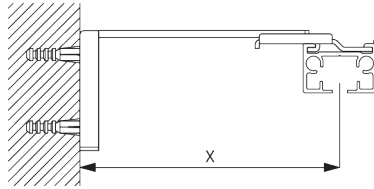

Smart Fix SG 11200 - SG 11205 and bracket SG 3041:
Screw SG 10492 (M4x8) needed.

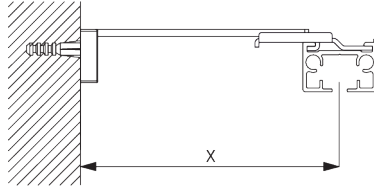

Square Smart Fix SG 11210 - SG 11215 and bracket SG 3041:
Screw SG 10492 (M4x8) needed.

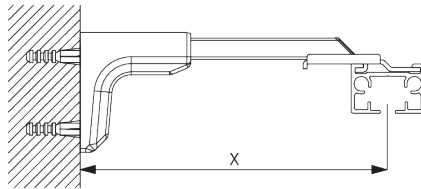

Universal Smart Fix SG 11154 - SG 11156 and bracket SG 3041:
Screw SG 10407 (M4x10) needed.

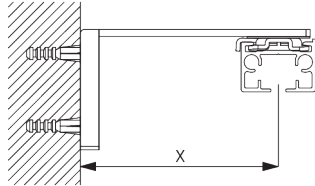

Smart Fix SG 11201 - SG 11205 and clamp SG 3004:
Screw SG 10074 (M4x8) needed.

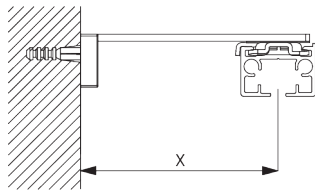

Square Smart Fix SG 11211 - SG 11215 and clamp SG 3004:
Screw SG 10074 (M4x8) needed.

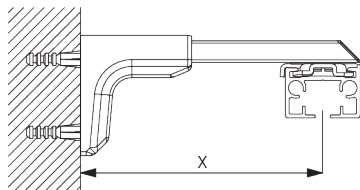

Universal Smart Fix SG 11154 - SG 11156 and clamp SG 3004:
Screw SG 11158 (M4x12) needed.

Smart Fix	X mm (SG 3041)	X mm (SG 3004)
SG 11200 / SG 11210	83	
SG 11201 / SG 11211	103	72
SG 11202 / SG 11212	123	92
SG 11203 / SG 11213	143	112
SG 11204 / SG 11214	173	142
SG 11205 / SG 11215	223	192
SG 11154	128-156	102-130
SG 11155	158-186	132-160
SG 11156	208-236	182-210

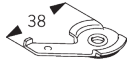

SG 3004
Clamp

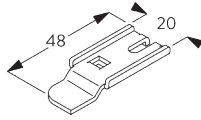

SG 3041
Bracket



SG 10074
Countersunk head screw
M4x8



SG 10407
Pan head screw M4x10



SG 10492
Pan head screw M4x8



SG 11158
Countersunk head screw
M4x12

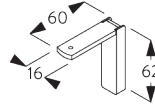

SG 11200
Smart Fix 60 mm

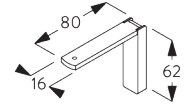

SG 11201
Smart Fix 80 mm

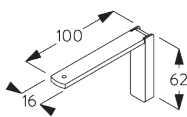

SG 11202
Smart Fix 100 mm

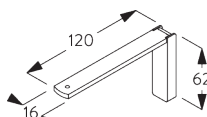

SG 11203
Smart Fix 120 mm

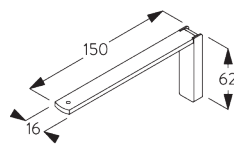

SG 11204
Smart Fix 150 mm

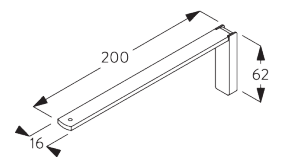

SG 11205
Smart Fix 200 mm

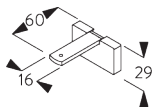

SG 11210
Square Smart Fix 60 mm

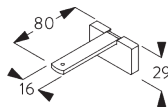

SG 11211
Square Smart Fix 80 mm

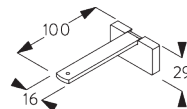

SG 11212
Square Smart Fix 100 mm

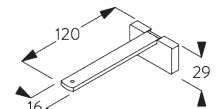

SG 11213
Square Smart Fix 120 mm

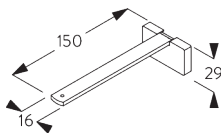

SG 11214
Square Smart Fix 150 mm

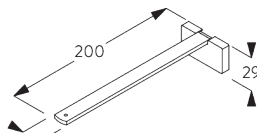

SG 11215
Square Smart Fix 200 mm

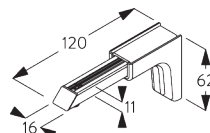

SG 11154
Universal Smart Fix 120 mm

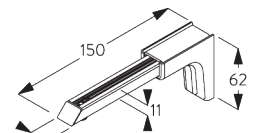

SG 11155
Universal Smart Fix 150 mm

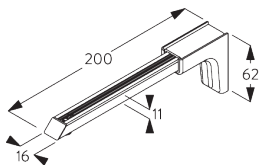

SG 11156
Universal Smart Fix 200 mm

D. RECESS FITTING

Recess profile SG 10862

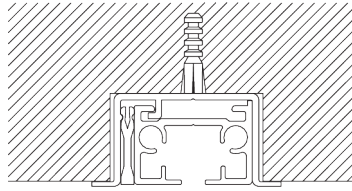

One wedge SG 5118 per fixing point.
For detailed recess fitting, visit the Silent Gliss website.

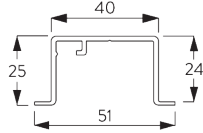

SG 10862
Recess profile

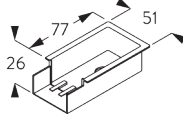

SG 10864
Recess mask

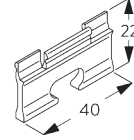

SG 5118
Wedge

SYSTEM OPTIONS

A. WAVE

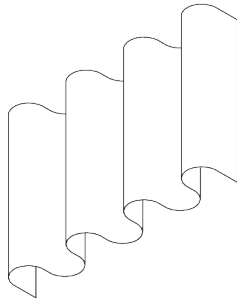

SG 11295

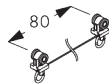

SG 10852



SG 6365

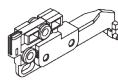

SG 10845



SG 10854



SG 10867

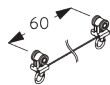

SG 10869

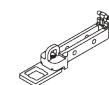

SG 10887

Standard components:

- SG 11295 End stop
- SG 10852 Wave 2C roller cord 80 mm

Optional components:

- SG 6365 Wave hanger
- SG 10845 Wave master carrier single stack 80 mm
- SG 10854 Wave overlap support arm
- SG 10867 Panhead screw M4x16
- SG 10869 Wave 2C roller cord 60 mm (no single stack)
- SG 10887 Wave extension

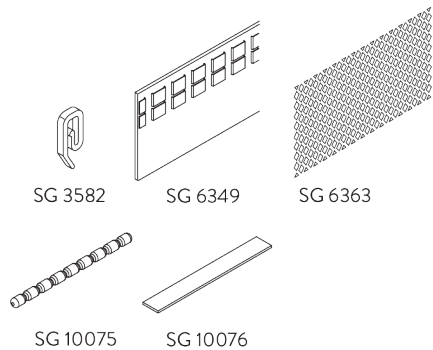

Curtain components:

- SG 3582 Hook
- SG 6349 Wave curtain tape
- SG 6363 Wave top hemming tape
- SG 10075 Lead weight 50 gr/m
- SG 10076 Fabric weight

Wave stack depth - 2C roller cord (standard components)

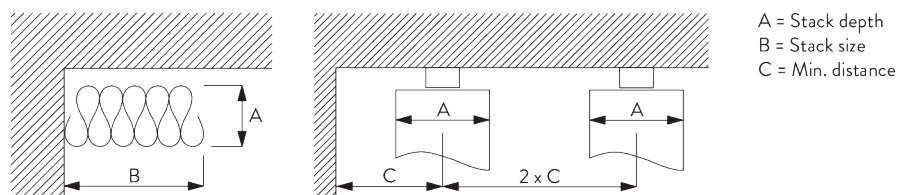

2C Roller cord SG 10852	Pockets between hooks	Approx. curtain fullness	Stack depth A	Stack size B*	Min distance C
80	6	~2.1	140	210 per metre of track	90
80	7	~2.3	160	210 per metre of track	100

2C Roller cord SG 10869	Pockets between hooks	Approx. curtain fullness	Stack depth A	Stack size B*	Min distance C
60	4	~2.1	100	260 per metre of track	70
60	5	~2.3	120	260 per metre of track	80

***Stack size B standard**







- single stack = plus 140 mm per curtain
- pair stack = plus 40 mm per curtain

***Stack size B optional**



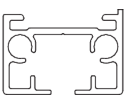
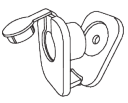
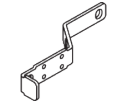
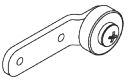

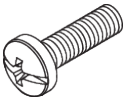
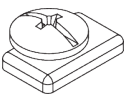

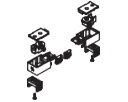

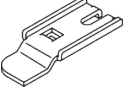

- single stack = n/a
- pair stack = plus 150 mm per curtain

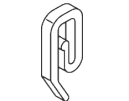

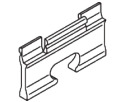
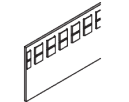
PARTS

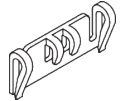
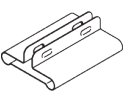
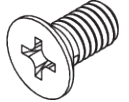
A. STANDARD PARTS

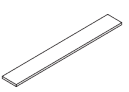
	SG 3004 Clamp
	SG 3090 Cord ø 3.5 mm
	SG 3971 Profile
	SG 10731 Child safety retainer set
	SG 10821 Overlap arm
	SG 10826 Overlap arm support
	SG 10840 2C roller
	SG 10923 Pan head screw Freedriv M4x12
	SG 11295 End stop
	SG 11314 Master carrier
	SG 11315 Guide set

B. OPTIONAL PARTS

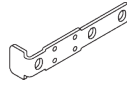
	SG 3041 Bracket
	SG 3340 Cord/chain weight
	SG 3582 Hook
	SG 3735 Cord weight with tensioner
	SG 5118 Wedge
	SG 6349 Wave curtain tape
	SG 6363 Wave top hemming tape
	SG 6365 Wave hanger
	SG 7002 Profile protector
	SG 10074 Countersunk head screw M4x8
	SG 10075 Lead weight 50 g/m
	SG 10076 Fabric weight
	SG 10407 Pan head screw M4x10
	SG 10492 Pan head screw M4x8

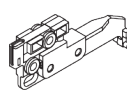
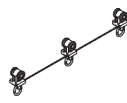
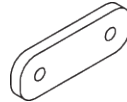
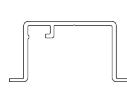
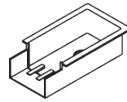
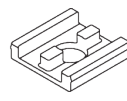
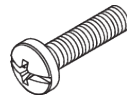
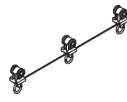
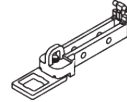
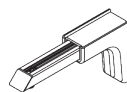
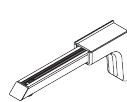
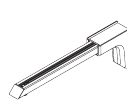
	SG 10820 Overlap arm
	SG 10831 Connection bridge
	SG 10845 Wave master carrier 80 mm
	SG 10852 Wave 2C roller cord 80 mm
	SG 10854 Wave overlap plate
	SG 10862 Recess profile
	SG 10864 Recess mask
	SG 10865 Support plate
	SG 10867 Pan head screw Freedriv M4x16
	SG 10869 Wave 2C roller cord 60 mm
	SG 10887 Wave extension
	SG 11154 Universal Smart Fix 120 mm
	SG 11155 Universal Smart Fix 150 mm
	SG 11156 Universal Smart Fix 200 mm

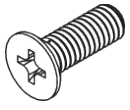

SG 11158

Countersunk head screw M4x12

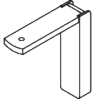

SG 11200

Smart Fix 60 mm

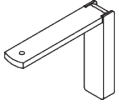

SG 11201

Smart Fix 80 mm

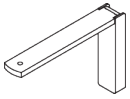

SG 11202

Smart Fix 100 mm

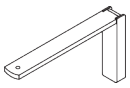

SG 11203

Smart Fix 120 mm

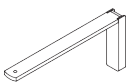

SG 11204

Smart Fix 150 mm

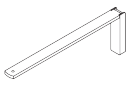

SG 11205

Smart Fix 200 mm

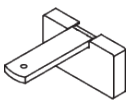

SG 11210

Square Smart Fix 60 mm

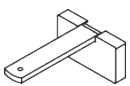

SG 11211

Square Smart Fix 80 mm

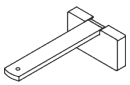

SG 11212

Square Smart Fix 100 mm

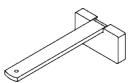

SG 11213

Square Smart Fix 120 mm

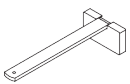

SG 11214

Square Smart Fix 150 mm

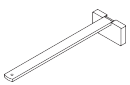

SG 11215

Square Smart Fix 200 mm

The Architects of Silence

Silent Gliss is the leading global supplier of premium interior window treatments. Since 1952 we have been tirelessly committed to the development of the worlds` smoothest, quietest systems using state of the art technology.

Driven by customer needs, Silent Gliss offers functional and durable products. Expert technical advice coupled with installation and support services complete the offer. Silent Gliss stands for innovative, sustainable, tailor made solutions, exceptional design and first-class quality.

Silent Gliss Nordic AB

Travbanegatan 9
213 77 Malmö
Sweden
T +46 40 55 52 50
info@silentgliss.se

Byggdøy Allé 111A
0273 Oslo
Norway
T +47 24 11 80 60
info@silentgliss.no

Denmark
T +45 36 77 67 00
info@silentgliss.dk

silentgliss.se
silentgliss.no
silentgliss.dk