

SG 6103

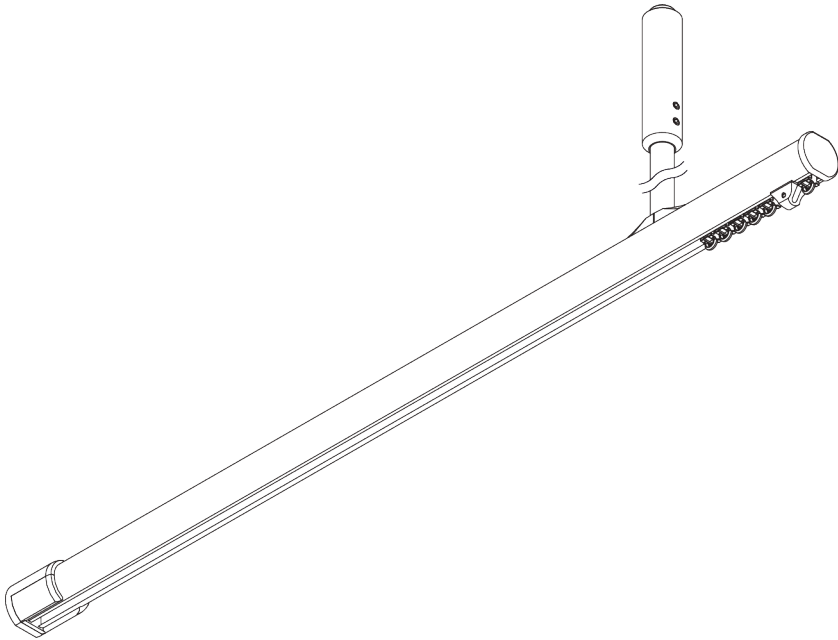

PRODUCT INFORMATION

- **Operation:** hand
- **Range:** S - L
- **Fitting:** suspended, ceiling, wall
- **Colours:** white RAL 9016 or anodised aluminum, special colours possible
- **Fabrics:** refer to Silent Gliss fabric collection

Features:

- Universal room divider
- 2-component (2C) glider technology
- Wave (2C)
- Suspended
- Versatile layouts
- Bendable

SYSTEM SPECIFICATIONS

A. PROFILE

Profile and bending information

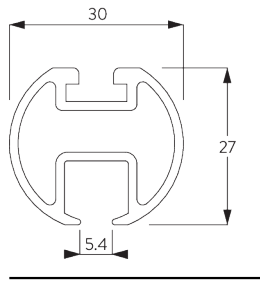

SG 6103p

Profile

Radius: >25 cm

B. HOW TO MEASURE

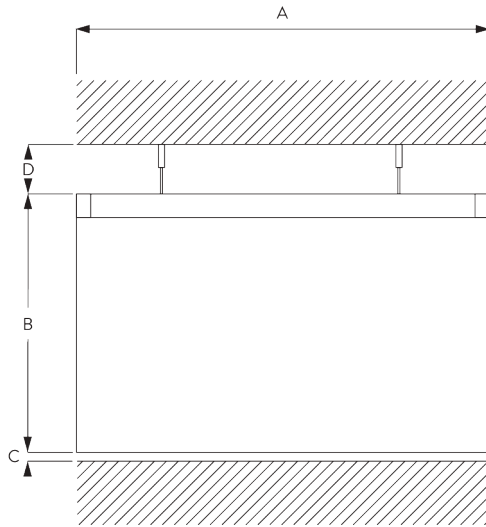

A: System width

B: System height

C: Distance between floor and fabric

D: Distance between ceiling and system

C. SPECIFICATION

TEXT

EN

Silent Gliss SG 6103 Cubicle Curtain Track System. Comprises aluminium profile SG 6103 supplied made to measure in silver anodised or powder coated in white. 2 stops SG 6065. 2 End caps SG 6630. Supplied with 2C gliders SG 11300/SG 6145 with hooks at 14/m. Top fixed with SG 6124//SG 6190 at 800-3000 mm centres. Wall fixed with SG Smart Fix at 800-3000 mm centres.

SV

Silent Gliss SG 6103 dusch/draperi system. Består av aluminiumprofil SG 6103 i specificerad längd i vitlack, alu natur eller angiven RAL färg. 14 st 11300 SILENT TRACK glid/SG 6145 glid m krok per meter. 2 SG 6065 vridstopp. Ändskydd SG 6630. Takmonteras med fäste SG 6124/SG 6190 c/c 800-3000 mm. Vägghontering med SG Smart Fix c/c 800-3000 mm.

NO

Silent Gliss SG 6103 Dusj- og Cubiclesystem. Består av aluminiumprofil SG 6103 i spesifisert lengde. Hvitlakkert eller alu natur eller spesifisert RAL farge. 14 stk SG 11300 SILENT TRACK glider/SG 6145 glider m/krok pr meter. 2 stk SG6065 vridstopp. Endelukk SG6630 Takmonteres med feste SG 6124/SG6190 c/c 800-3000 mm. Veggmontering med SG Smart Fix c/c 800-1500 mm.

DA

Silent Gliss SG 6103 gardinskinnesystem til kabiner. Består af en aluminiumprofil SG 6103 i ønsket længde, sølvanodiseret eller hvid pulverlakering. 2 stop SG 6065. 2 endelåg SG 6630. Leveres med 14 stk. 2C glidere SG 11300/SG 6145 pr m. Loftmonteres med SG 6124//SG 6190 i afstande på 800-3000 mm. Vægmonteres med SG Smart Fix med en afstand på 800-3000 mm.

FITTING

A. FITTING INFORMATION

Fixing points

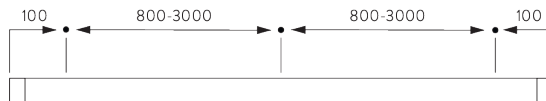

For detailed fitting information, visit the Silent Gliss website.

Dust Cover

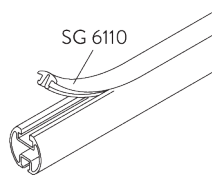

B. CEILING FITTING

Hanger SG 6190 / SG 6196

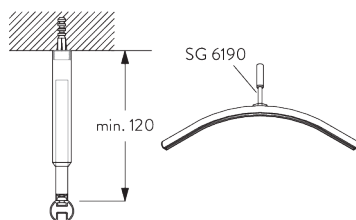

Or variant with SG 6196 double hanger.

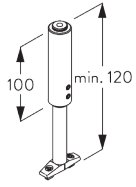

SG 6190
Hanger

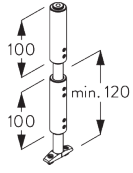

SG 6196
Double hanger

Mini hanger SG 6175

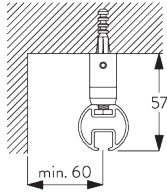

SG 6175
Mini hanger

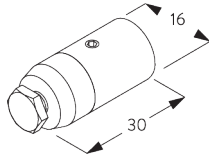

Bracket SG 6124

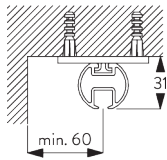

SG 6124
Bracket

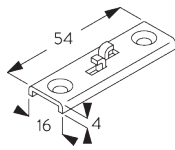

V-hanger

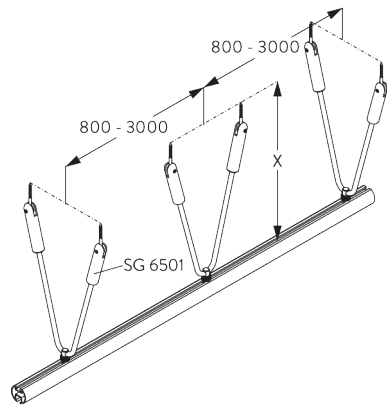

SG 6501:

V-hangers (25°-35°) provide additional lateral stability.

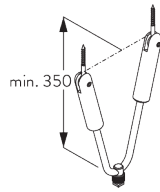

SG 6501

V-Hanger

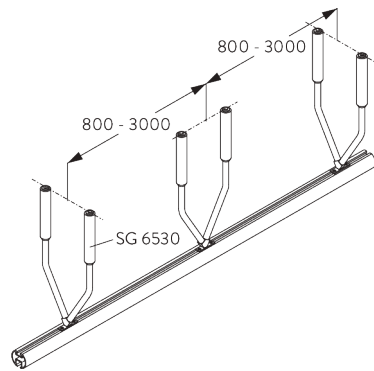

SG 6530:

V-hangers (25°-35°) provide additional lateral stability.

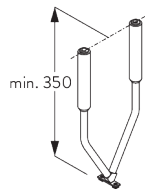

SG 6530

V-Hanger

C. WALL FITTING

Smart Fix

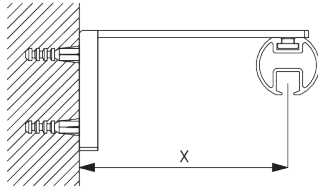

Smart Fix with slot SG 11206 - SG 11208:
Screw SG 10492 (M4x8) needed.

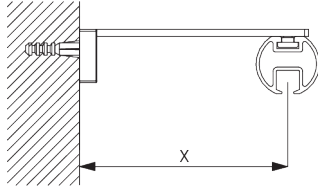

Square Smart Fix with slot SG 11216 - SG 11218:
Screw SG 10492 (M4x8) needed.

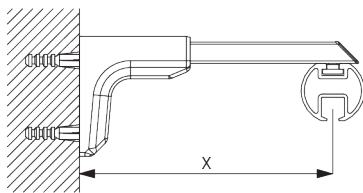

Universal Smart Fix SG 11154 - SG 11156:
Screw SG 11131 (M4x6) needed.

Smart Fix	X mm
SG 11206 / SG 11216	33-51
SG 11207 / SG 11217	53-71
SG 11208 / SG 11218	73-91
SG 11154	102-130
SG 11155	132-160
SG 11156	182-210

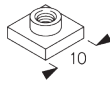

SG 6117

Slot nut



SG 10492

Pan head screw M4x8



SG 11131

Pan head screw with flange
M4x6

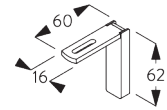

SG 11206

Smart Fix with slot 60 mm

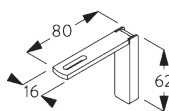

SG 11207

Smart Fix with slot 80 mm

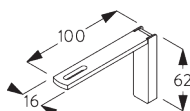

SG 11208

Smart Fix with slot 100 mm

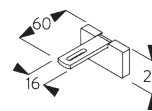

SG 11216

Square Smart Fix with slot 60
mm

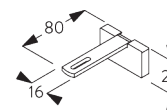

SG 11217

Square Smart Fix with slot 80
mm

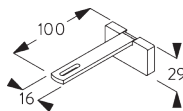

SG 11218

Square Smart Fix with slot
100 mm

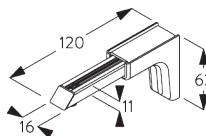

SG 11154

Universal Smart Fix 120 mm

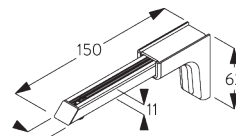

SG 11155

Universal Smart Fix 150 mm

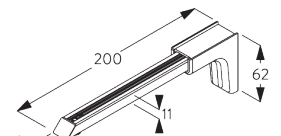

SG 11156

Universal Smart Fix 200 mm

D. WALL SUPPORT

Bracket SG 6620

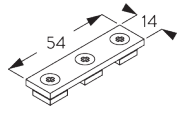
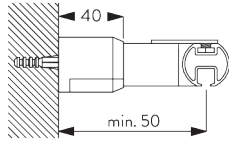

SG 6123

Connection plate

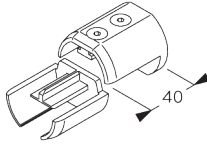

SG 6620

Wall bracket

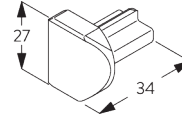

SG 6631

Connection piece

E. PROFILE JUNCTIONS

Connection bridge SG 6521

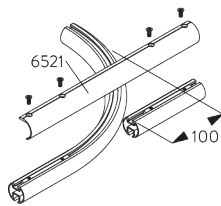
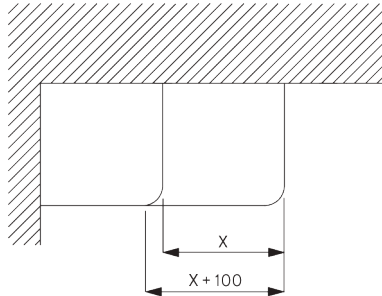

Note: be sure to attach a sketch!

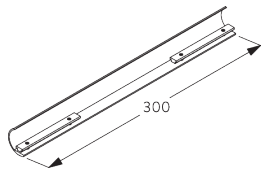

SG 6521

Connection bridge

Connection set SG 6635

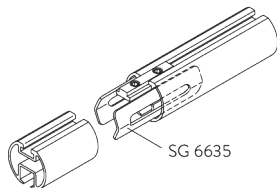

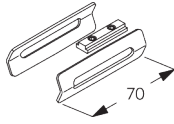

SG 6635

Connection bridge set

SYSTEM OPTIONS

A. LAYOUT OPTIONS

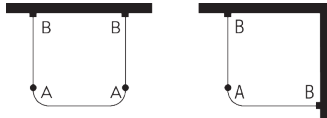

A: Hanger rod
B: Wall support

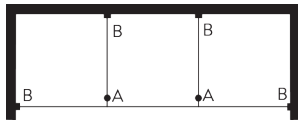

A: Hanger rod
B: Wall support

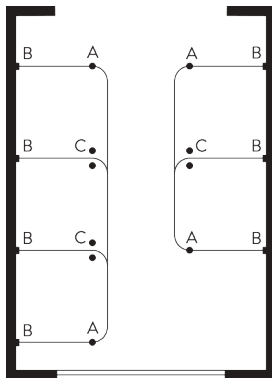

A: Hanger rod
B: Wall support
C: V-hanger

B. WAVE

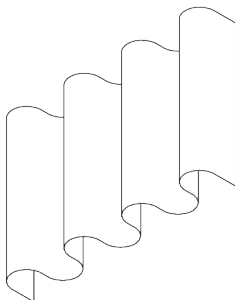

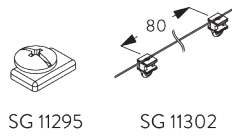

SG 11295

SG 11302

Standard components:

- SG 11295 End stop
- SG 11302 Wave 2C glider cord 80 mm

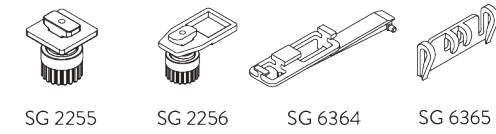

SG 2255

SG 2256

SG 6364

SG 6365

Optional components:

- SG 2255 Brake
- SG 2256 Brake
- SG 6364 Wave extension
- SG 6365 Wave hanger
- SG 6366 Wave carrier for draw rod
- SG 10430-34 Draw rod
- SG 11303 Wave 2C glider cord 60 mm



SG 6366

SG 10430-34

SG 11303

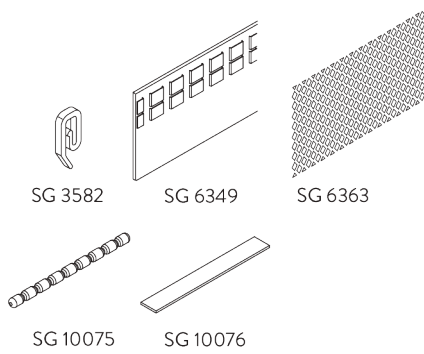

SG 3582

SG 6349

SG 6363

SG 10075

SG 10076

Curtain components:

- SG 3582 Hook
- SG 6349 Wave curtain tape
- SG 6363 Wave top hemming tape
- SG 10075 Lead weight 50 gr/m
- SG 10076 Fabric weight

Wave stack depth - 2C glider cord (standard components)

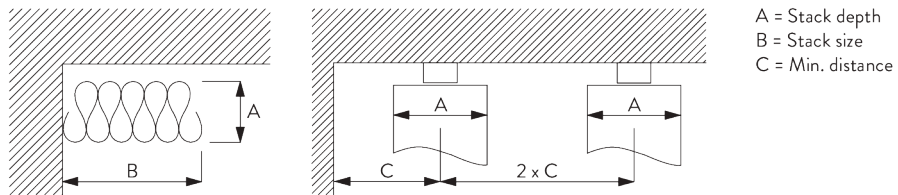

2C Glider cord SG 11302	Pockets between hooks	Approx. curtain fullness	Stack depth A	Stack size B*	Min distance C
80	6	~2.1	140	180 per metre of track	90
80	7	~2.3	160	180 per metre of track	100

2C Glider cord SG 11303	Pockets between hooks	Approx. curtain fullness	Stack depth A	Stack size B*	Min distance C
60	4	~2.1	100	230 per metre of track	70
60	5	~2.3	120	230 per metre of track	80

*Stack size B when using optional extension arm increases by 150 mm per curtain stack!

PARTS

A. STANDARD PARTS

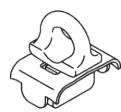

SG 6065
End stop

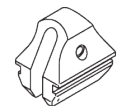

SG 6086
Spring stop



SG 6103p
Profile

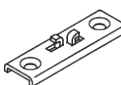

SG 6124
Bracket

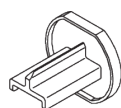

SG 6630
End cover

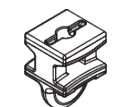

SG 11300
2C glider

B. OPTIONAL PARTS

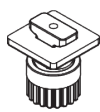

SG 2255
Brake

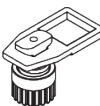

SG 2256
Brake



SG 3582
Hook



SG 6053
Spring stop



SG 6094
Roller



SG 6098
Roller



SG 6110
Dust cover



SG 6117
Slot nut

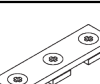

SG 6123
Connection plate

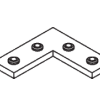

SG 6125
Corner connection piece

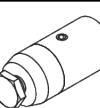

SG 6175
Mini hanger



SG 6190
Hanger

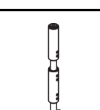

SG 6196
Double hanger

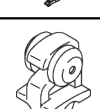

SG 6283
Roller

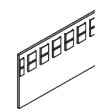

SG 6349
Wave curtain tape



SG 6363
Wave top hemming tape

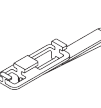

SG 6364
Wave extension

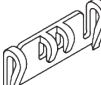

SG 6365
Wave hanger

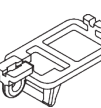

SG 6366
Wave carrier for draw rod



SG 6501
V-Hanger

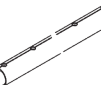

SG 6521
Connection bridge



SG 6530
V-Hanger

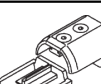

SG 6620
Wall bracket

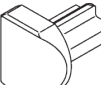

SG 6631
Connection piece

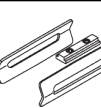

SG 6635
Connection bridge set

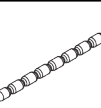

SG 10075
Lead weight 50 g/m

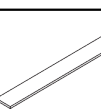

SG 10076
Fabric weight

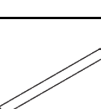

SG 10430
Draw rod 50 cm

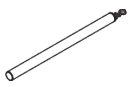

SG 10431

Draw rod 75 cm

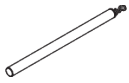

SG 10432

Draw rod 100 cm

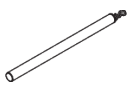

SG 10433

Draw rod 125 cm

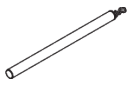

SG 10434

Draw rod 150 cm

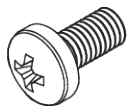

SG 10492

Pan head screw M4x8



SG 11131

Pan head screw with flange M4x6

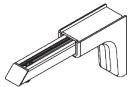

SG 11154

Universal Smart Fix 120 mm

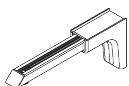

SG 11155

Universal Smart Fix 150 mm

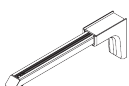

SG 11156

Universal Smart Fix 200 mm

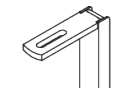

SG 11206

Smart Fix with slot 60 mm

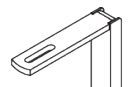

SG 11207

Smart Fix with slot 80 mm

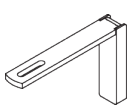

SG 11208

Smart Fix with slot 100 mm



SG 11216

Square Smart Fix with slot 60 mm

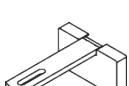

SG 11217

Square Smart Fix with slot 80 mm

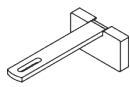

SG 11218

Square Smart Fix with slot 100 mm

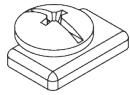

SG 11295

End stop



SG 11301

2C glider on strip

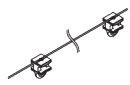

SG 11302

Wave 2C glider cord 80 mm

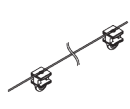

SG 11303

Wave 2C glider cord 60 mm

