

# DIM-OUT BLIND SYSTEMS

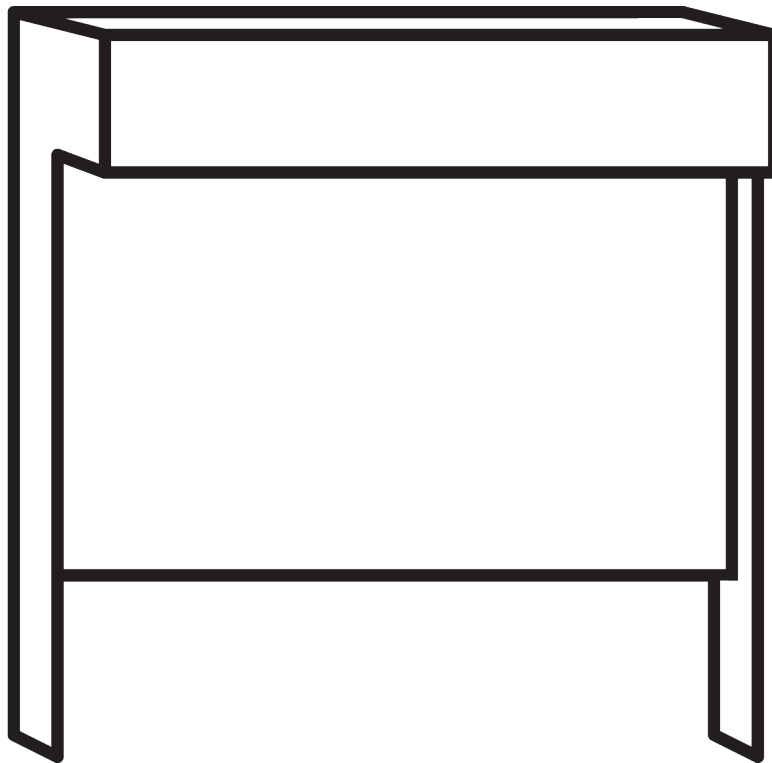

# GENERAL NOTES

## **Dimensions**

- Measurements are in mm except where indicated.
- Max. kg relates to fabric incl. accessories (bottom bars, etc.).







## **Fitting**

- Installation by qualified fitter only.
- Number of brackets and fitting positions / fixing points vary depending on fitting surface, system weight, fabric make-up, screw / fixing type and obstacles.
- Qualified fitter must use appropriate screws / fixings for each situation.
- Profile lip if applicable to be installed to room side.
- Electrical installations must be carried out according to Silent Gliss wiring diagrams and conform to local regulations.
- Check space for cables and plugs!

## **Child Safety**

- All relevant Silent Gliss systems correspond to child safety EN 13120.
- All parties involved must comply with EN 13120.

# APPLICATION CHART

<u>PAGE</u>	<u>SYSTEM</u>	<u>OPERATION</u>	<u>DIMENSION</u>	← max. →	↑ max. ↓	kg <sub>max.</sub>
5	<b>SG 4710</b>		S	1.6 m	1.6 m	2 kg
13	<b>SG 4730</b>		M	2.2 m	2.4 m	3.7 kg
21	<b>SG 4740</b>		L	3 m	3 m	6 kg
29	<b>SG 4760</b>		S	1.6 m	1.6 m	2 kg
39	<b>SG 4770</b>		M	2.2 m	2.4 m	3.7 kg
49	<b>SG 4780</b>		L	3 m	3 m	6 kg



# SG 4710

---

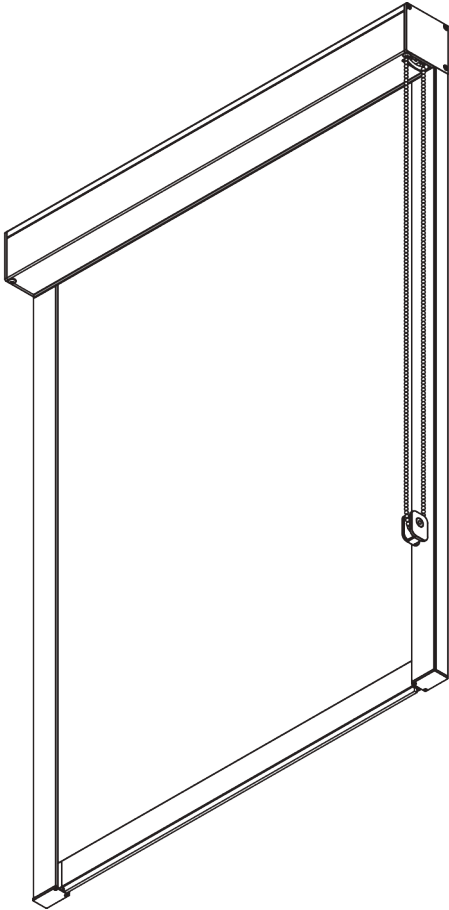
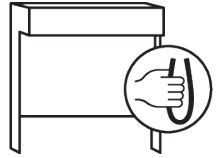

## PRODUCT INFORMATION

- **Operation:** chain
- **Range:** S
- **Fitting:** ceiling, wall, recess
- **Colours:** white RAL 9016 or black RAL 9005, special colours possible
- **Fabrics:** refer to Silent Gliss fabric collection

### **Features:**

- Zip technology
- Stainless steel bead chain
- 2-to-1 gear drive
- 40 mm side channel, pre-drilled fixing points

# SYSTEM SPECIFICATIONS

## A. SYSTEM DIMENSIONS

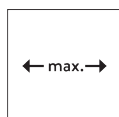

1.6 m

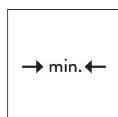

65 cm

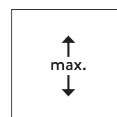

1.6 m

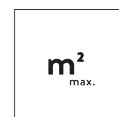

2.5 m<sup>2</sup>

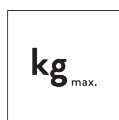

2 kg

## B. PROFILE

### Profile information

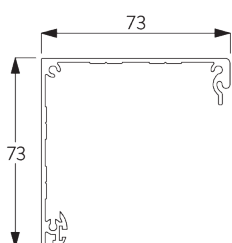

**SG 10994**

Box case 73 mm

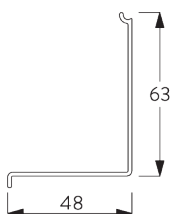

**SG 10995**

Box cover 73 mm

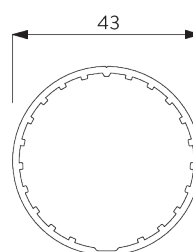

**SG 10532**

Tube ø 43 mm

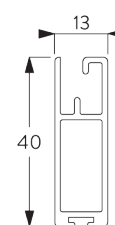

**SG 10993**

Bottom bar

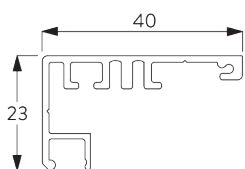

**SG 11418**

Side guide case

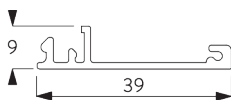

**SG 11419**

Side guide cover

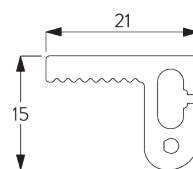

**SG 11421**

Zip profile

## C. HOW TO MEASURE

### Inside fitting

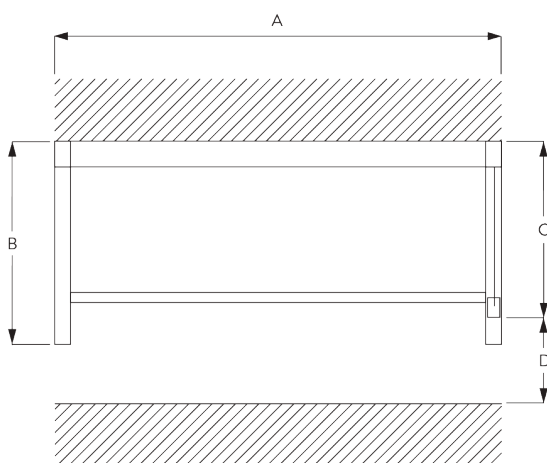

A: System width

B: System height

C: Chain height

D: Safety Retainer SG 10731 min. 150 cm above floor

## Face fitting

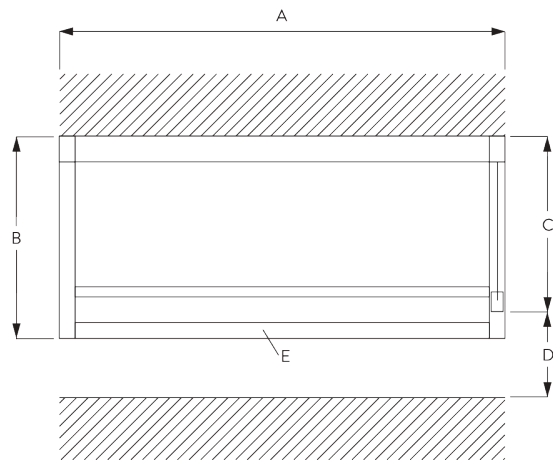

- A: System width
- B: System height
- C: Chain height
- D: Safety Retainer SG 10731 min. 150 cm above floor
- E: Optional: end profile (SG 11418 / SG 11419)

## D. SPECIFICATION

### TEXT

#### **EN**

Silent Gliss SG 4710 Chain Operated Dim-Out Roller Blind System. For blinds up to 1.6 m wide by 1.6 m drop, max 2.5sq m. Supplied complete and made to measure comprising aluminium headbox SG 10994-5 (73 mm), side profiles SG 11418 / SG 11419 and bottom hem bar SG 10993 in white or black powder coat finish as standard. Fabric edges retained by two component zip profile SG 11421. Operation by stainless steel bead chain with chain retainer SG 10731. Compliant to Child Safety Legislation EN 13120.

#### **SV**

Silent Gliss SG 4710 mörkläggningsrullgardin med kulkedja. För system max 1,6 x 1,6 m, eller totalt max 2,5 m<sup>2</sup>. Levereras komplett i kundmått bestående av toppkassett i aluminium SG 10994-5 (73 mm), sidoprofiler SG 11418 / SG 11419 samt tyngdprofil SG 10993 i vit eller svart epoxy lack. Textilens kant försedd med zip profil SG 11421. Manövrering med rostfri kulkedja av stål samt väggfäste SG 10731. Textil från Silent Gliss textilprogram i prisgrupp 1-3.

#### **NO**

Silent Gliss SG 4710 Mørkleggende rullegardin med kulekjede. For system inntil 1,6 x 1,6 m, eller totalt max 2,5 m<sup>2</sup>. Levereras komplett måltilpasset. Består av toppkasse i aluminium SG 10994-5 (73 mm), sideprofiler SG 11418 / SG 11419 samt tyngdeprofil SG 10993 i hvit eller svart epoxy lakk. Sidene på tekstile er festet med zip profil SG 11421. Betjening med rustriitt kulekjede samt veggfeste SG 10731. Tekstiler fra Silent Gliss tekstilkolleksjon i prisgrupp 1-3.

# FITTING

## A. FITTING INFORMATION

For detailed fitting information, visit the Silent Gliss website.

**Inside fitting - fixing points**

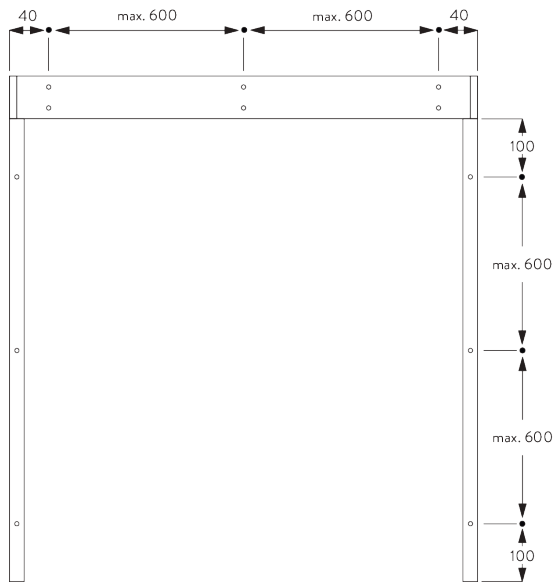

**Face fitting - fixing points**

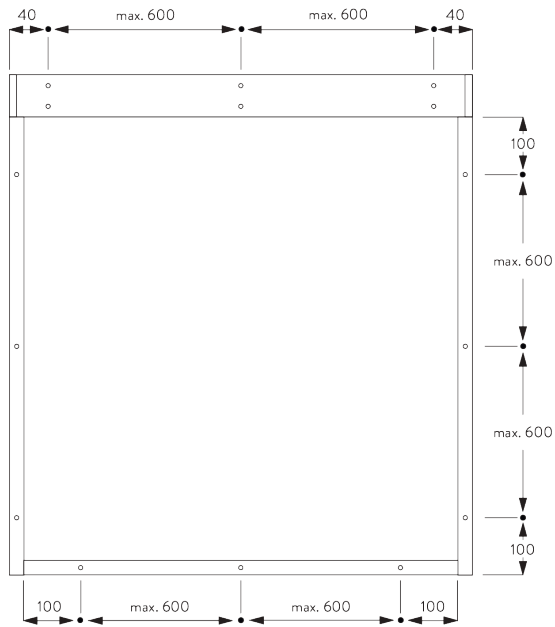

**B. CEILING FITTING**

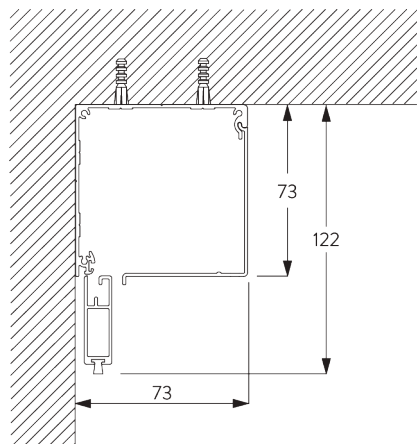



**C. WALL FITTING**

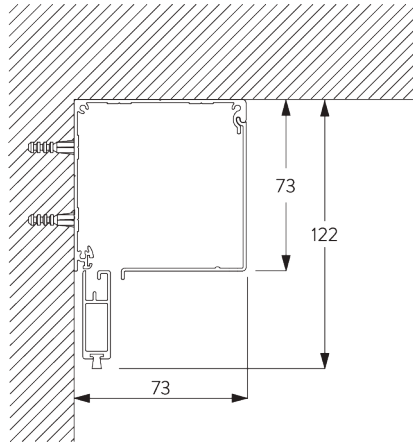

**D. RECESS FITTING**

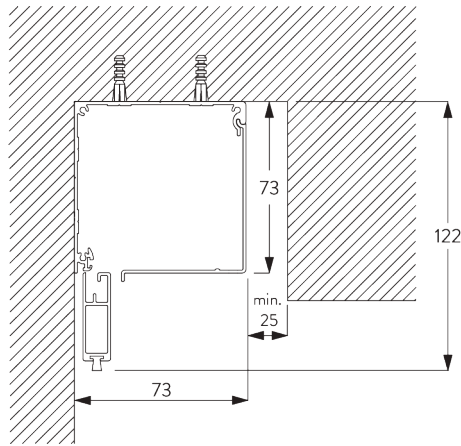

**E. SIDE PROFILES**  
**SG 11418 / SG 11419**

Inside fitting

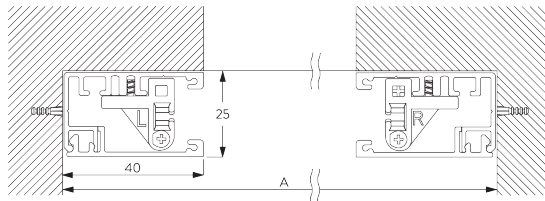

A: System width



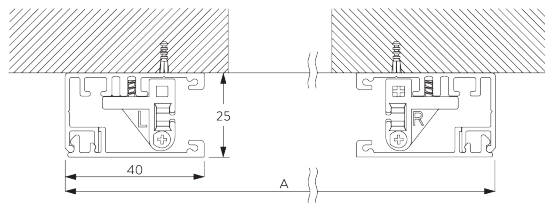







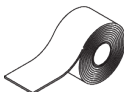

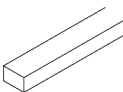
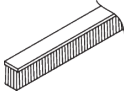

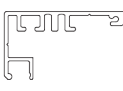
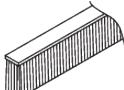

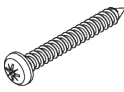
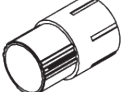
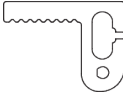
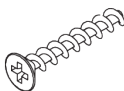
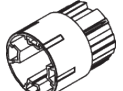
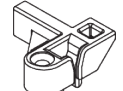
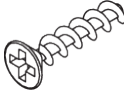
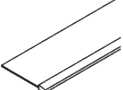
Face fitting

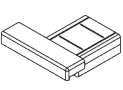
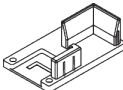
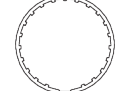
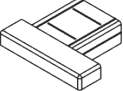
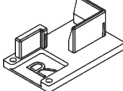
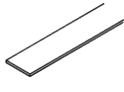
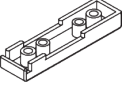

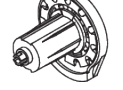
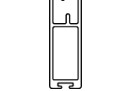
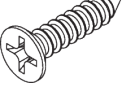
A: System width

# PARTS

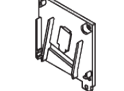
## A. STANDARD PARTS

	<b>SG 4226</b> Double tape 30 mm		<b>SG 11005</b> End cover right 73 mm		<b>SG 11060</b> Foam tape adhesive
	<b>SG 4508</b> Brush 5x7 mm		<b>SG 11010</b> Clip		<b>SG 11418</b> Side guide case
	<b>SG 4509</b> Brush 5x12 mm		<b>SG 11011</b> Clip		<b>SG 11419</b> Side guide cover
	<b>SG 6791</b> Pan head screw 3.9x32		<b>SG 11014</b> Tube adapter		<b>SG 11421</b> Zip profile
	<b>SG 6933</b> PT Countersunk screw KA25x16		<b>SG 11015</b> Tube adapter		<b>SG 11473</b> Zip guide left
	<b>SG 6936</b> PT Countersunk screw KA22x10		<b>SG 11025</b> Zip		<b>SG 11474</b> Zip guide right
	<b>SG 6942</b> Pan head screw KA30x8		<b>SG 11028</b> End cover left		<b>SG 11475</b> Side guide end cover left
	<b>SG 10532</b> Tube ø 43 mm		<b>SG 11029</b> End cover right		<b>SG 11476</b> Side guide end cover right
	<b>SG 10668</b> PVC strip 10 mm		<b>SG 11030</b> Cover		
	<b>SG 10731</b> Child safety retainer set		<b>SG 11031</b> Chain drive		
	<b>SG 10993</b> Bottom bar		<b>SG 11034</b> Countersunk head screw 3.5x16		
	<b>SG 10994</b> Box case 73 mm		<b>SG 11035</b> Countersunk head screw 2.2x9.5		
	<b>SG 10995</b> Box cover 73 mm		<b>SG 11040</b> Bead chain ø 4.5 mm		
	<b>SG 11004</b> End cover left 73 mm		<b>SG 11059</b> Pan head screw with flange M4x12		

## **B. OPTIONAL PARTS**

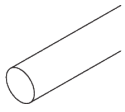

**SG 4951**

*Bottom weight ø 8 mm*



# SG 4730

---

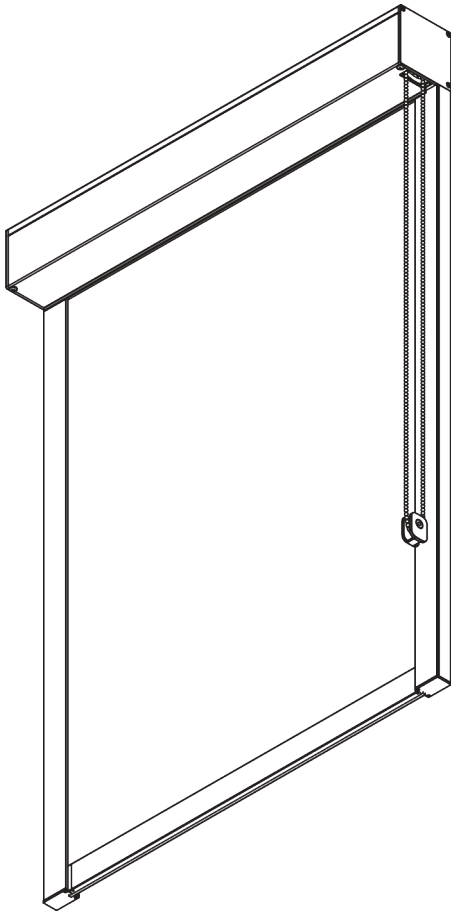
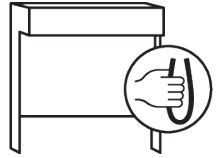

## PRODUCT INFORMATION

- **Operation:** chain
- **Range:** M
- **Fitting:** ceiling, wall, recess
- **Colours:** white RAL 9016 or black RAL 9005, special colours possible
- **Fabrics:** refer to Silent Gliss fabric collection

### **Features:**

- Zip technology
- Stainless steel bead chain
- 2-to-1 gear drive
- 40 mm side channel, pre-drilled fixing points

# SYSTEM SPECIFICATIONS

## A. SYSTEM DIMENSIONS

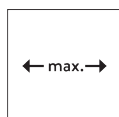

2.2 m

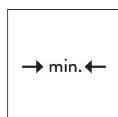

65 cm

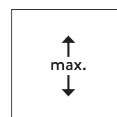

2.4 m

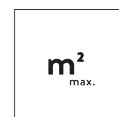

5.3 m<sup>2</sup>

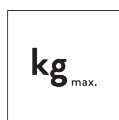

3.7 kg

## B. PROFILE

### Profile information

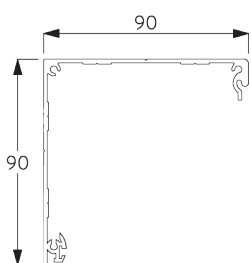

**SG 10996**

Box case 90 mm

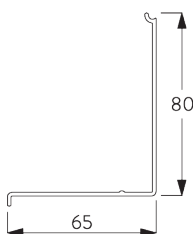

**SG 10997**

Box cover 90 mm

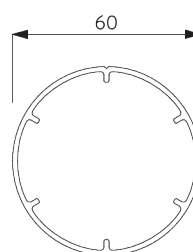

**SG 11037**

Tube ø 60 mm

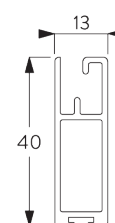

**SG 10993**

Bottom bar

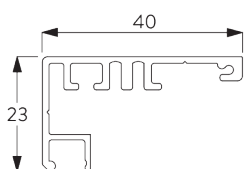

**SG 11418**

Side guide case

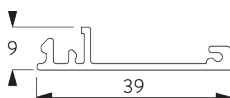

**SG 11419**

Side guide cover

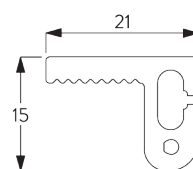

**SG 11421**

Zip profile

## C. HOW TO MEASURE

### Inside fitting

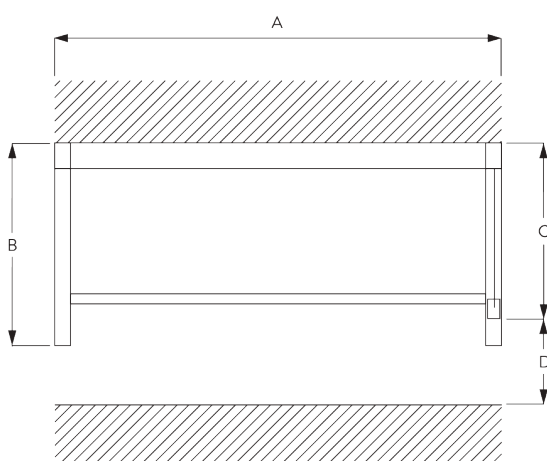

A: System width

B: System height

C: Chain height

D: Safety Retainer SG 10731 min. 150 cm above floor

## Face fitting

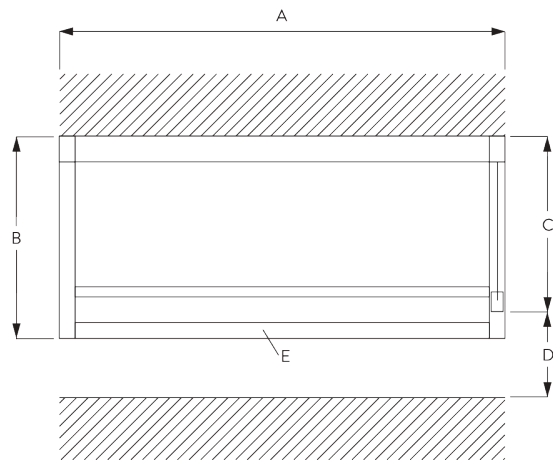

- A: System width
- B: System height
- C: Chain height
- D: Safety Retainer SG 10731 min. 150 cm above floor
- E: Optional: end profile (SG 11418 / SG 11419)

## D. SPECIFICATION

### TEXT

#### **EN**

Silent Gliss SG 4730 Chain Operated Dim-Out Roller Blind System. For blinds up to 2.2m wide by 2.4m drop, max 5.3 sq. m. Supplied complete and made to measure comprising aluminium headbox SG 10996-7 (90 mm), side profiles SG 11418 / SG 11419 and bottom hem bar SG 10993 in white or black powder coat finish as standard. Fabric edges retained by two component zip profile SG 11421. Operation by stainless steel bead chain with chain retainer SG 10731. Compliant to Child Safety Legislation EN 13120. Fabric to be chosen from the Silent Gliss fabric range, Price Group 1R / 2R / 3R.

#### **SV**

Silent Gliss SG 4730 mörkläggningsrullgardin med kulkedja. För system max 2,2 x 2,4 m, eller totalt max 5,3 m<sup>2</sup>. Levereras komplett i kundmått bestående av toppkassett i aluminium SG 10996-7 (90 mm), sidoprofiler SG 11418 / SG 11419 samt tyngdprofil SG 10993 i vit eller svart epoxy lack. Textilens kant försedd med zip profil SG 11421. Manövrering med rostfri kulkedja av stål samt väggfäste SG 10731. Textil från Silent Gliss textilprogram i prisgrupp 1-3.

#### **NO**

Silent Gliss SG 4730 Mørkleggende rullegardin med kulekjede. For system inntil 2,2 x 2,4 m, eller totalt max 5,3 m<sup>2</sup>. Levereras komplett måltilpasset. Består av toppkasse i aluminium SG 10996-7 (90 mm), sideprofiler SG 11418 / SG 11419 samt tyngdeprofil SG 10993 i hvit eller svart epoxy lakk. Sidene på tekstile er festet med zip profil SG 11421. Betjening med rustriitt kulekjede samt veggfeste SG 10731. Tekstiler fra Silent Gliss tekstilkolleksjon i prisgrupp 1-3.

# FITTING

## A. FITTING INFORMATION

For detailed fitting information, visit the Silent Gliss website.

**Inside fitting - fixing points**

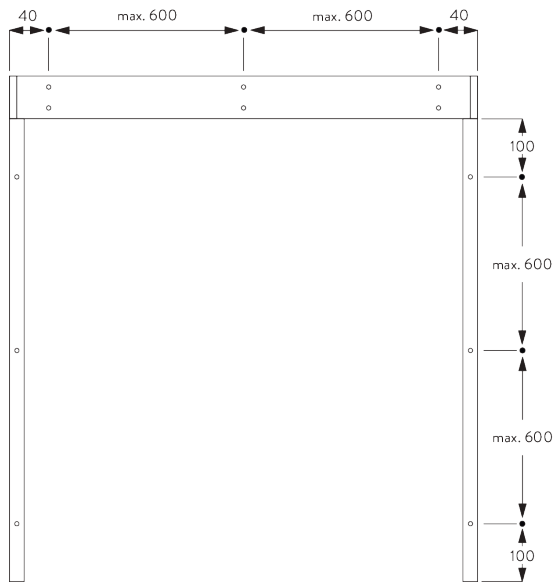

**Face fitting - fixing points**

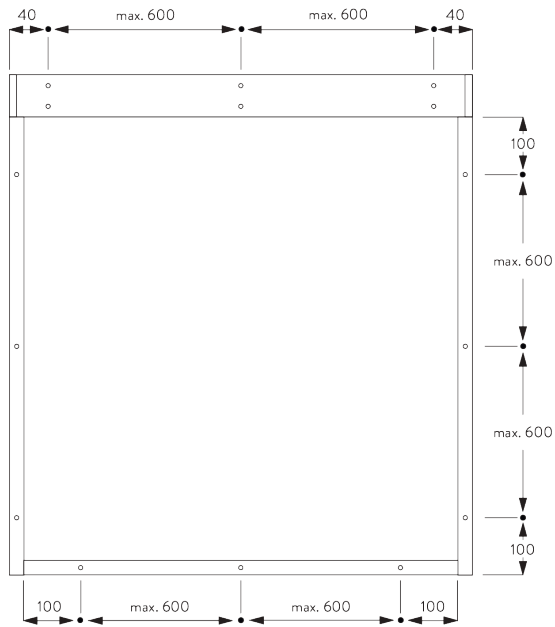

**B. CEILING FITTING**

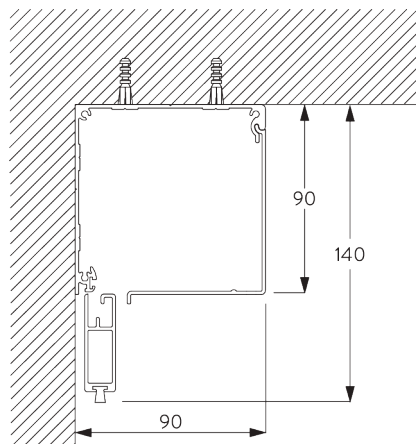



**C. WALL FITTING**

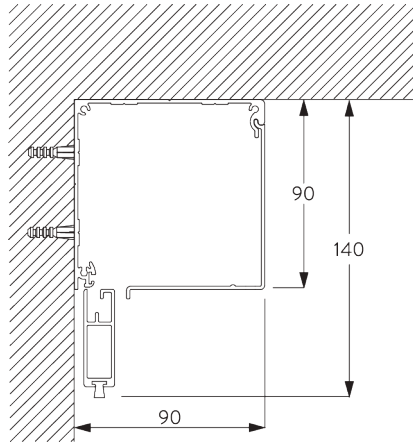

**D. RECESS FITTING**

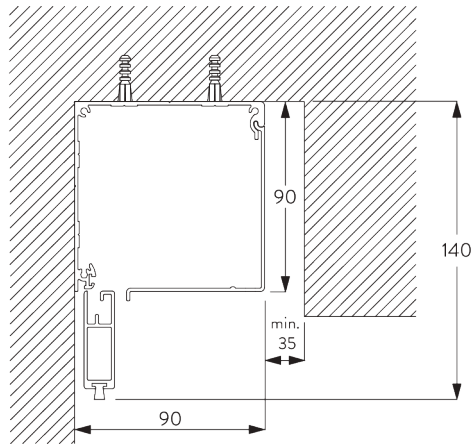

**E. SIDE PROFILES**  
**SG 11418 / SG 11419**

Inside fitting

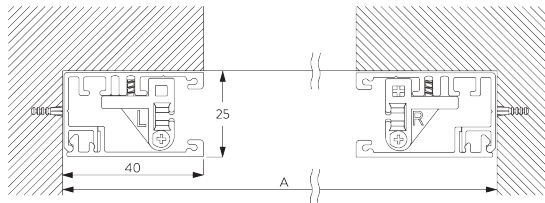

A: System width



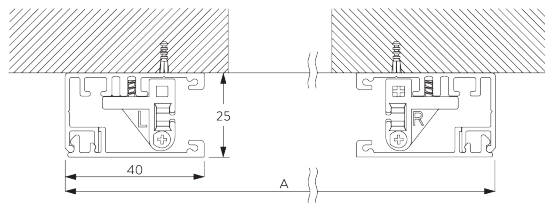







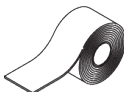

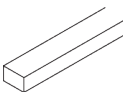
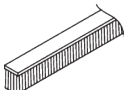

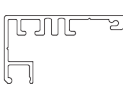
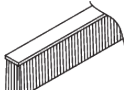





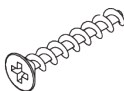
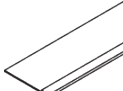
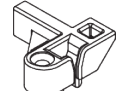

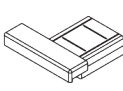

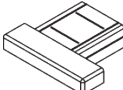
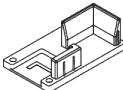
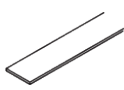
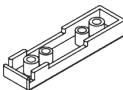
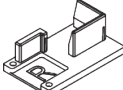
Face fitting

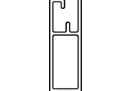

A: System width

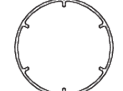
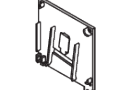
# PARTS

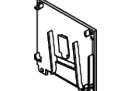
## A. STANDARD PARTS

	<b>SG 4226</b> Double tape 30 mm		<b>SG 11011</b> Clip		<b>SG 11060</b> Foam tape adhesive
	<b>SG 4508</b> Brush 5x7 mm		<b>SG 11012</b> Clip		<b>SG 11418</b> Side guide case
	<b>SG 4509</b> Brush 5x12 mm		<b>SG 11017</b> Tube adapter		<b>SG 11419</b> Side guide cover
	<b>SG 6791</b> Pan head screw 3.9x32		<b>SG 11018</b> Tube adapter		<b>SG 11421</b> Zip profile
	<b>SG 6933</b> PT Countersunk screw KA25x16		<b>SG 11025</b> Zip		<b>SG 11473</b> Zip guide left
	<b>SG 6936</b> PT Countersunk screw KA22x10		<b>SG 11028</b> End cover left		<b>SG 11474</b> Zip guide right
	<b>SG 6942</b> Pan head screw KA30x8		<b>SG 11029</b> End cover right		<b>SG 11475</b> Side guide end cover left
	<b>SG 10668</b> PVC strip 10 mm		<b>SG 11030</b> Cover		<b>SG 11476</b> Side guide end cover right
	<b>SG 10731</b> Child safety retainer set		<b>SG 11032</b> Chain drive		
	<b>SG 10993</b> Bottom bar		<b>SG 11034</b> Countersunk head screw 3.5x16		
	<b>SG 10996</b> Box case 90 mm		<b>SG 11035</b> Countersunk head screw 2.2x9.5		
	<b>SG 10997</b> Box cover 90 mm		<b>SG 11037</b> Tube ø 60 mm		
	<b>SG 11006</b> End cover left 90 mm		<b>SG 11040</b> Bead chain ø 4.5 mm		
	<b>SG 11007</b> End cover right 90 mm		<b>SG 11059</b> Pan head screw with flange M4x12		

## **B. OPTIONAL PARTS**

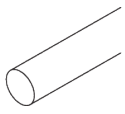

**SG 4951**

*Bottom weight ø 8 mm*



**SG 11050**

*Spring left*



**SG 11051**

*Spring right*



# SG 4740

---

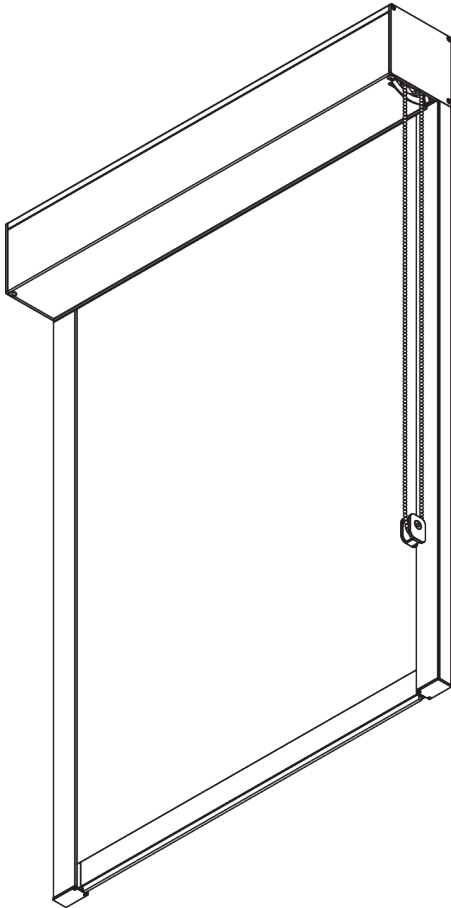
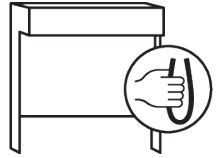

## PRODUCT INFORMATION

- **Operation:** chain
- **Range:** L
- **Fitting:** ceiling, wall, recess
- **Colours:** white RAL 9016 or black RAL 9005, special colours possible
- **Fabrics:** refer to Silent Gliss fabric collection

### **Features:**

- Zip technology
- Stainless steel bead chain
- 2-to-1 gear drive
- 40 mm side channel, pre-drilled fixing points

# SYSTEM SPECIFICATIONS

## A. SYSTEM DIMENSIONS

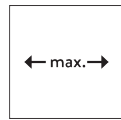

3 m

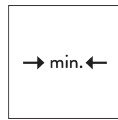

65 cm

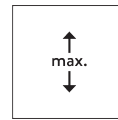

3 m



9 m<sup>2</sup>



6 kg

## B. PROFILE

### Profile information

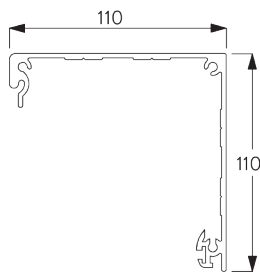

**SG 10998**

Box case 110 mm

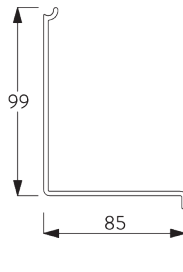

**SG 10999**

Box cover 110 mm

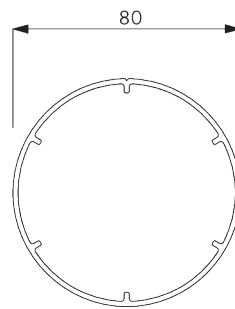

**SG 11003**

Tube ø 80 mm

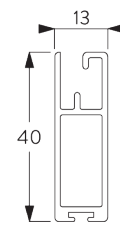

**SG 10993**

Bottom bar

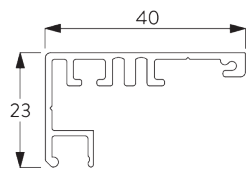

**SG 11418**

Side guide case



**SG 11419**

Side guide cover

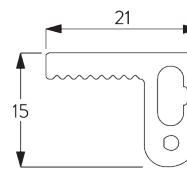

**SG 11421**

Zip profile

## C. HOW TO MEASURE

### Inside fitting

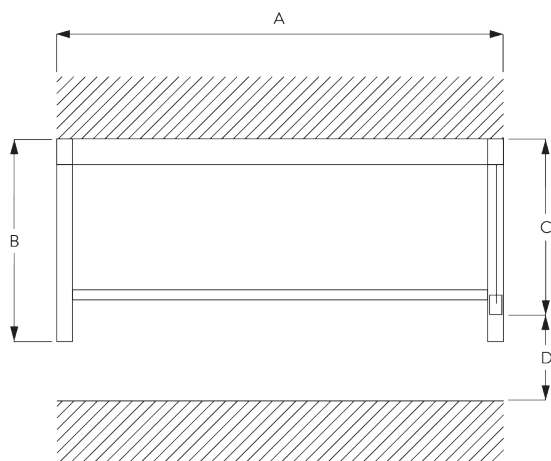

- A: System width
- B: System height
- C: Chain height
- D: Safety Retainer SG 10731 min. 150 cm above floor

### Face fitting

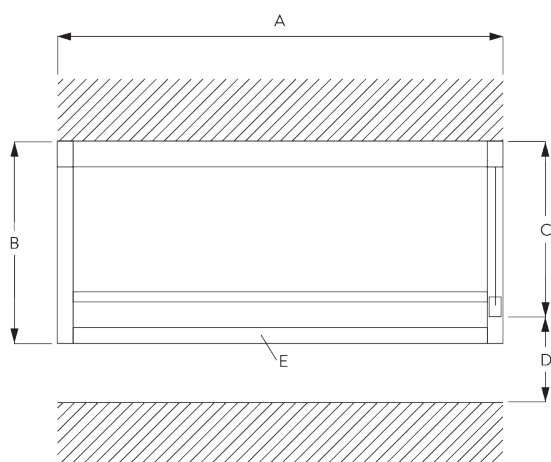

- A: System width
- B: System height
- C: Chain height
- D: Safety Retainer SG 10731 min. 150 cm above floor
- E: Optional: end profile (SG 11418 / SG 11419)

## D. SPECIFICATION TEXT

### EN

Silent Gliss SG 4740 Chain Operated Dim-Out Roller Blind System. For blinds up to 3m wide by 3m drop, max 9.0sq. m. Supplied complete and made to measure comprising aluminium headbox SG 10998-9 (110 mm), side profiles SG 11418 / SG 11419 and bottom hem bar SG 10993 in white or black powder coat finish as standard. Fabric edges retained by two component zip profile SG 11421. Operation by stainless steel bead chain with chain retainer SG 10731. Compliant to Child Safety Legislation EN 13120. Fabric to be chosen from the Silent Gliss fabric range, Price Group 1R / 2R / 3R.

### SV

Silent Gliss SG 4740 mörkläggningsrullgardin med kulkedja. För system max 3 x 3 m, eller totalt max 9 m<sup>2</sup>. Levereras komplett i kundmått bestående av toppkassett i aluminium SG 10998-9 (110 mm), sidoprofiler SG 11418 / SG 11419 samt tyngdprofil SG 10993 i vit eller svart epoxy lack. Textilens kant försedd med zip profil SG 11421. Manövrering med rostfri kulkedja av stål samt väggfäste SG 10731. Textil från Silent Gliss textilprogram i prisgrupp 1-3.

### NO

Silent Gliss SG 4740 Mørkleggende rullegardin med kulekjede. For system inntil 3 x 3 m, eller totalt max 9 m<sup>2</sup>. Levereras komplett måltilpasset. Består av toppkasse i aluminium SG 10998-9 (110 mm), sideprofiler SG 11418 / SG 11419 samt tyngdeprofil SG 10993 i hvit eller svart epoxy lakk. Sidene på tekstilet er festet med zip profil SG 11421. Betjening med rustritt kulekjede samt veggfeste SG 10731. Tekstiler fra Silent Gliss tekstilkolleksjon i prisgrupp 1-3.

# FITTING

## A. FITTING INFORMATION

For detailed fitting information, visit the [Silent Gliss website](#).

### Inside fitting - fixing points

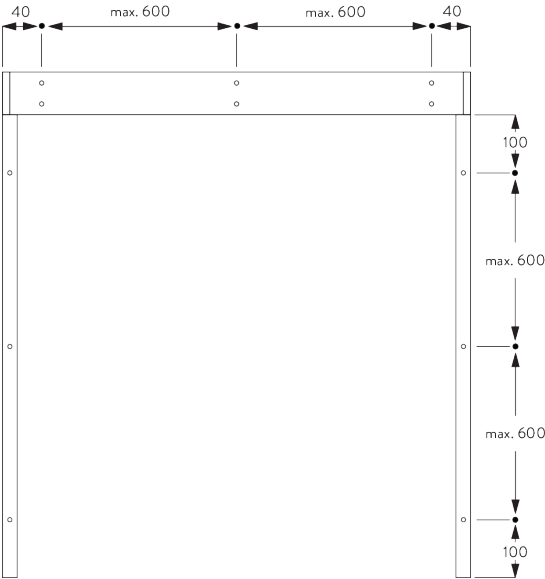

### Face fitting - fixing points

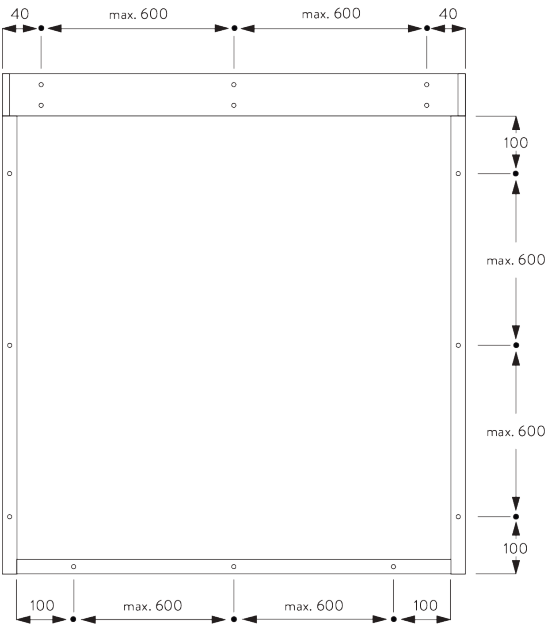



**B. CEILING FITTING**

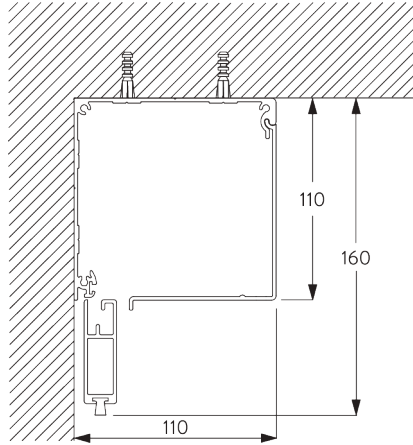

**C. WALL FITTING**

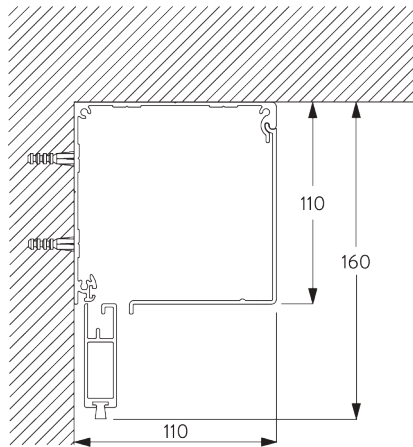

**D. RECESS FITTING**

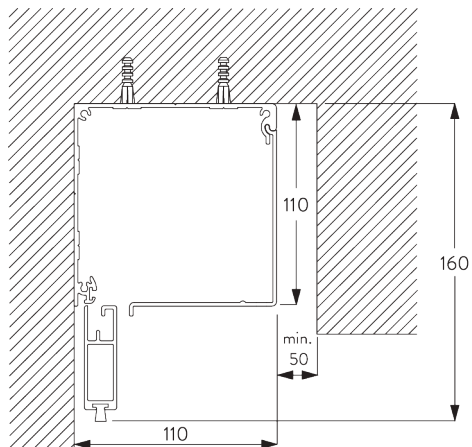

**E. SIDE PROFILES**  
**SG 11418 / SG 11419**

Inside fitting

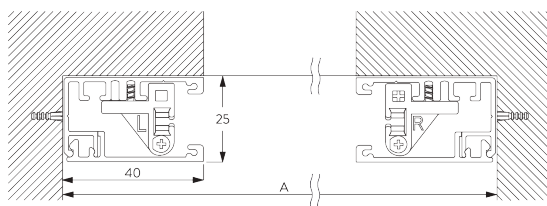

A: System width



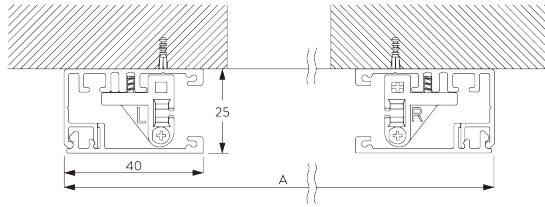









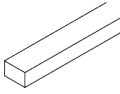
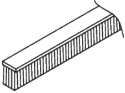

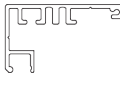
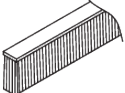

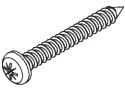

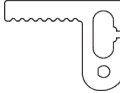
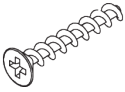
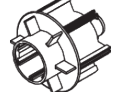
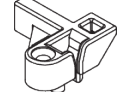
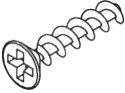
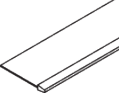
## Face fitting

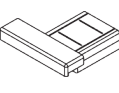
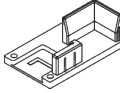

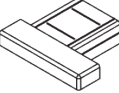
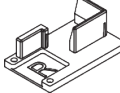
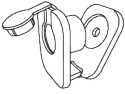
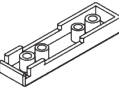
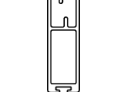
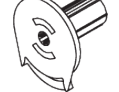
A: System width

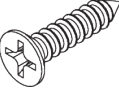
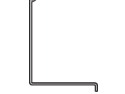
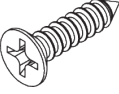
# PARTS

## A. STANDARD PARTS

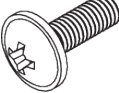
	<b>SG 4226</b> Double tape 30 mm		<b>SG 11009</b> End cover right 110 mm		<b>SG 11060</b> Foam tape adhesive
	<b>SG 4508</b> Brush 5x7 mm		<b>SG 11011</b> Clip		<b>SG 11418</b> Side guide case
	<b>SG 4509</b> Brush 5x12 mm		<b>SG 11012</b> Clip		<b>SG 11419</b> Side guide cover
	<b>SG 6791</b> Pan head screw 3.9x32		<b>SG 11020</b> Tube adapter		<b>SG 11421</b> Zip profile
	<b>SG 6933</b> PT Countersunk screw KA25x16		<b>SG 11021</b> Tube adapter		<b>SG 11473</b> Zip guide left
	<b>SG 6936</b> PT Countersunk screw KA22x10		<b>SG 11025</b> Zip		<b>SG 11474</b> Zip guide right
	<b>SG 6942</b> Pan head screw KA30x8		<b>SG 11028</b> End cover left		<b>SG 11475</b> Side guide end cover left
	<b>SG 10668</b> PVC strip 10 mm		<b>SG 11029</b> End cover right		<b>SG 11476</b> Side guide end cover right
	<b>SG 10731</b> Child safety retainer set		<b>SG 11030</b> Cover		
	<b>SG 10993</b> Bottom bar		<b>SG 11033</b> Chain drive		
	<b>SG 10998</b> Box case 110 mm		<b>SG 11034</b> Countersunk head screw 3.5x16		
	<b>SG 10999</b> Box cover 110 mm		<b>SG 11035</b> Countersunk head screw 2.2x9.5		
	<b>SG 11003</b> Tube ø 80 mm		<b>SG 11040</b> Bead chain ø 4.5 mm		
	<b>SG 11008</b> End cover left 110 mm		<b>SG 11059</b> Pan head screw with flange M4x12		

## B. OPTIONAL PARTS

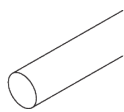

**SG 4951**

*Bottom weight ø 8 mm*



**SG 11052**

*Spring left*



**SG 11053**

*Spring right*

# SG 4760

---

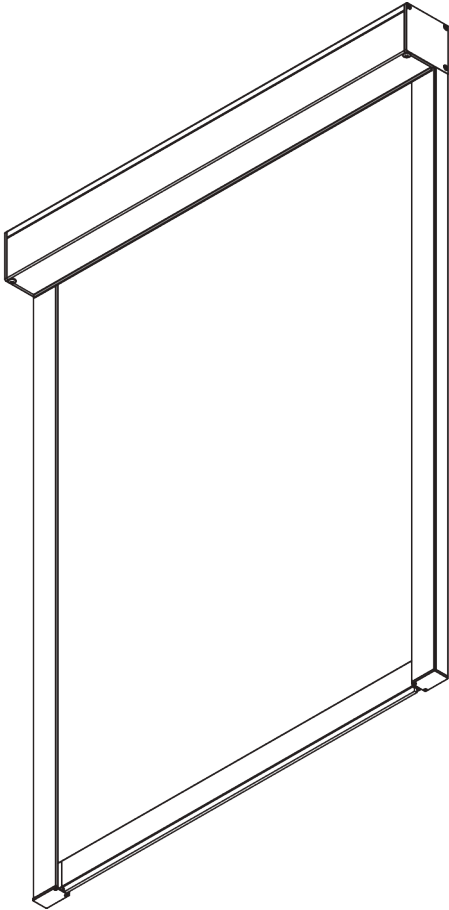
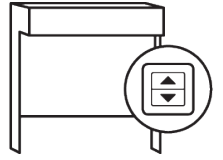

## PRODUCT INFORMATION

- **Operation:** motorised
- **Range:** S
- **Fitting:** ceiling, wall, recess
- **Colours:** white RAL 9016 or black RAL 9005, special colours possible
- **Fabrics:** refer to Silent Gliss fabric collection

### **Features:**

- Zip technology
- Quiet and fast motors
- Soft stop
- Various control options
- 40 mm side channel, pre-drilled fixing points

# SYSTEM SPECIFICATIONS

## A. SYSTEM DIMENSIONS

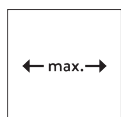

1.6 m

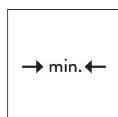

65 cm

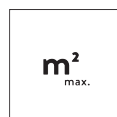

1.6 m

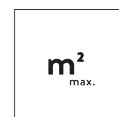

2.5 m<sup>2</sup>



2 kg

## B. PROFILE

### Profile information

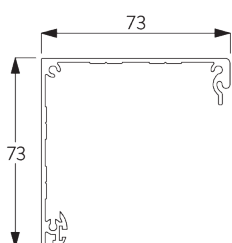

**SG 10994**  
Box case 73 mm

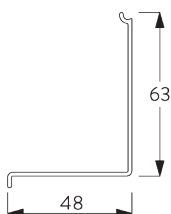

**SG 10995**  
Box cover 73 mm

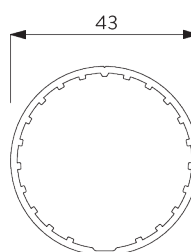

**SG 10532**  
Tube ø 43 mm

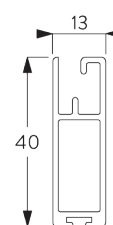

**SG 10993**  
Bottom bar

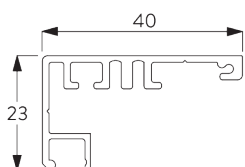

**SG 11418**  
Side guide case

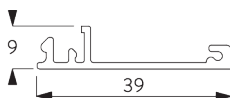

**SG 11419**  
Side guide cover

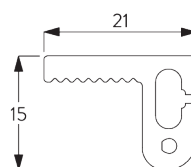

**SG 11421**  
Zip profile

## C. HOW TO MEASURE

### Inside fitting

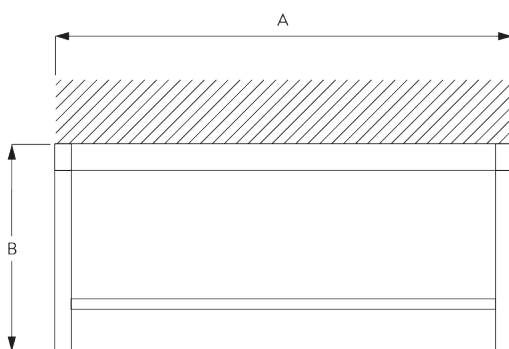

A: System width  
B: System height



## Face fitting

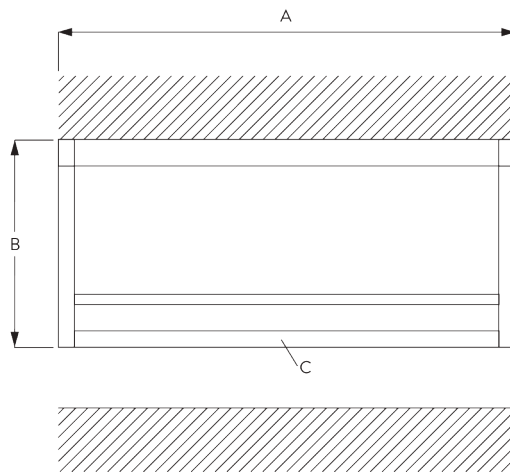

- A: System width
- B: System height
- C: Optional: end profile (SG 11418 / SG 11419)

## D. SPECIFICATION

### TEXT

#### EN

Silent Gliss SG 4760 Electrically Operated Dim-Out Roller Blind System with SG Series 20 motors. For blinds up to 1.6m wide by 1.6m drop, max 2.5sq.m. Supplied complete and made to measure comprising aluminium headbox SG 10994-5 (73 mm), side profiles SG 11418 / SG 11419 and bottom hem bar SG 10993 in white or black powder coat finish as standard.

Fabric edges retained by two component zip profile SG 11421. Operation by mains switch (not supplied) or mains switching by third party control system or SG 0450 remote control system (wireless controls at extra cost). All wiring to be strictly in accordance with Silent Gliss wiring diagrams. Fabric to be chosen from the Silent Gliss fabric range, Price Group 1R / 2R / 3R.

#### SV

Silent Gliss SG 4760 mörkläggningsrullgardin med motor serie 20. För system max 1,6 x 1,6 m, eller totalt max 2,5 m<sup>2</sup>. Levereras komplett i kundmått bestående av toppkassett i aluminium SG 10994-5 (73 mm), sidoprofiler SG 11418 / SG 11419 samt tyngdprofil SG 10993 i vit eller svart epoxy lack. Textilens kant försedd med zip profil SG 11421. Integrerad 230V motor SG 10320 / (SG 10321 radiomottagare) vänster / höger sida. Styrning via väggkontakt (ej inkluderad), via fjärrkontroll eller via externt styrsystem. All elinstallation skall följa Silent Gliss kopplingschema. Textil från Silent Gliss textilprogram i prisgrupp 1-3.

#### NO

Silent Gliss SG 4760 Mørkleggende rullegardin med motor serie 20. For system inntil 1,6 x 1,6 m, eller totalt max 2,5 m<sup>2</sup>. Levereras komplett måltilpasset. Består av toppkasse i aluminium SG 10994-5 (73 mm), sideprofiler SG 11418 / SG 11419 samt tyngdeprofil SG 10993 i hvit eller svart epoxy lakk. Sidene på tekstile er festet med zip profil SG 11421. Integrert 230V motor SG10320 / (SG 10321 radiomottaker) venstre eller høyre side. Betjenes med veggbryter (ikke inkludert), fjernkontroll eller via eksternt styrsystem. Ved alle elektriske installasjoner skal Silent Gliss koblingskjema benyttes. Tekstiler fra Silent Gliss tekstilkolleksjon i prisgrupp 1-3.

# FITTING

## A. FITTING INFORMATION

For detailed fitting information, visit the Silent Gliss website.

**Inside fitting - fixing points**

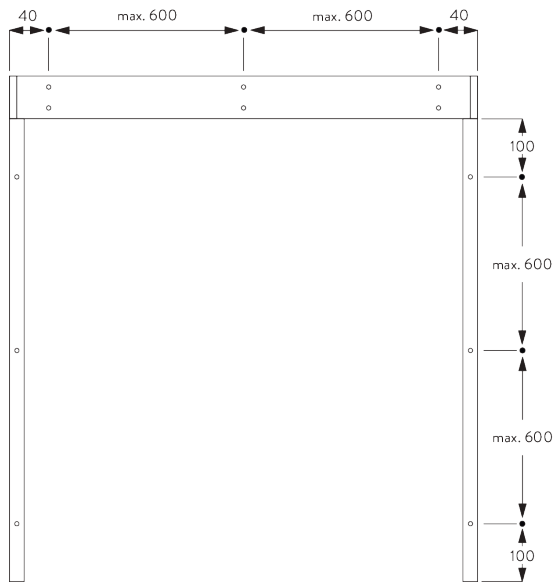

**Face fitting - fixing points**

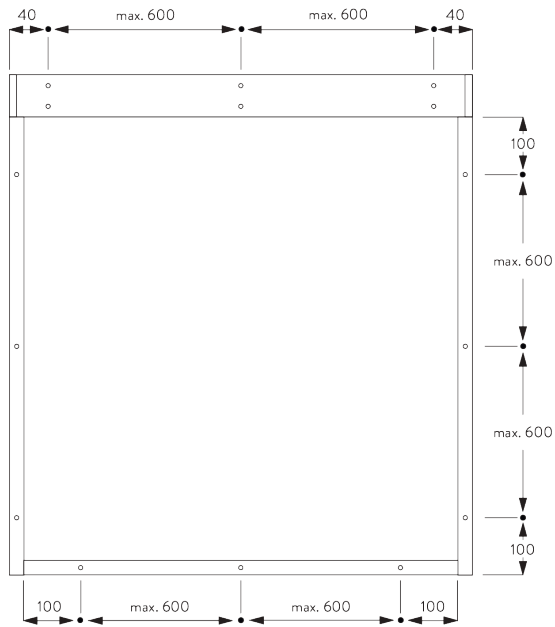

**B. CEILING FITTING**

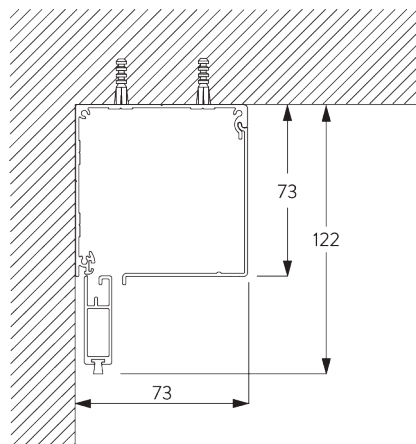



### C. WALL FITTING

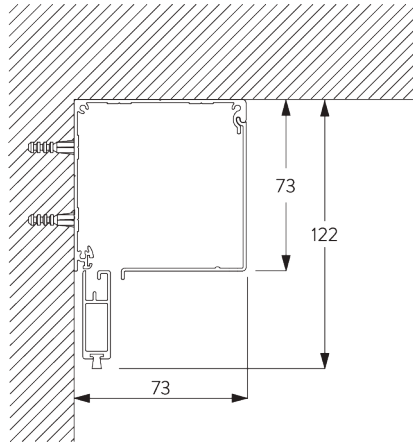

### D. RECESS FITTING

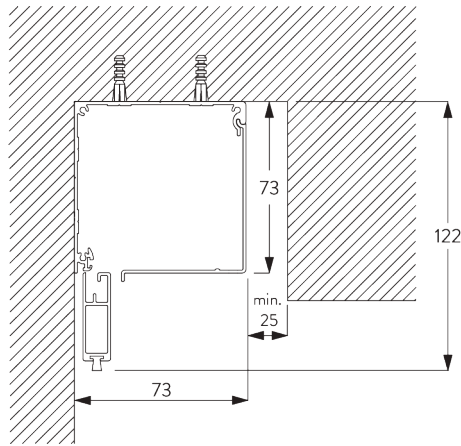

### E. SIDE PROFILES SG 11418 / SG 11419

Inside fitting

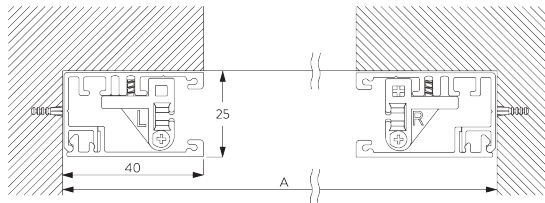

A: System width

Face fitting

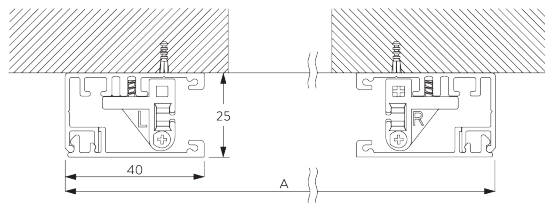

A: System width

# MOTORS & CONTROLS

## A. MOTOR FEATURES

Motors	50-Series	20-Series	20-Series	10-Series K	5-Series
	SG 11251	SG 10523	SG 10522	SG 10514	SG 10715

### Motor Features

Soft stop	•	•	•		
Electronic end-stop	•	•	•		
Electronic revolution counter (unlimited revolution)	•	•	•		
Mechanical end-stop				•	•
Mechanical revolution counter (limited revolution)				•	•
Two intermediate positions possible		•			
Bottom bar alignment	•				
Noiseless stop		•	•	•	
Parallel wiring possible without additional relays		•	•		
Disconnectable motor cable	•	•	•		
IP class	IP 30	IP 44	IP 44	IP 44	IP 44

### Control Features

Mains power control		•	•	•	•
SG Control L (built-in receiver)		•			
Smart by Silent Gliss	•				
Suitable for most major home automation systems (with suitable interface)		•	•	•	•

## B. MOTOR SPECIFICATIONS

Motors	Min. system width	Voltage	Current	Frequency	Speed	Frequency receiver
<b>50-Series (Smart by Silent Gliss)</b>						
SG 11251	65 cm	24 V DC	1.5 A	-	32 rpm	-
<b>20-Series</b>						
SG 10522 (standard)	65 cm	230 V AC	0.55 A	50 Hz	30 rpm	-
SG 10523	65 cm	230 V AC	0.55 A	50 Hz	30 rpm	868/915 MHz
<b>10-Series K</b>						
SG 10514	65 cm	230 V AC	0.52 A	50 Hz	30 rpm	-
<b>5-Series</b>						
SG 10715	65 cm	230 V AC	0.485 A	50-60 Hz	28 rpm	-

## C. OPERATING METHODS

See catalogue "controls" for details.

### Wall Switch



System can be operated by fixed wall switch.

**SG Control L**



*Various radio hand-held and wall transmitters available.*



*Silent Gliss Move App.*

**Smart by Silent Gliss**



*Open designed two-way communication system which allows to flawlessly integrate products with most major building management systems.*









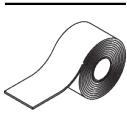

**D. WIRING**  
**DIAGRAMS**

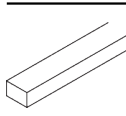
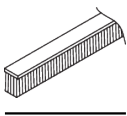
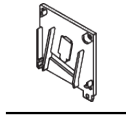
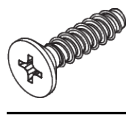
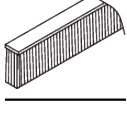
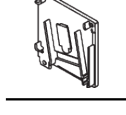
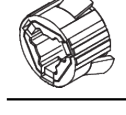
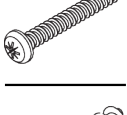
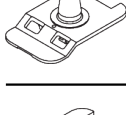
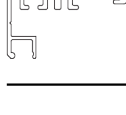
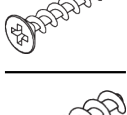
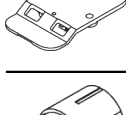
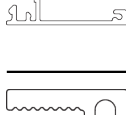
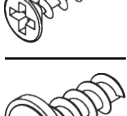
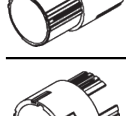
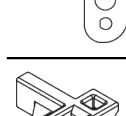
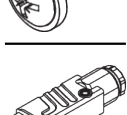

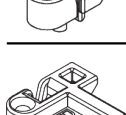
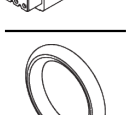
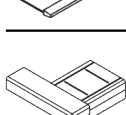
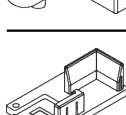
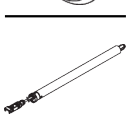
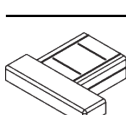
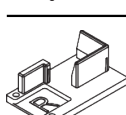
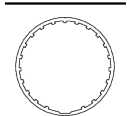
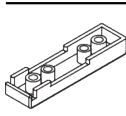

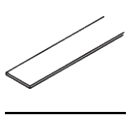
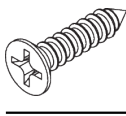
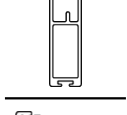
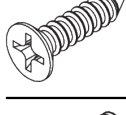

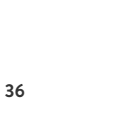





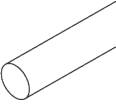
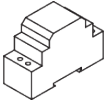
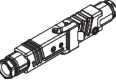
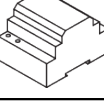
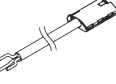
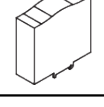

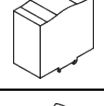

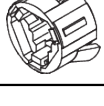
*Refer to Silent Gliss website.*

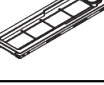
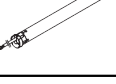
# PARTS

## A. STANDARD PARTS

	<b>SG 4226</b> Double tape 30 mm		<b>SG 10995</b> Box cover 73 mm		<b>SG 11060</b> Foam tape adhesive
	<b>SG 4508</b> Brush 5x7 mm		<b>SG 11004</b> End cover left 73 mm		<b>SG 11324</b> PT Screw Countersunk KA35x14
	<b>SG 4509</b> Brush 5x12 mm		<b>SG 11005</b> End cover right 73 mm		<b>SG 11354</b> Motor drive 10/20-Series
	<b>SG 6791</b> Pan head screw 3.9x32		<b>SG 11011</b> Clip		<b>SG 11418</b> Side guide case
	<b>SG 6933</b> PT Countersunk screw KA25x16		<b>SG 11013</b> Clip		<b>SG 11419</b> Side guide cover
	<b>SG 6936</b> PT Countersunk screw KA22x10		<b>SG 11014</b> Tube adapter		<b>SG 11421</b> Zip profile
	<b>SG 6942</b> Pan head screw KA30x8		<b>SG 11016</b> Tube adapter		<b>SG 11473</b> Zip guide left
	<b>SG 9917</b> Hirschmann portable socket-outlet STAK 3 N		<b>SG 11025</b> Zip		<b>SG 11474</b> Zip guide right
	<b>SG 10284</b> O-Ring		<b>SG 11028</b> End cover left		<b>SG 11475</b> Side guide end cover left
	<b>SG 10522</b> Motor 230V AC, 20-Series S 3/30		<b>SG 11029</b> End cover right		<b>SG 11476</b> Side guide end cover right
	<b>SG 10532</b> Tube ø 43 mm		<b>SG 11030</b> Cover		
	<b>SG 10668</b> PVC strip 10 mm		<b>SG 11034</b> Countersunk head screw 3.5x16		
	<b>SG 10993</b> Bottom bar		<b>SG 11035</b> Countersunk head screw 2.2x9.5		
	<b>SG 10994</b> Box case 73 mm		<b>SG 11059</b> Pan head screw with flange M4x12		

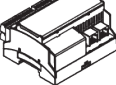
## B. OPTIONAL PARTS

	<b>SG 4951</b> Bottom weight ø 8 mm		<b>SG 11263</b> Power supply 24V DC, 2 Ampere DIN Rail
	<b>SG 9916</b> Hirschmann plug set		<b>SG 11264</b> Power supply 24V DC, 3.8 Ampere DIN Rail
	<b>SG 10293</b> Cable 230V AC, 2/3/5/10 m		<b>SG 11265</b> Power supply 24V DC, 5 Ampere DIN Rail
	<b>SG 10300</b> Radio hand held 1 channel		<b>SG 11266</b> Power supply 24V DC, 10 Ampere DIN Rail
	<b>SG 10302</b> Radio hand held 5+1 channel		<b>SG 11356</b> Motor drive 40/50-Series
	<b>SG 10303</b> Radio hand held 10+2+1 channel		<b>SG 11460</b> Cover for Hirschmann plug
	<b>SG 10514</b> Tubular motor 230V AC, 10 Series S 3/30 K		<b>SG 11480</b> Radio wall transmitter 1 channel
	<b>SG 10523</b> Motor 230V AC, 20-Series S 3/30, radio receiver		<b>SG 11490</b> Radio wall transmitter 5+1 channel
	<b>SG 10715</b> Tubular motor 230V AC, 5 Series S 6/28		
	<b>SG 10804</b> Radio hand held 15+5+1 channel		
	<b>SG 11251</b> Tubular motor 24V DC, 50-Series S 3/32		
	<b>SG 11260</b> Gateway Cedia		
	<b>SG 11261</b> Gateway KNX		
	<b>SG 11262</b> Expansion unit		



# SG 4770

---

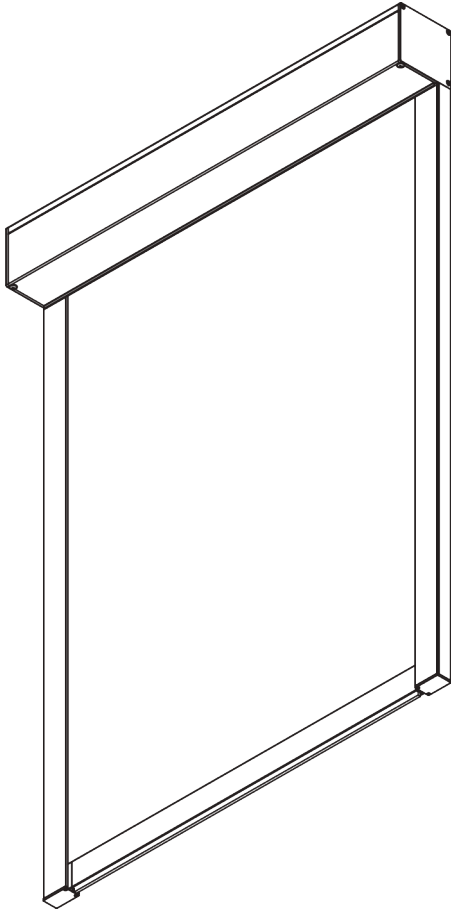
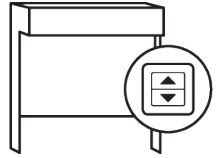

## PRODUCT INFORMATION

- **Operation:** motorised
- **Range:** M
- **Fitting:** ceiling, wall, recess
- **Colours:** white RAL 9016 or black RAL 9005, special colours possible
- **Fabrics:** refer to Silent Gliss fabric collection

### **Features:**

- Zip technology
- Quiet and fast motors
- Soft stop
- Various control options
- 40 mm side channel, pre-drilled fixing points

# SYSTEM SPECIFICATIONS

## A. SYSTEM DIMENSIONS

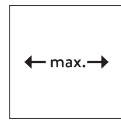

2.2 m

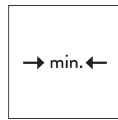

65 cm

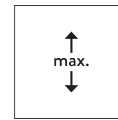

2.4 m



5.3 m<sup>2</sup>



3.7 kg

## B. PROFILE

### Profile information

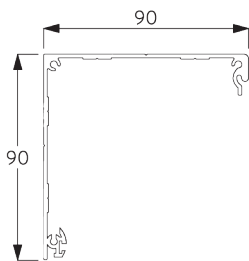

**SG 10996**

Box case 90 mm

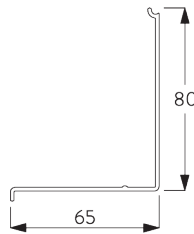

**SG 10997**

Box cover 90 mm

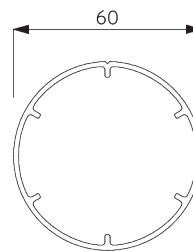

**SG 11037**

Tube ø 60 mm

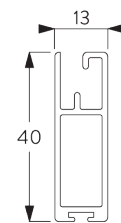

**SG 10993**

Bottom bar

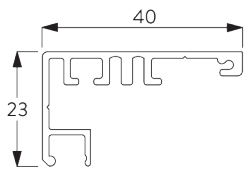

**SG 11418**

Side guide case

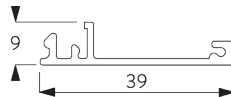

**SG 11419**

Side guide cover

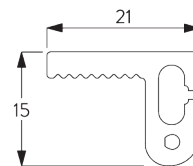

**SG 11421**

Zip profile

## C. HOW TO MEASURE

### Inside fitting

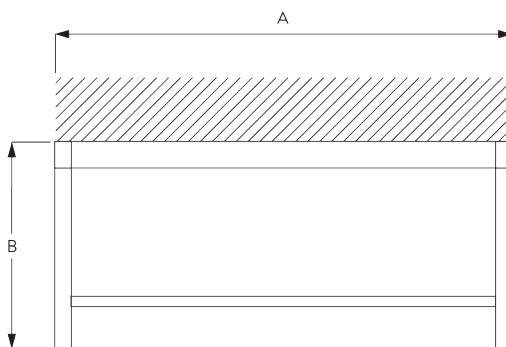

A: System width  
B: System height





## Face fitting

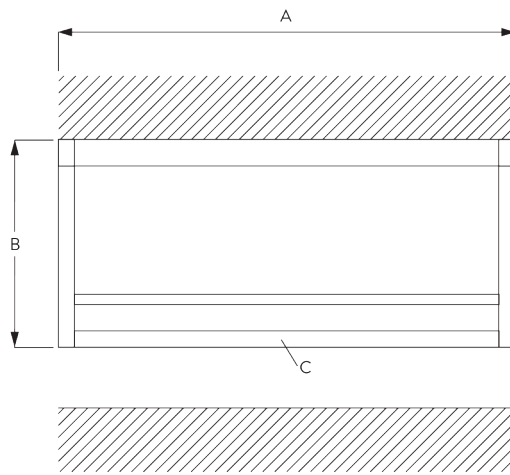

- A: System width
- B: System height
- C: Optional: end profile (SG 11418 / SG 11419)

## D. SPECIFICATION

### TEXT

#### **EN**

Silent Gliss SG 4770 Electrically Operated Dim-Out Roller Blind System with SG Series 20 motors. For blinds up to 2.2 m wide by 2.4 m drop, max 5.3sq. m. Supplied complete and made to measure comprising aluminium headbox SG 10996-7 (90 mm), side profiles SG 11418 / SG 11419 and bottom hem bar SG 10993 in white or black powder coat finish as standard. Fabric edges retained by two component zip profile SG 11421. Operation by mains switch (not supplied) or mains switching by third party control system or remote control system. All wiring to be strictly in accordance with Silent Gliss wiring diagrams. Fabric to be chosen from the Silent Gliss fabric range, Price Group 1R / 2R / 3R.

#### **SV**

Silent Gliss SG 4770 mörkläggningsrullgardin med motor serie 20. För system max 2,2 x 2,4 m, eller totalt max 5,3 m<sup>2</sup>. Levereras komplett i kundmått bestående av toppkassett i aluminium SG 10996-7 (90 mm), sidoprofiler SG 11418/ SG 11419 samt tyngdprofil SG 10993 i vit eller svart epoxy lack. Textilens kant försedd med zip profil SG 11421. Integrerad 230V motor SG 10522 / (SG 10523 radiomottagare) vänster / höger sida. Styrning via väggkontakt(ej inkluderad), via fjärrkontroll eller via externt styrsystem. All elinstallation skall följa Silent Gliss kopplingsschema. Textil från Silent Gliss textilprogram i prisgrupp 1-3.

#### **NO**

Silent Gliss SG 4770 Mørkleggende rullegardin med motor serie 20. For system inntil 2,2 x 2,2 m, eller totalt max 5,3 m<sup>2</sup>. Levereras komplett måltilpasset. Består av toppkasse i aluminium SG 10996-7 (90 mm), sideprofiler SG 11418/ SG 11419 samt tyngdeprofil SG 10993 i hvit eller svart epoxy lakk. Sidene på tekstile er festet med zip profil SG 11421. Integrert 230V motor SG 10522 / (SG 10523 radiomottaker) venstre eller høyre side. Betjenes med veggbryter (ikke inkludert), fjernkontroll eller via eksternt styrsystem. Ved alle elektriske installasjoner skal Silent Gliss koblingskjema benyttes. Tekstiler fra Silent Gliss tekstilkolleksjon i prisgrupp 1-3.

# FITTING

## A. FITTING INFORMATION

For detailed fitting information, visit the Silent Gliss website.

**Inside fitting - fixing points**

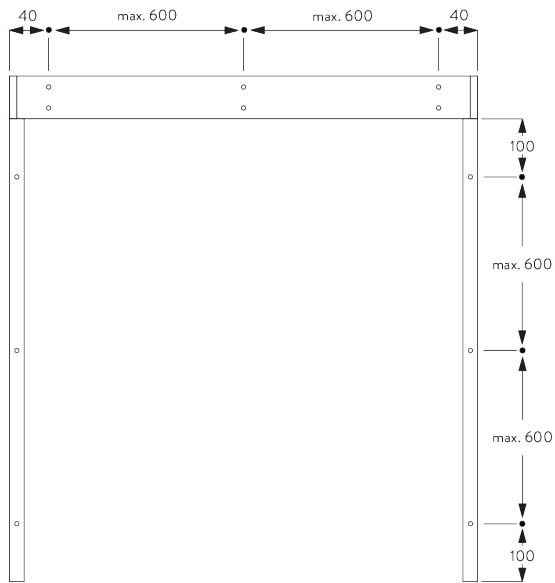

**Face fitting - fixing points**

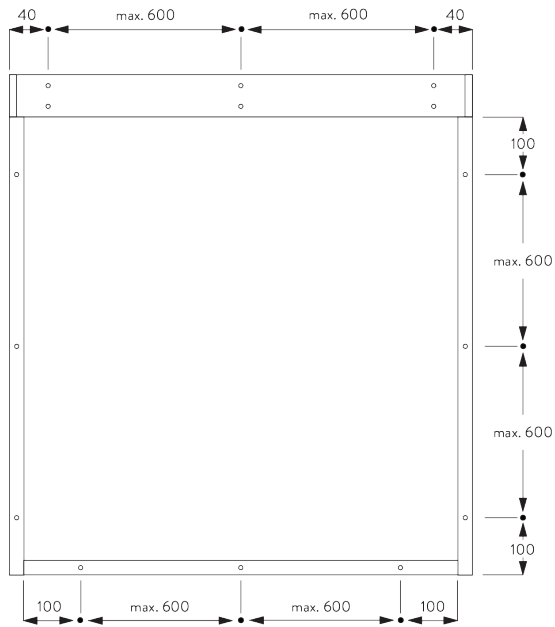

**B. CEILING FITTING**

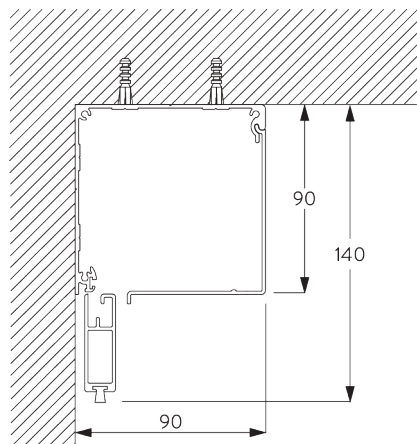

**C. WALL FITTING**

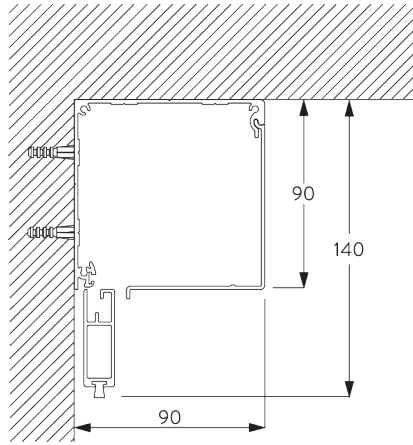

**D. RECESS FITTING**

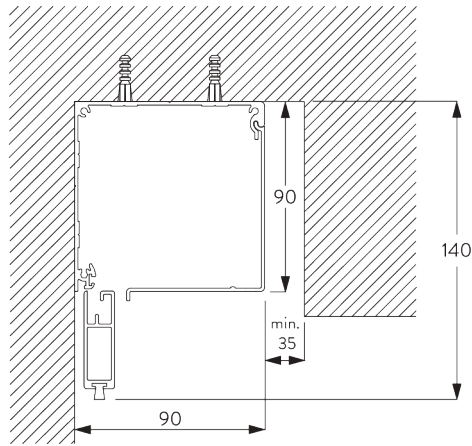

**E. SIDE PROFILES**  
**SG 11418 / SG 11419**

Inside fitting

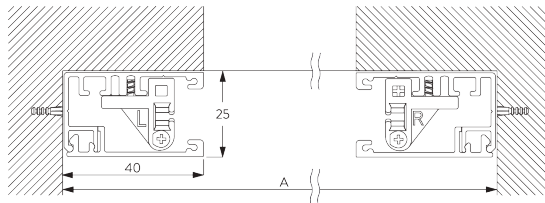

A: System width

Face fitting

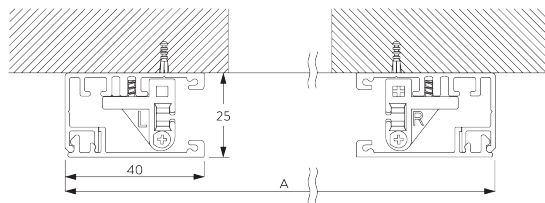

A: System width

# MOTORS & CONTROLS

## A. MOTOR FEATURES

Motors	50-Series	20-Series	20-Series	10-Series K	5-Series
	SG 11251	SG 10523	SG 10522	SG 10514	SG 10715

### Motor Features

Soft stop	•	•	•		
Electronic end-stop	•	•	•		
Electronic revolution counter (unlimited revolution)	•	•	•		
Mechanical end-stop				•	•
Mechanical revolution counter (limited revolution)				•	•
Two intermediate positions possible		•			
Bottom bar alignment	•				
Noiseless stop		•	•	•	
Parallel wiring possible without additional relays		•	•		
Disconnectable motor cable	•	•	•		
IP class	IP 30	IP 44	IP 44	IP 44	IP 44

### Control Features

Mains power control		•	•	•	•
SG Control L (built-in receiver)		•			
Smart by Silent Gliss	•				
Suitable for most major home automation systems (with suitable interface)		•	•	•	•

## B. MOTOR SPECIFICATIONS

Motors	Min. system width	Voltage	Current	Frequency	Speed	Frequency receiver
<b>50-Series (Smart by Silent Gliss)</b>						
SG 11251	65 cm	24 V DC	1.5 A	-	32 rpm	-
<b>20-Series</b>						
SG 10522 (standard)	65 cm	230 V AC	0.55 A	50 Hz	30 rpm	-
SG 10523	65 cm	230 V AC	0.55 A	50 Hz	30 rpm	868/915 MHz
<b>10-Series K</b>						
SG 10514	65 cm	230 V AC	0.52 A	50 Hz	30 rpm	-
<b>5-Series</b>						
SG 10715	65 cm	230 V AC	0.485 A	50-60 Hz	28 rpm	-

## C. OPERATING METHODS

See catalogue "controls" for details.

### Wall Switch



System can be operated by fixed wall switch.

**SG Control L**



*Various radio hand-held and wall transmitters available.*



*Silent Gliss Move App.*

**Smart by Silent Gliss**



*Open designed two-way communication system which allows to flawlessly integrate products with most major building management systems.*











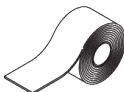

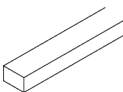
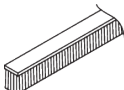

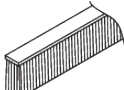

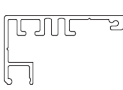

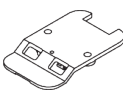

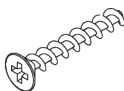



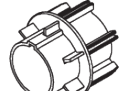
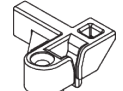

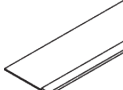

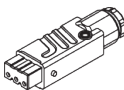
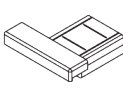
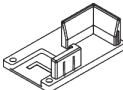

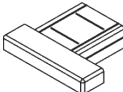
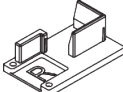
**D. WIRING**  
**DIAGRAMS**

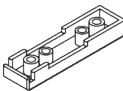
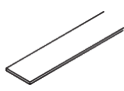

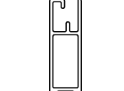









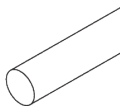
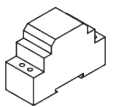
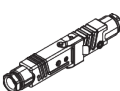
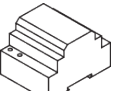
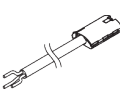
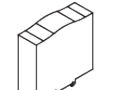

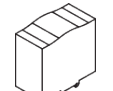
*Refer to Silent Gliss website.*

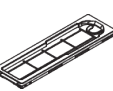
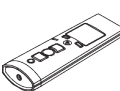
# PARTS

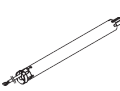
## A. STANDARD PARTS

	<b>SG 4226</b> Double tape 30 mm		<b>SG 11006</b> End cover left 90 mm		<b>SG 11060</b> Foam tape adhesive
	<b>SG 4508</b> Brush 5x7 mm		<b>SG 11007</b> End cover right 90 mm		<b>SG 11324</b> PT Screw Countersunk KA35x14
	<b>SG 4509</b> Brush 5x12 mm		<b>SG 11011</b> Clip		<b>SG 11418</b> Side guide case
	<b>SG 6791</b> Pan head screw 3.9x32		<b>SG 11013</b> Clip		<b>SG 11419</b> Side guide cover
	<b>SG 6933</b> PT Countersunk screw KA25x16		<b>SG 11017</b> Tube adapter		<b>SG 11421</b> Zip profile
	<b>SG 6936</b> PT Countersunk screw KA22x10		<b>SG 11019</b> Tube adapter		<b>SG 11473</b> Zip guide left
	<b>SG 6942</b> Pan head screw KA30x8		<b>SG 11025</b> Zip		<b>SG 11474</b> Zip guide right
	<b>SG 9917</b> Hirschmann portable socket-outlet STAK 3 N		<b>SG 11028</b> End cover left		<b>SG 11475</b> Side guide end cover left
	<b>SG 10284</b> O-Ring		<b>SG 11029</b> End cover right		<b>SG 11476</b> Side guide end cover right
	<b>SG 10522</b> Motor 230V AC, 20-Series S 3/30		<b>SG 11030</b> Cover		
	<b>SG 10668</b> PVC strip 10 mm		<b>SG 11034</b> Countersunk head screw 3.5x16		
	<b>SG 10993</b> Bottom bar		<b>SG 11035</b> Countersunk head screw 2.2x9.5		
	<b>SG 10996</b> Box case 90 mm		<b>SG 11037</b> Tube ø 60 mm		
	<b>SG 10997</b> Box cover 90 mm		<b>SG 11059</b> Pan head screw with flange M4x12		

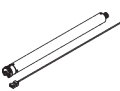
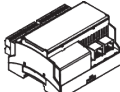
## B. OPTIONAL PARTS

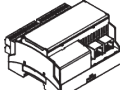
	<b>SG 4951</b> Bottom weight ø 8 mm		<b>SG 11263</b> Power supply 24V DC, 2 Ampere DIN Rail
	<b>SG 9916</b> Hirschmann plug set		<b>SG 11264</b> Power supply 24V DC, 3.8 Ampere DIN Rail
	<b>SG 10293</b> Cable 230V AC, 2/3/5/10 m		<b>SG 11265</b> Power supply 24V DC, 5 Ampere DIN Rail
	<b>SG 10300</b> Radio hand held 1 channel		<b>SG 11266</b> Power supply 24V DC, 10 Ampere DIN Rail
	<b>SG 10302</b> Radio hand held 5+1 channel		<b>SG 11460</b> Cover for Hirschmann plug
	<b>SG 10303</b> Radio hand held 10+2+1 channel		<b>SG 11480</b> Radio wall transmitter 1 channel
	<b>SG 10514</b> Tubular motor 230V AC, 10 Series S 3/30 K		<b>SG 11490</b> Radio wall transmitter 5+1 channel
	<b>SG 10523</b> Motor 230V AC, 20-Series S 3/30, radio receiver		
	<b>SG 10715</b> Tubular motor 230V AC, 5 Series S 6/28		
	<b>SG 10804</b> Radio hand held 15+5+1 channel		
	<b>SG 11251</b> Tubular motor 24V DC, 50-Series S 3/32		
	<b>SG 11260</b> Gateway Cedia		
	<b>SG 11261</b> Gateway KNX		
	<b>SG 11262</b> Expansion unit		





# SG 4780

---

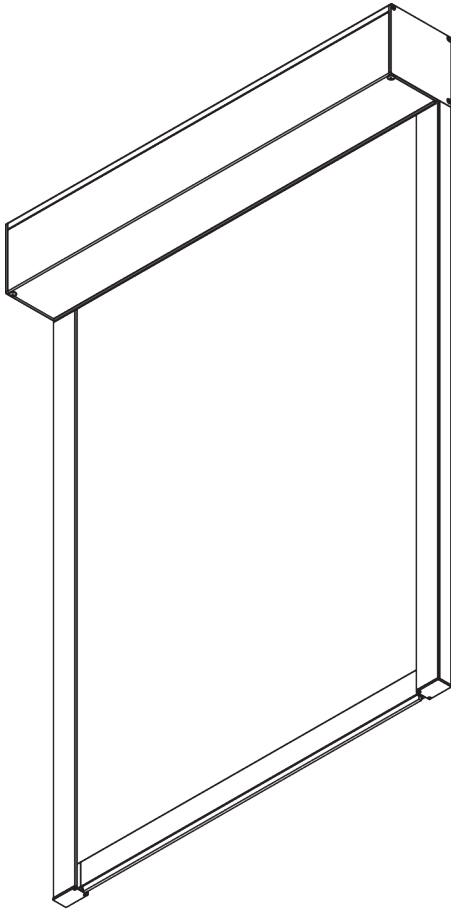

## PRODUCT INFORMATION

- **Operation:** motorised
- **Range:** L
- **Fitting:** ceiling, wall, recess
- **Colours:** white RAL 9016 or black RAL 9005, special colours possible
- **Fabrics:** refer to Silent Gliss fabric collection

### **Features:**

- Zip technology
- Quiet and fast motors
- Soft stop
- Various control options
- 40 mm side channel, pre-drilled fixing points

# SYSTEM SPECIFICATIONS

## A. SYSTEM DIMENSIONS



3 m



65 cm

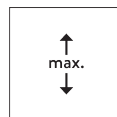

3 m

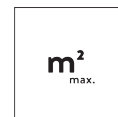

9 m<sup>2</sup>



6 kg

## B. PROFILE

### Profile information

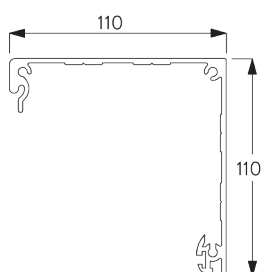

**SG 10998**

Box case 110 mm

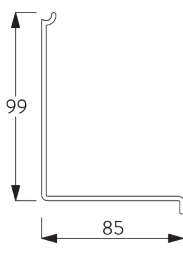

**SG 10999**

Box cover 110 mm

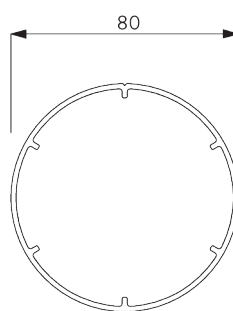

**SG 11003**

Tube ø 80 mm

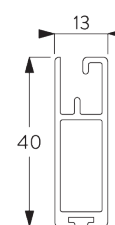

**SG 10993**

Bottom bar

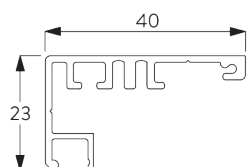

**SG 11418**

Side guide case

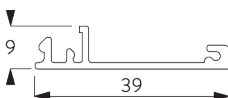

**SG 11419**

Side guide cover

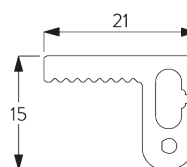

**SG 11421**

Zip profile

## C. HOW TO MEASURE

### Inside fitting

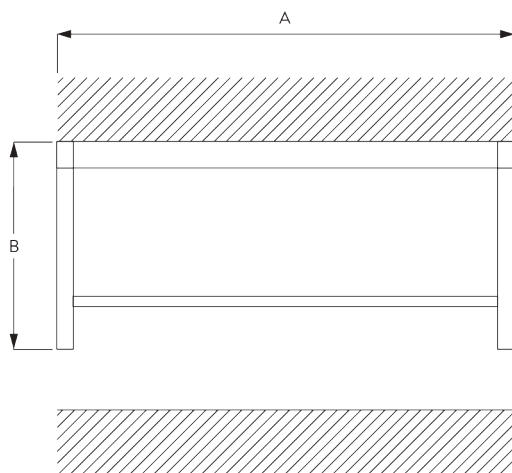

A: System width  
B: System height

### Face fitting

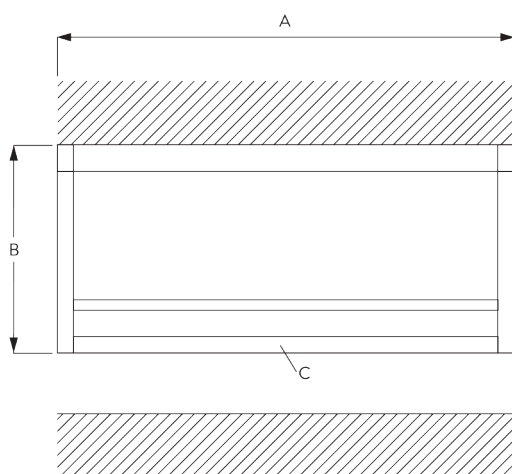

A: System width  
B: System height  
C: Optional: end profile (SG 11418 / SG 11419)

## D. SPECIFICATION TEXT

### EN

Silent Gliss SG 4780 Electrically Operated Dim-Out Roller Blind System with SG Series 20 motors. For blinds up to 3m wide by 3m drop, max 9sq. m. Supplied complete and made to measure comprising aluminium headbox SG 10998-9 (110 mm), side profiles SG 11418 / SG 11419 and bottom hem bar SG 10993 in white or black powder coat finish as standard. Fabric edges retained by two component zip profile SG 11421. by mains switch (not supplied) or mains switching by third party control system or remote control system. All wiring to be strictly in accordance with Silent Gliss wiring diagrams. Fabric to be chosen from the Silent Gliss fabric range, Price Group 1R / 2R / 3R.

### SV

Silent Gliss SG 4780 mörklägningsrullgardin med motor serie 20. För system max 3 x 3 m, eller totalt max 9 m<sup>2</sup>. Levereras komplett i kundmått bestående av toppkassett i aluminium SG 10998-9 (110 mm), sidoprofiler SG 11418/ SG 11419 samt tyngdprofil SG 10993 i vit eller svart epoxy lack. Textilens kant försedd med zip profil SG 11421. Integrerad 230V motor SG 10522/ (SG 10523 radiomottagare) vänster / höger sida. Styrning via väggkontakt (ej inkluderad), via fjärrkontroll eller via externt styrsystem. All elinstallation skall följa Silent Gliss kopplingschema. Textil från Silent Gliss textilprogram i prisgrupp 1-3.

### NO

Silent Gliss SG 4780 Mørkleggende rullegardin med motor serie 20. For system inntil 3 x 3 m, eller totalt max 9 m<sup>2</sup>. Levereras komplett måltilpasset. Består av toppkasse i aluminium SG 10998-9 (110 mm), sideprofiler SG 11418 / SG 11419 samt tyngdeprofil SG 10993 i hvit eller svart epoxy lakk. Sidene på tekstilet er festet med zip profil SG 11421. Integrert 230V motor SG 10523/ (SG 10321 radiomottaker) venstre eller høyre side. Betjenes med veggbryter (ikke inkludert), fjernkontroll eller via eksternt styrsystem. Ved alle elektriske installasjoner skal Silent Gliss koblingskjema benyttes. Tekstiler fra Silent Gliss tekstilkolleksjon i prisgrupp 1-3.

# FITTING

## A. FITTING INFORMATION

For detailed fitting information, visit the [Silent Gliss website](#).

### Inside fitting - fixing points

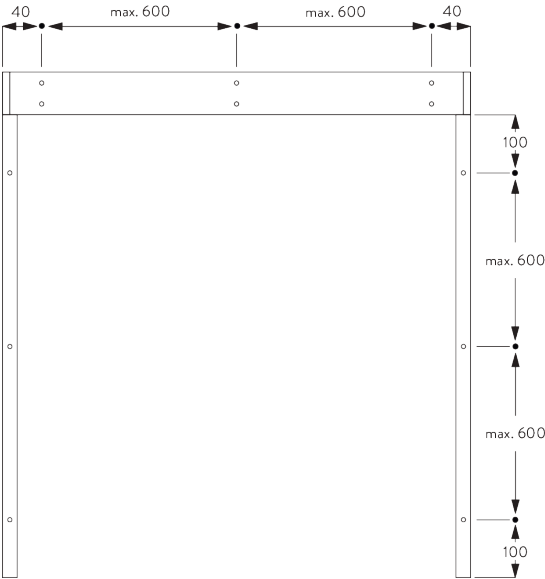

### Face fitting - fixing points

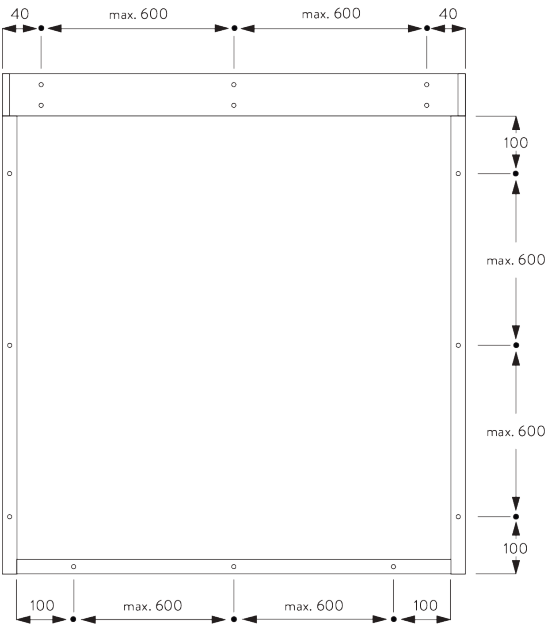

**B. CEILING FITTING**

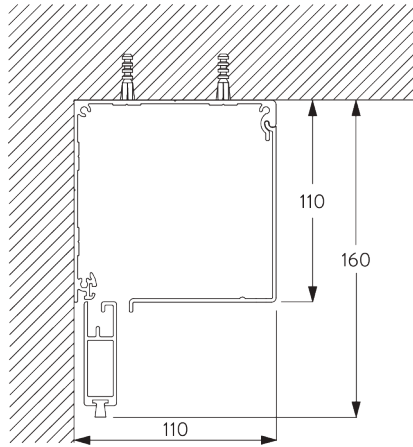

**C. WALL FITTING**

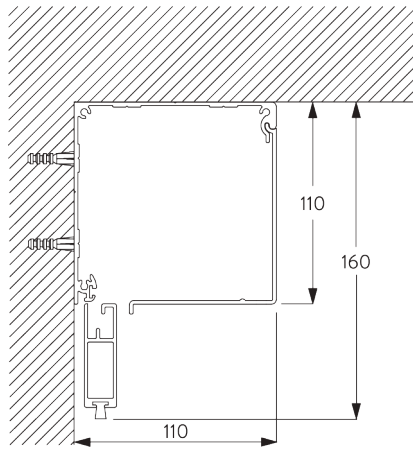

**D. RECESS FITTING**

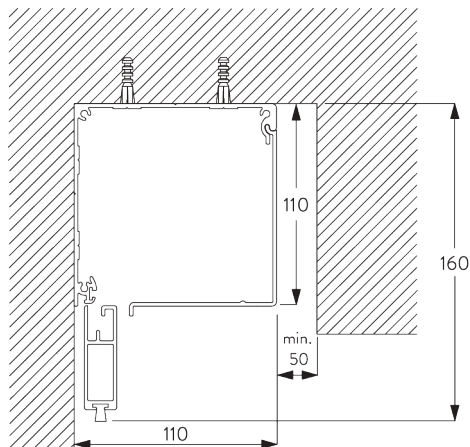

**E. SIDE PROFILES**  
**SG 11418 / SG 11419**

Inside fitting

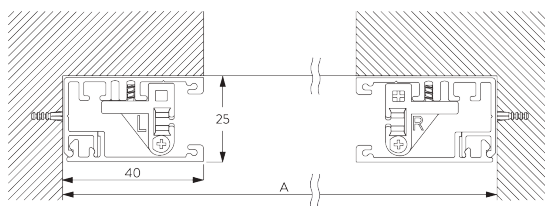

A: System width

## Face fitting

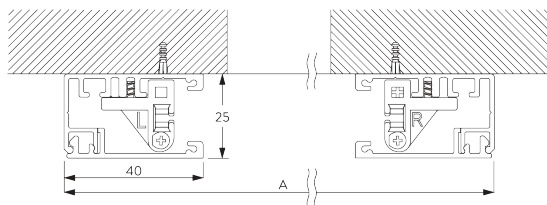

A: System width

# MOTORS & CONTROLS

## A. MOTOR FEATURES

Motors	50-Series	20-Series	20-Series	10-Series K	5-Series
	SG 11251	SG 10523	SG 10522	SG 10514	SG 10715

### Motor Features

Soft stop	•	•	•		
Electronic end-stop	•	•	•		
Electronic revolution counter (unlimited revolution)	•	•	•		
Mechanical end-stop				•	•
Mechanical revolution counter (limited revolution)				•	•
Two intermediate positions possible		•			
Bottom bar alignment	•				
Noiseless stop		•	•	•	
Parallel wiring possible without additional relays		•	•		
Disconnectable motor cable	•	•	•		
IP class	IP 30	IP 44	IP 44	IP 44	IP 44

### Control Features

Mains power control		•	•	•	•
SG Control L (built-in receiver)		•			
Smart by Silent Gliss	•				
Suitable for most major home automation systems (with suitable interface)		•	•	•	•

## B. MOTOR SPECIFICATIONS

Motors	Min. system width	Voltage	Current	Frequency	Speed	Frequency receiver
<b>50-Series (Smart by Silent Gliss)</b>						
SG 11251	65 cm	24 V DC	1.5 A	-	32 rpm	-
<b>20-Series</b>						
SG 10522 (standard)	65 cm	230 V AC	0.55 A	50 Hz	30 rpm	-
SG 10523	65 cm	230 V AC	0.55 A	50 Hz	30 rpm	868/915 MHz
<b>10-Series K</b>						
SG 10514	65 cm	230 V AC	0.52 A	50 Hz	30 rpm	-
<b>5-Series</b>						
SG 10715	65 cm	230 V AC	0.485 A	50-60 Hz	28 rpm	-

**C. OPERATING  
METHODS**

See catalogue "controls" for details.

Wall Switch



System can be operated by fixed wall switch.

SG Control L



Various radio hand-held and wall transmitters available.



Silent Gliss Move App.

Smart by Silent Gliss



Open designed two-way communication system which allows to flawlessly integrate products with most major building management systems.











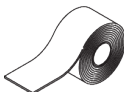

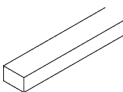
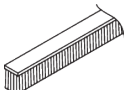
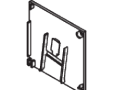

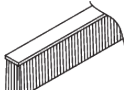
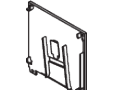
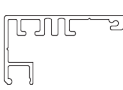

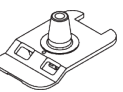

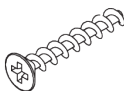
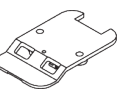

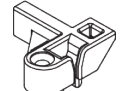

**D. WIRING  
DIAGRAMS**

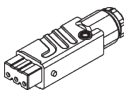
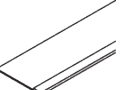
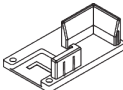

Refer to Silent Gliss website.

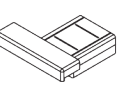
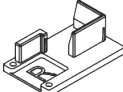

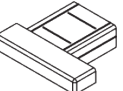
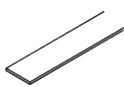
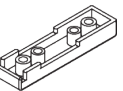
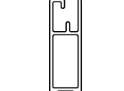
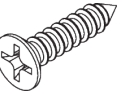

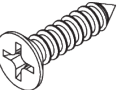
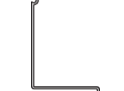
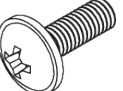





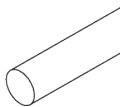
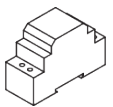
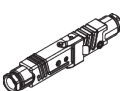
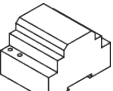
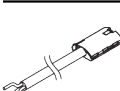
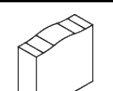

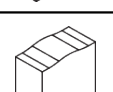
# PARTS

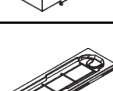
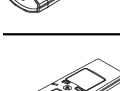
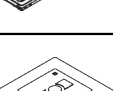
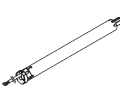
## A. STANDARD PARTS

	<b>SG 4226</b> Double tape 30 mm		<b>SG 11003</b> Tube ø 80 mm		<b>SG 11060</b> Foam tape adhesive
	<b>SG 4508</b> Brush 5x7 mm		<b>SG 11008</b> End cover left 110 mm		<b>SG 11324</b> PT Screw Countersunk KA35x14
	<b>SG 4509</b> Brush 5x12 mm		<b>SG 11009</b> End cover right 110 mm		<b>SG 11418</b> Side guide case
	<b>SG 6791</b> Pan head screw 3.9x32		<b>SG 11011</b> Clip		<b>SG 11419</b> Side guide cover
	<b>SG 6933</b> PT Countersunk screw KA25x16		<b>SG 11013</b> Clip		<b>SG 11421</b> Zip profile
	<b>SG 6936</b> PT Countersunk screw KA22x10		<b>SG 11020</b> Tube adapter		<b>SG 11473</b> Zip guide left
	<b>SG 6942</b> Pan head screw KA30x8		<b>SG 11022</b> Tube adapter		<b>SG 11474</b> Zip guide right
	<b>SG 9917</b> Hirschmann portable socket-outlet STAK 3 N		<b>SG 11025</b> Zip		<b>SG 11475</b> Side guide end cover left
	<b>SG 10284</b> O-Ring		<b>SG 11028</b> End cover left		<b>SG 11476</b> Side guide end cover right
	<b>SG 10522</b> Motor 230V AC, 20-Series S 3/30		<b>SG 11029</b> End cover right		
	<b>SG 10668</b> PVC strip 10 mm		<b>SG 11030</b> Cover		
	<b>SG 10993</b> Bottom bar		<b>SG 11034</b> Countersunk head screw 3.5x16		
	<b>SG 10998</b> Box case 110 mm		<b>SG 11035</b> Countersunk head screw 2.2x9.5		
	<b>SG 10999</b> Box cover 110 mm		<b>SG 11059</b> Pan head screw with flange M4x12		

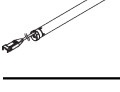
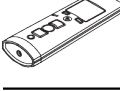

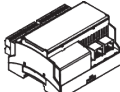
## B. OPTIONAL PARTS

	<b>SG 4951</b> Bottom weight ø 8 mm		<b>SG 11263</b> Power supply 24V DC, 2 Ampere DIN Rail
	<b>SG 9916</b> Hirschmann plug set		<b>SG 11264</b> Power supply 24V DC, 3.8 Ampere DIN Rail
	<b>SG 10293</b> Cable 230V AC, 2/3/5/10 m		<b>SG 11265</b> Power supply 24V DC, 5 Ampere DIN Rail
	<b>SG 10300</b> Radio hand held 1 channel		<b>SG 11266</b> Power supply 24V DC, 10 Ampere DIN Rail
	<b>SG 10302</b> Radio hand held 5+1 channel		<b>SG 11460</b> Cover for Hirschmann plug
	<b>SG 10303</b> Radio hand held 10+2+1 channel		<b>SG 11480</b> Radio wall transmitter 1 channel
	<b>SG 10514</b> Tubular motor 230V AC, 10 Series S 3/30 K		<b>SG 11490</b> Radio wall transmitter 5+1 channel
	<b>SG 10523</b> Motor 230V AC, 20-Series S 3/30, radio receiver		
	<b>SG 10715</b> Tubular motor 230V AC, 5 Series S 6/28		
	<b>SG 10804</b> Radio hand held 15+5+1 channel		
	<b>SG 11251</b> Tubular motor 24V DC, 50-Series S 3/32		
	<b>SG 11260</b> Gateway Cedia		
	<b>SG 11261</b> Gateway KNX		
	<b>SG 11262</b> Expansion unit		





## ***The Architects of Silence***

***Silent Gliss is the leading global supplier of premium interior window treatments. Since 1952 we have been tirelessly committed to the development of the worlds` smoothest, quietest systems using state of the art technology.***

*Driven by customer needs, Silent Gliss offers functional and durable products. Expert technical advice coupled with installation and support services complete the offer. Silent Gliss stands for innovative, sustainable, tailor made solutions, exceptional design and first-class quality.*

### **Silent Gliss Nordic AB**

Travbanegatan 9  
213 77 Malmö  
Sweden  
**T** +46 40 55 52 50  
info@silentgliss.se

Byggdøy Allé 111A  
0273 Oslo  
Norway  
**T** +47 24 11 80 60  
info@silentgliss.no

Denmark  
**T** +45 36 77 67 00  
info@silentgliss.dk

**silentgliss.se**  
**silentgliss.no**  
**silentgliss.dk**