

SG 4930

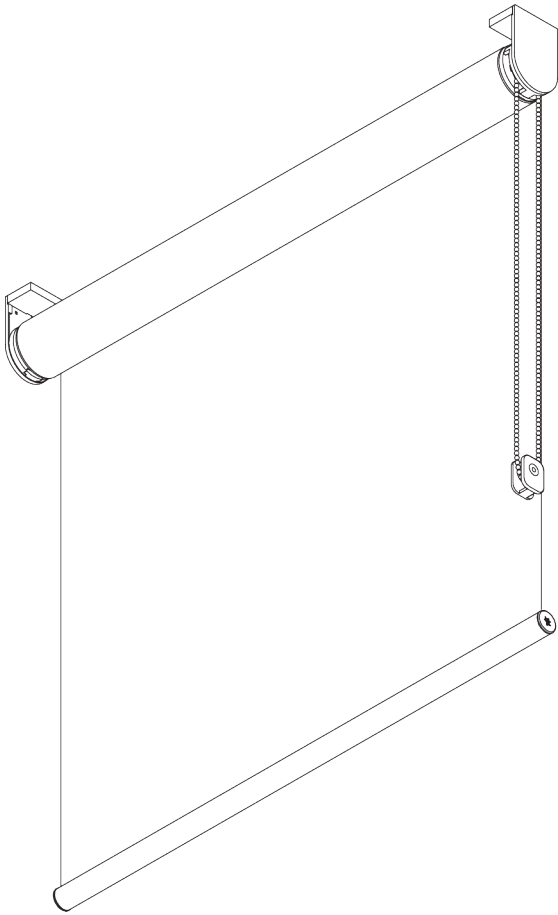

PRODUCT INFORMATION

- **Operation:** chain
- **Range:** M - L
- **Fitting:** ceiling, wall, recess
- **Colours:** white RAL 9016, grey RAL 7035, black RAL 9005, special colours possible
- **Fabrics:** refer to Silent Gliss fabric collection

Features:

- 5-to-1 gear drive
- Stainless steel bead chain
- Two connected systems
- Click-in brackets
- Fascia, box, installation profile

04/2024/V2

SYSTEM SPECIFICATIONS

A. SYSTEM DIMENSIONS

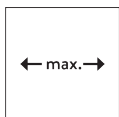

Single system: 3.4 m
Double system: 6.8 m



65 cm



5 m



Single system: 17 m²
Double system: 30 m²



7 kg

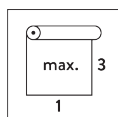

Recommended width /
height ratio
max. 1:3

B. PROFILE

Profile information

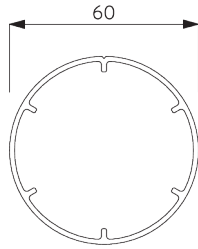

SG 11037
Tube ø 60 mm



SG 10760
Bottom bar

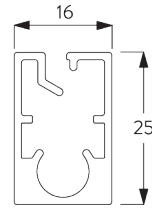

SG 10770
Bottom bar

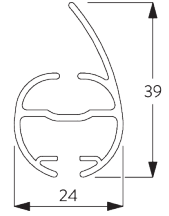

SG 4903
Bottom bar

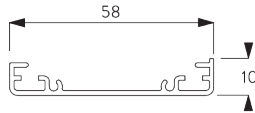

SG 11181
Installation profile



SG 11530
Installation profile fascia 110 mm

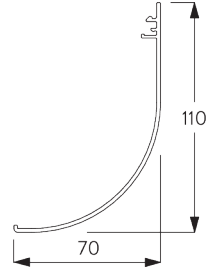

SG 11531
Fascia round 110 mm

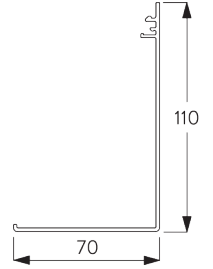

SG 11532
Fascia square 110 mm

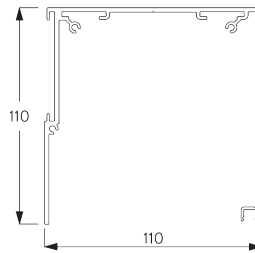

SG 11533
Box case 110 mm

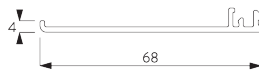

SG 11534
Box cover 110 mm

C. HOW TO MEASURE

incl. bracket covers

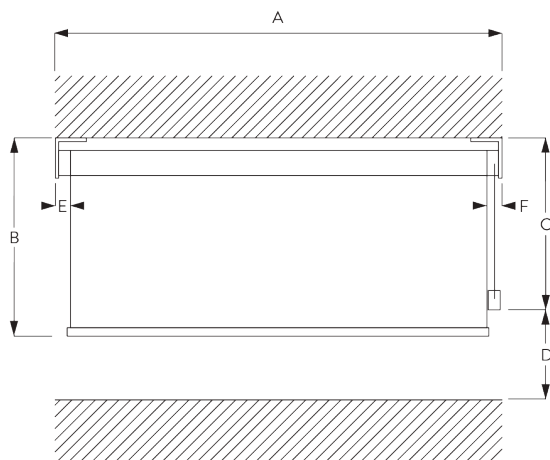

A: System width
B: System height
C: Chain height
D: Safety Retainer SG 10731 min. 150 cm above floor
E: Light gap: 18 mm
F: Light gap operation side: 25 mm

Note:
All measurements include 2 mm for bracket cover per side!

Fascia / Box

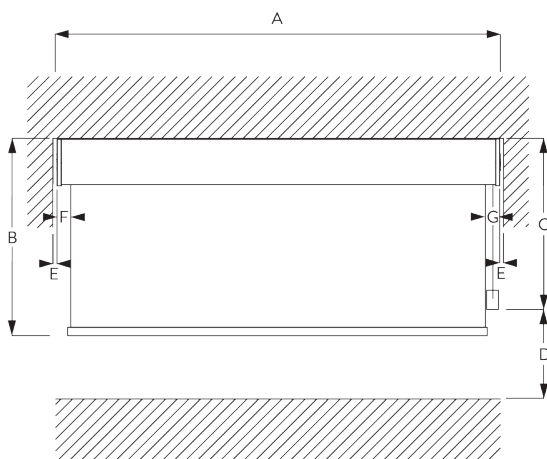

- A: System width
- B: System height
- C: Chain height
- D: Safety Retainer SG 10731 min. 150 cm above floor
- E: Gap: min. 10 mm (when cover is used)
- F: Light gap: 20 mm
- G: Light gap operation side: 27 mm

D. SPECIFICATION

TEXT

EN

Silent Gliss Chain Operated Roller Blind System SG 4930. Roller blind system for medium to large size blind applications up to 3.4m wide. Supplied made to measure and complete with barrel SG 11037, gear and integrated brake to ensure smooth operation and exact stop positions without slippage. Fixed to wall / ceiling / inside recess with SG 11172 / 11175 brackets with side cover SG 11173/11174 to ensure neat appearance. Brackets and hardware in white/grey/black finish. Optional installation profile SG 11181 for easy installation with clamps SG 11180. Optional side guide wires. Double system option can be operated simultaneously by a single chain fitted with SG 11183 connecting bolt. Bottom bar in white/grey/black SG 4903/10993. Compliant to Child Safety legislation EN 13120. Fabric to be chosen from the Silent Gliss fabric range, Price Group 1-4.

SV

Silent Gliss SG 4930 kedjemanövrerat rullgardinsystem. Rullgardinsystem för installationer upp till 3.4 m bredd. Levereras komplett i specificerat mått innefattande anodiserat rör SG 11037, 60 mm, med utväxling och broms för att garantera lätt och steglös upp- och nerrullning. Vägg/tak och nischmontering med fästen SG 11172 / SG 11175 samt täckplattor SG 11173/11174 i vitt/grått eller svart. Alternativt med installationsprofil SG 11181 som monteras med SG fästen 11180. Sidewire som tillbehör. Dubbelsystem för manövrering med 1 kulkedja via kopplingsbeslag SG 11183. Monterad tyngdprofil i aluminium i finish vitt/grått/svart med SG 4903/10993). Uppfyller barnsäkerhetsnormen EN 13120. Textil från Silent Gliss textilprogram i prisgrupp 1-4.

NO

Silent Gliss SG 4930 Kjedefbetjent rullegardinsystem. Rullegardinsystem for maks. bredde på 3,4 meter. Leveres komplett på spesialmål med anodisert rør integrert, SG11037, 60mm, med utveksling og brems for å garantere lett og trinnløs opp- og nedrulling. Tak-,vegg- og nisjemontering med feste SG11172 / SG11175 samt dekkplate SG 11173/11174 i hvit, grå eller svart. Alternativt monteringsprofil SG 11181 som monteres med feste SG 11180. Sidewire som tilbehør. Koblingsbeslag SG 11183 for betjening av dobbelt system med kulekjede. Montert tyngdeprofil i pulverlakkert aluminium i hvit/alu/svart med SG 4903/10993. Oppfyller barnesikkerhetsnormen EN13120. Tekstil fra Silent Gliss kolleksjon i prisgruppe 1-4.

DA

Silent Gliss rullegardinsystem med kædestyring SG 4930. Rullegardinsystem til mellem til store installationer med op til 3,4m bredde. Leveres i ønsket længde og komplet med aluminiumrør SG 11037, gear og integreret bremse, der sørger for trinløs betjening og nøjagtige stopstillinger uden glidning. Fastgøres i væggen / loftet / indfældes med beslagene SG 11172 / 11175 med sideafdækning SG 11173/11174, så det ser pænt ud. Beslag og armaturer i hvid/grå/sort finish. Alternativt med installationsprofil SG 11181 for nem installation med klemmerne SG 11180. Sidewirer som tilbehør. Valgfrit dobbelt system kan betjenes samtidigt med en enkelt kæde med en SG 11183 tilslutningsbolt. Tyngdeprofil i hvidt/gråt/sort SG 4903/10993. Overholder lovgivning om børnesikkerhed efter EN 13120. Stoffet vælges fra Silent Gliss stofprogrammet, prisgruppe 1-4.

FITTING

A. FITTING INFORMATION

For detailed fitting information, visit the Silent Gliss website.

Fixing points



Brackets (wall / ceiling)

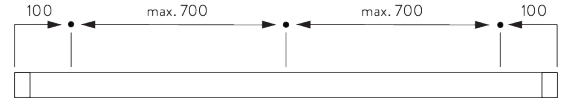

Fascia / box & installation profile SG 11181 (wall / ceiling)

B. CEILING FITTING

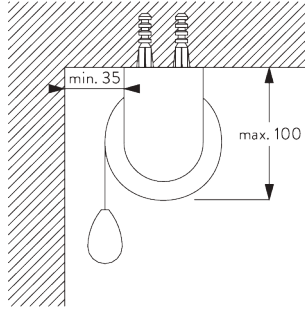

Brackets

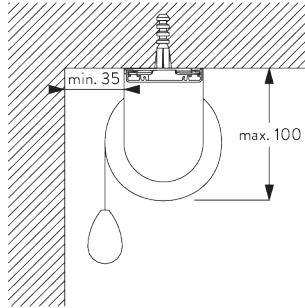

Installation profile SG 11181 and clamp SG 11180

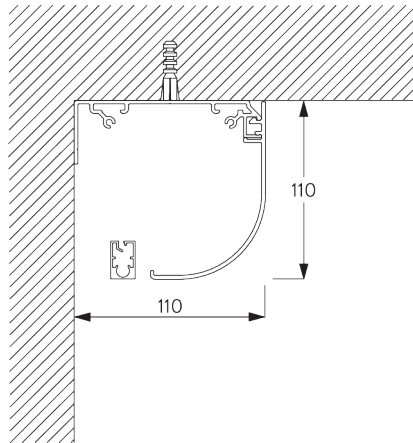

Fascia round

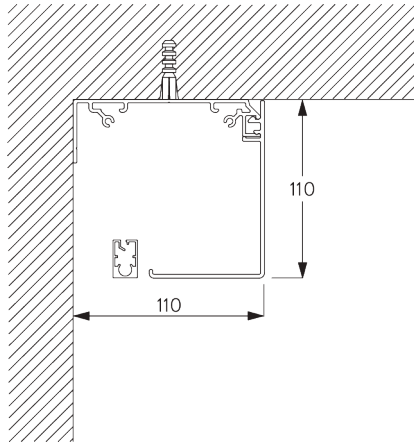

Fascia square

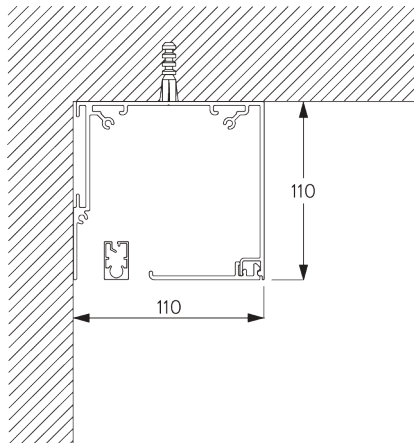

Box

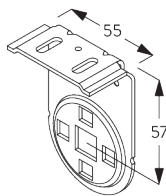

SG 11172
Bracket

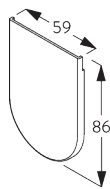

SG 11173
Bracket cover

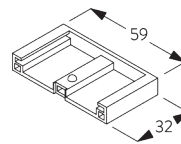

SG 11174
Bracket cover

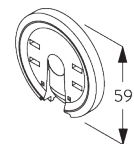

SG 11175
Click flange

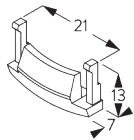

SG 11179
Cover

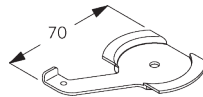

SG 11180
Clamp

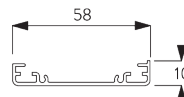

SG 11181
Installation profile

C. WALL FITTING

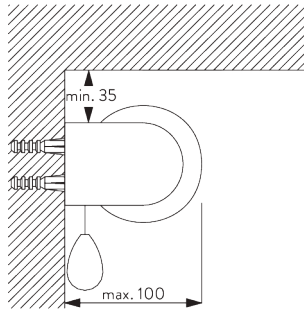

Brackets

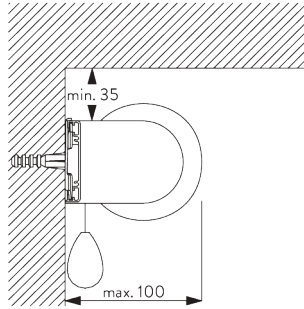

Installation profile SG 11181 and clamp SG 11180

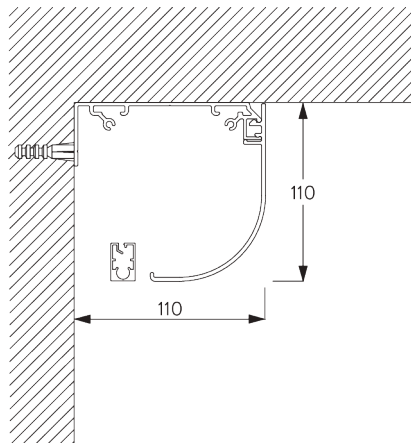

Fascia round

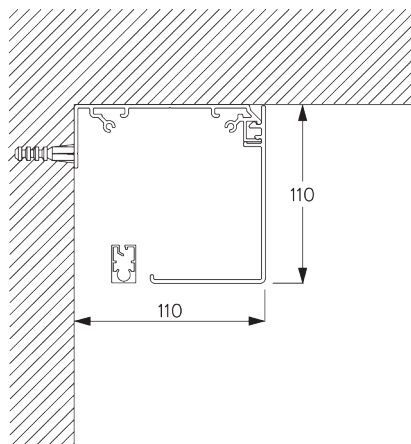

Fascia square

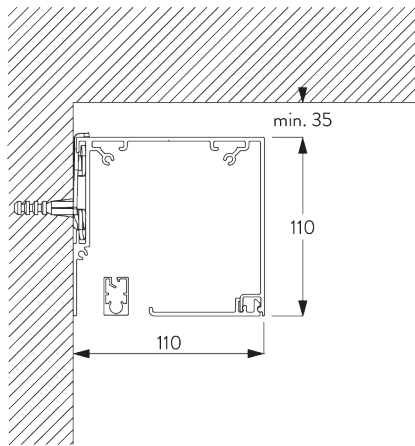

Box and clamp SG 11180

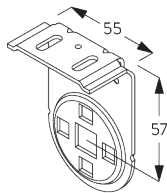

SG 11172
Bracket

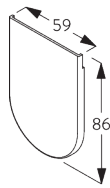

SG 11173
Bracket cover

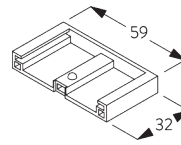

SG 11174
Bracket cover

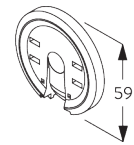

SG 11175
Click flange

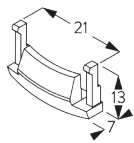

SG 11179
Cover

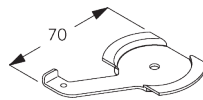

SG 11180
Clamp

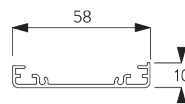

SG 11181
Installation profile

D. RECESS FITTING

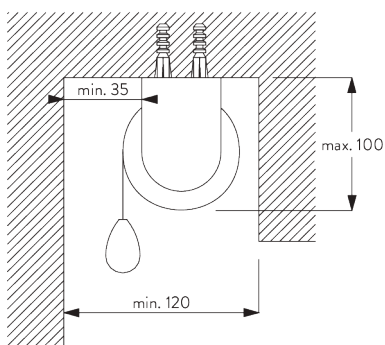

Brackets

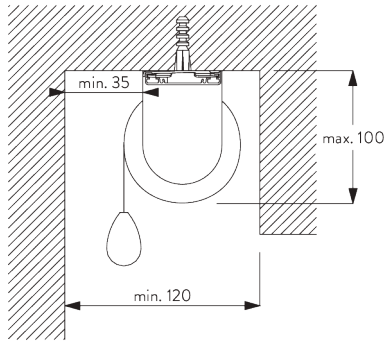

Installation profile SG 11181 and clamp SG 11180

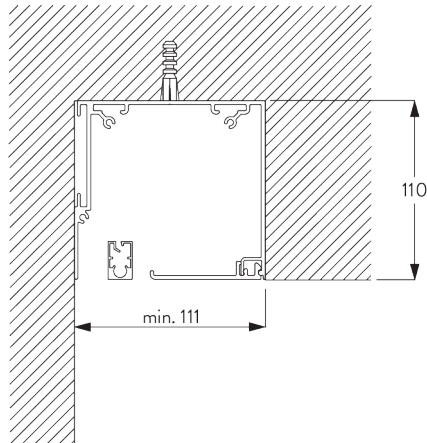

Box

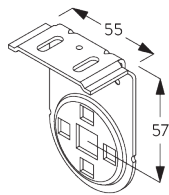

SG 11172
Bracket

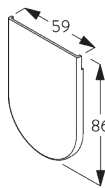

SG 11173
Bracket cover

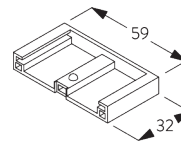

SG 11174
Bracket cover

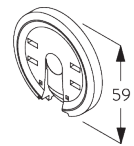

SG 11175
Click flange

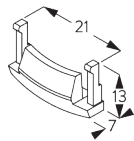

SG 11179
Cover

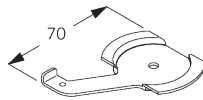

SG 11180
Clamp

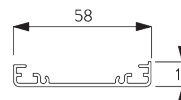

SG 11181
Installation profile

**E. FITTING WITH
SIDE GUIDE
OPTION**

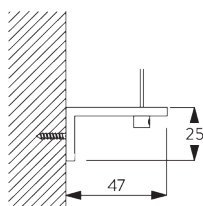

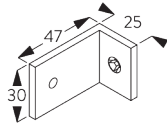

SG 3036
Bracket 47 mm

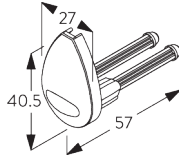

SG 4944
Side guide end cover

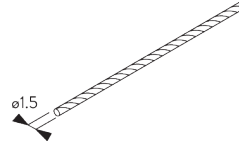

SG 4948
Side guide wire ø 1.5 mm

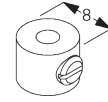

SG 8249
Side guide device

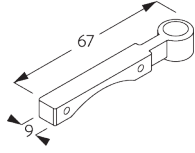

SG 1182
Side guide wire holder

SYSTEM OPTIONS

A. FABRIC ROLL-OFF

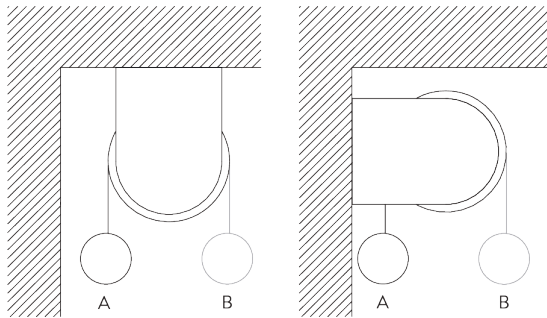

A: Fabric roll-off window side (standard)
B: Fabric roll-off room side (option)

B. INSTALLATION PROFILE

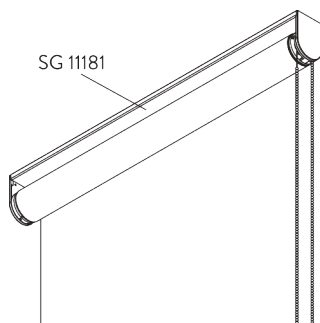

C. SIDE GUIDES

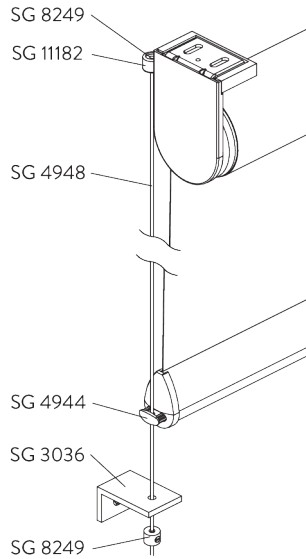

Additional parts:

- 2x SG 3036 Bracket
- 2x SG 4944 Side guide end cover
- 2x SG 4948 Side guide wire \varnothing 1.5 mm
- 4x SG 8249 Side guide device
- 2x SG 11182 Side guide wire holder

Note:

- Light gaps increase when side-guide option is used
- Up to 15° from vertical
- Only applicable with bottom bar SG 4903

D. TWO CONNECTED SYSTEMS

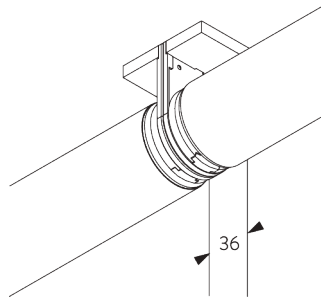

Additional parts:

- 1x SG 11175 Click flange
- 1x SG 11183 Connecting bolt
- 2x SG 11184 Connection bracket cover
- 1x SG 11195 Connection tube adapter

E. FASCIA / BOX

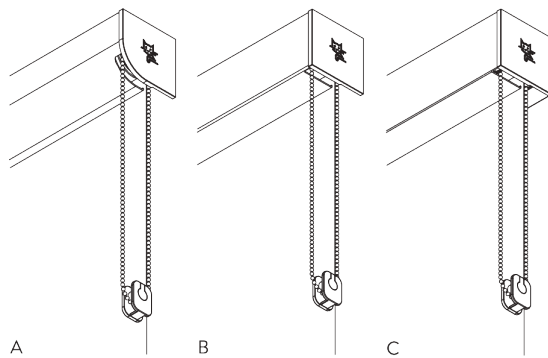

A: Fascia round

B: Fascia square

C: Box

Size:









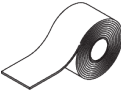

- 110 x 110 mm

Note:



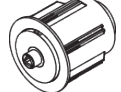

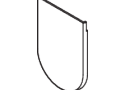
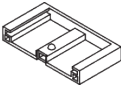

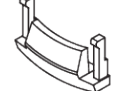
- Only applicable with bottom bar SG 10770
- Not possible with connected systems





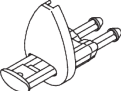

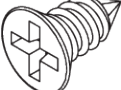
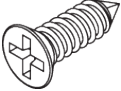
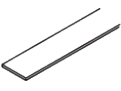
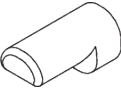
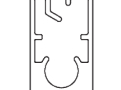
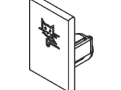

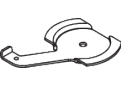
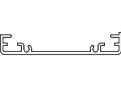
PARTS

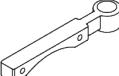
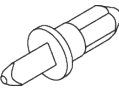
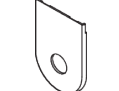
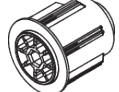
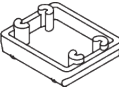
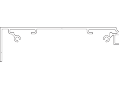
A. STANDARD PARTS

	SG 4223 PVC strip 14 mm
	SG 4226 Double tape 30 mm
	SG 4845 Bead chain metal ø 4.5 mm
	SG 10731 Child safety retainer set
	SG 10760 Bottom bar
	SG 10761 End cover
	SG 10962 Chain drive
	SG 11037 Tube ø 60 mm
	SG 11165 Tube adapter
	SG 11172 Bracket
	SG 11173 Bracket cover
	SG 11174 Bracket cover
	SG 11175 Click flange
	SG 11179 Cover

B. OPTIONAL PARTS

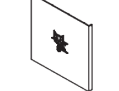
	SG 3036 Bracket 47 mm
	SG 4903 Bottom bar
	SG 4944 Side guide end cover
	SG 4948 Side guide wire ø 1.5 mm
	SG 8249 Side guide device
	SG 10139 Countersunk screw 2.9x6.5
	SG 10498 Countersunk screw 2.9x9.5
	SG 10668 PVC strip 10 mm
	SG 10707 End stop
	SG 10770 Bottom bar
	SG 10771 End cover
	SG 11178 End cover
	SG 11180 Clamp
	SG 11181 Installation profile

	SG 11182 Side guide wire holder
	SG 11183 Connection bolt
	SG 11184 Connection bracket cover
	SG 11195 Connection tube adapter
	SG 11311 Bracket spacer
	SG 11530 Installation profile fascia 110 mm
	SG 11531 Fascia round 110 mm
	SG 11532 Fascia square 110 mm
	SG 11533 Box case 110 mm
	SG 11534 Box cover 110 mm
	SG 11537 Bracket cover round left 110 mm
	SG 11538 Bracket cover round right 110 mm
	SG 11539 Bracket cover square left 110 mm
	SG 11540 Bracket cover square right 110 mm



SG 11544

Bracket left 110 mm



SG 11545

Bracket right 110 mm
