

SG 4730

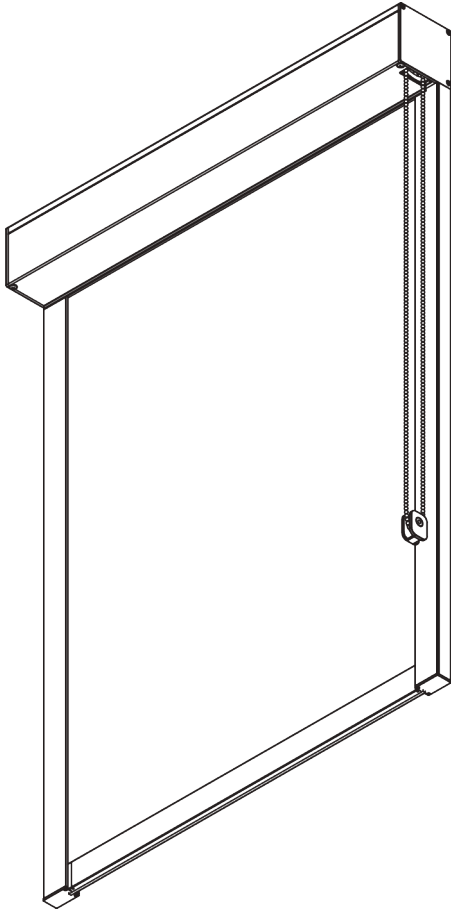

PRODUCT INFORMATION

- **Operation:** chain
- **Range:** M
- **Fitting:** ceiling, wall, recess
- **Colours:** white RAL 9016 or black RAL 9005, special colours possible
- **Fabrics:** refer to Silent Gliss fabric collection

Features:

- Zip technology
- Stainless steel bead chain
- 2-to-1 gear drive
- 40 mm side channel, pre-drilled fixing points

SYSTEM SPECIFICATIONS

A. SYSTEM DIMENSIONS



2.2 m

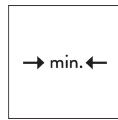

65 cm

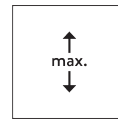

2.4 m



5.3 m²



3.7 kg

B. PROFILE

Profile information

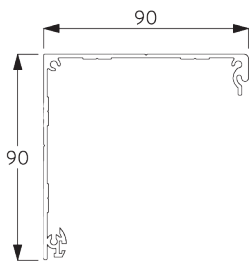

SG 10996

Box case 90 mm

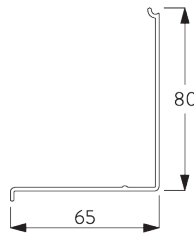

SG 10997

Box cover 90 mm

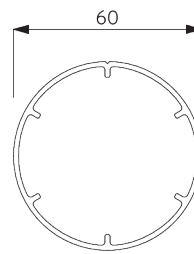

SG 11037

Tube ø 60 mm

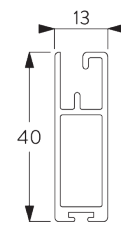

SG 10993

Bottom bar

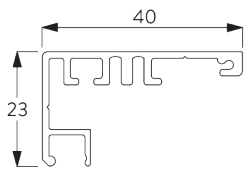

SG 11418

Side guide case

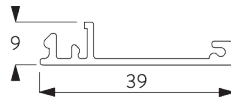

SG 11419

Side guide cover

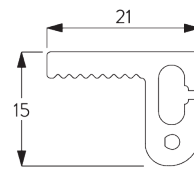

SG 11421

Zip profile

C. HOW TO MEASURE

Inside fitting

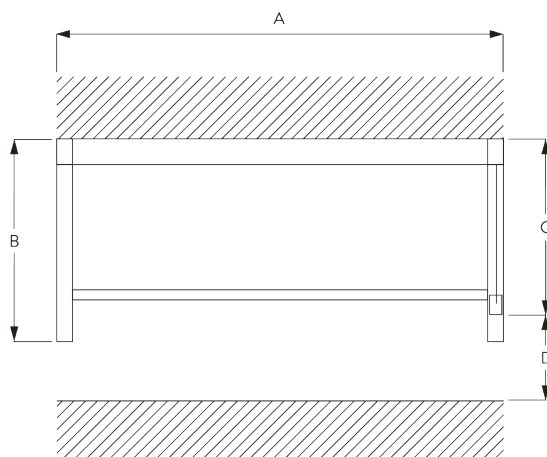

A: System width

B: System height

C: Chain height

D: Safety Retainer SG 10731 min. 150 cm above floor

Face fitting

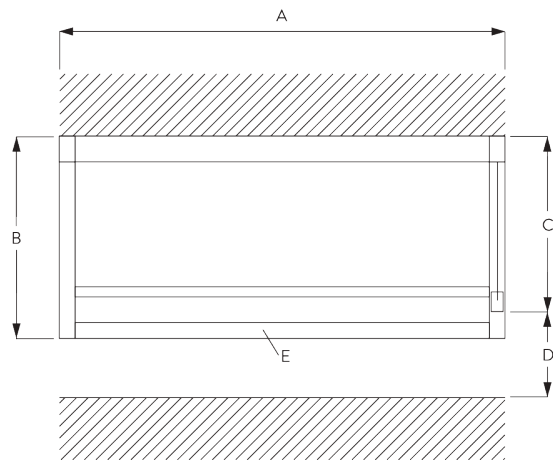

- A: System width
- B: System height
- C: Chain height
- D: Safety Retainer SG 10731 min. 150 cm above floor
- E: Optional: end profile (SG 11418 / SG 11419)

D. SPECIFICATION

TEXT

EN

Silent Gliss SG 4730 Chain Operated Dim-Out Roller Blind System. For blinds up to 2.2m wide by 2.4m drop, max 5.3 sq. m. Supplied complete and made to measure comprising aluminium headbox SG 10996-7 (90 mm), side profiles SG 11418 / SG 11419 and bottom hem bar SG 10993 in white or black powder coat finish as standard. Fabric edges retained by two component zip profile SG 11421. Operation by stainless steel bead chain with chain retainer SG 10731. Compliant to Child Safety Legislation EN 13120. Fabric to be chosen from the Silent Gliss fabric range, Price Group 1R / 2R / 3R.

SV

Silent Gliss SG 4730 mörkläggningsrullgardin med kulkedja. För system max 2,2 x 2,4 m, eller totalt max 5,3 m². Levereras komplett i kundmått bestående av toppkassett i aluminium SG 10996-7 (90 mm), sidoprofiler SG 11418 / SG 11419 samt tyngdprofil SG 10993 i vit eller svart epoxy lack. Textilens kant försedd med zip profil SG 11421. Manövrering med rostfri kulkedja av stål samt väggfäste SG 10731. Textil från Silent Gliss textilprogram i prisgrupp 1-3.

NO

Silent Gliss SG 4730 Mørkleggende rullegardin med kulekjede. For system inntil 2,2 x 2,4 m, eller totalt max 5,3 m². Levereras komplett måltilpasset. Består av toppkasse i aluminium SG 10996-7 (90 mm), sideprofiler SG 11418 / SG 11419 samt tyngdeprofil SG 10993 i hvit eller svart epoxy lakk. Sidene på tekstilet er festet med zip profil SG 11421. Betjening med rustriitt kulekjede samt veggfeste SG 10731. Tekstiler fra Silent Gliss tekstilkolleksjon i prisgrupp 1-3.

FITTING

A. FITTING INFORMATION

For detailed fitting information, visit the Silent Gliss website.

Inside fitting - fixing points

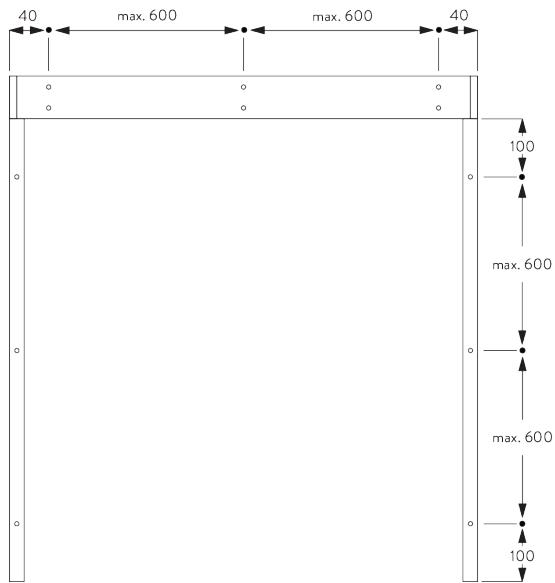

Face fitting - fixing points

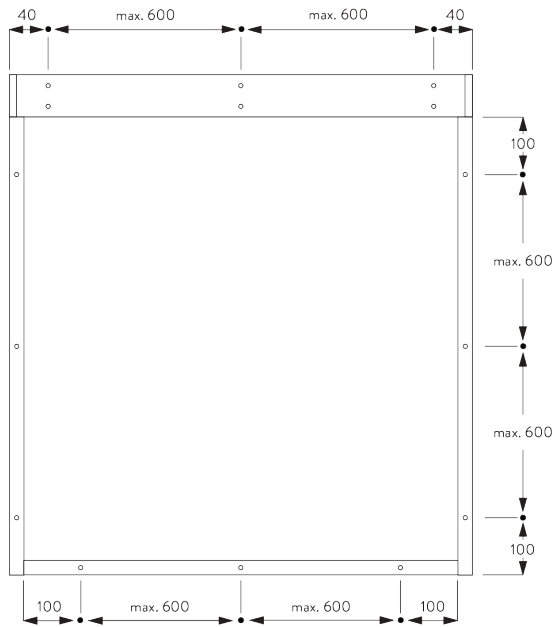

B. CEILING FITTING

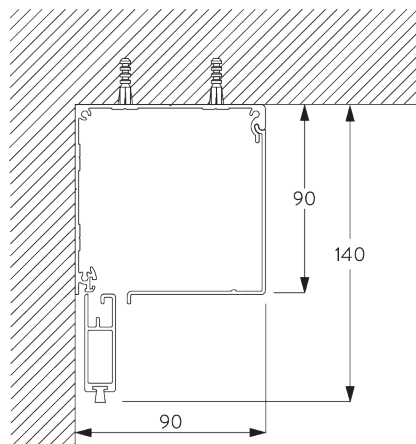

C. WALL FITTING

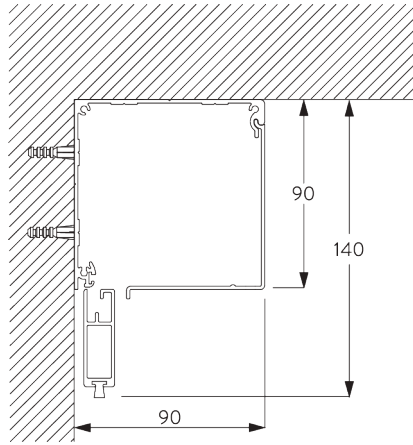

D. RECESS FITTING

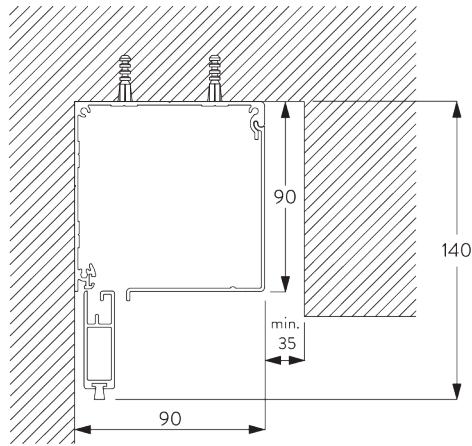

E. SIDE PROFILES
SG 11418 / SG 11419

Inside fitting

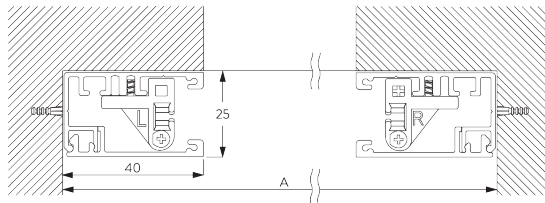

A: System width



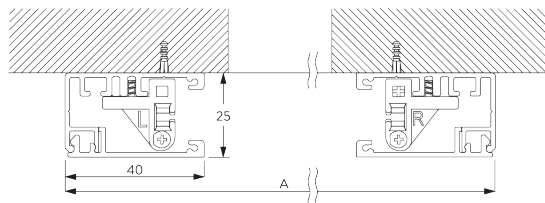







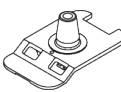
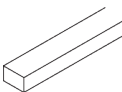
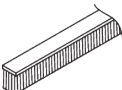

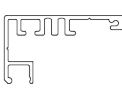
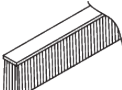





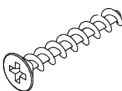
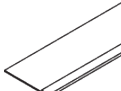

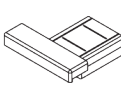

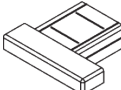
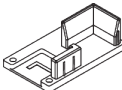
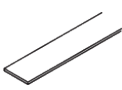
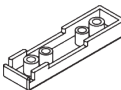
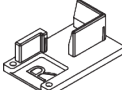
Face fitting

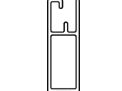

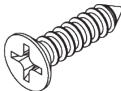
A: System width

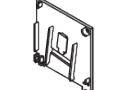
PARTS

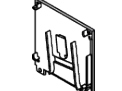
A. STANDARD PARTS

	SG 4226 Double tape 30 mm		SG 11011 Clip		SG 11060 Foam tape adhesive
	SG 4508 Brush 5x7 mm		SG 11012 Clip		SG 11418 Side guide case
	SG 4509 Brush 5x12 mm		SG 11017 Tube adapter		SG 11419 Side guide cover
	SG 6791 Pan head screw 3.9x32		SG 11018 Tube adapter		SG 11421 Zip profile
	SG 6933 PT Countersunk screw KA25x16		SG 11025 Zip		SG 11473 Zip guide left
	SG 6936 PT Countersunk screw KA22x10		SG 11028 End cover left		SG 11474 Zip guide right
	SG 6942 Pan head screw KA30x8		SG 11029 End cover right		SG 11475 Side guide end cover left
	SG 10668 PVC strip 10 mm		SG 11030 Cover		SG 11476 Side guide end cover right
	SG 10731 Child safety retainer set		SG 11032 Chain drive		
	SG 10993 Bottom bar		SG 11034 Countersunk head screw 3.5x16		
	SG 10996 Box case 90 mm		SG 11035 Countersunk head screw 2.2x9.5		
	SG 10997 Box cover 90 mm		SG 11037 Tube ø 60 mm		
	SG 11006 End cover left 90 mm		SG 11040 Bead chain ø 4.5 mm		
	SG 11007 End cover right 90 mm		SG 11059 Pan head screw with flange M4x12		

B. OPTIONAL PARTS

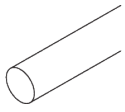

SG 4951

Bottom weight ø 8 mm



SG 11050

Spring left



SG 11051

Spring right

