

# SG 4760

---

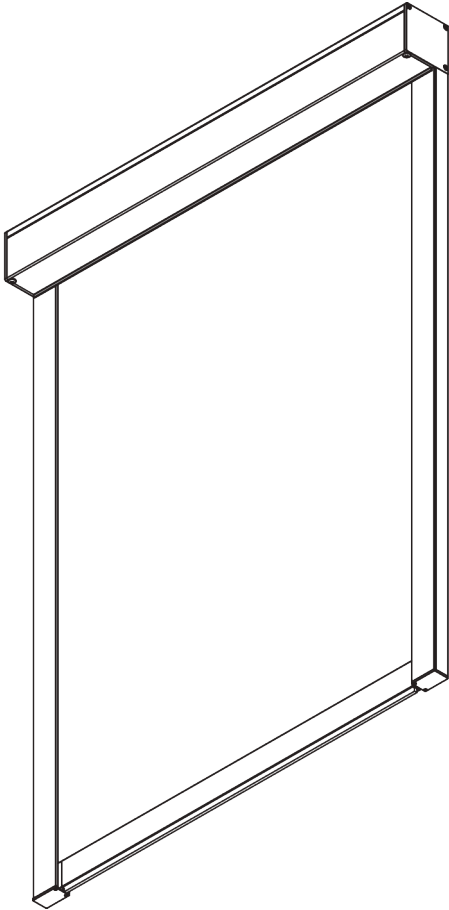
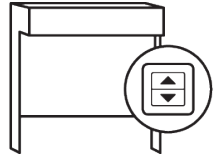

## PRODUCT INFORMATION

- **Operation:** motorised
- **Range:** S
- **Fitting:** ceiling, wall, recess
- **Colours:** white RAL 9016 or black RAL 9005, special colours possible
- **Fabrics:** refer to Silent Gliss fabric collection

### **Features:**

- Zip technology
- Quiet and fast motors
- Soft stop
- Various control options
- 40 mm side channel, pre-drilled fixing points

02/2025/V1

# SYSTEM SPECIFICATIONS

## A. SYSTEM DIMENSIONS

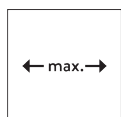

1.6 m

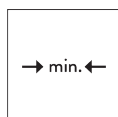

65 cm

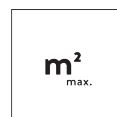

1.6 m

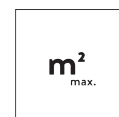

2.5 m<sup>2</sup>



2 kg

## B. PROFILE

### Profile information

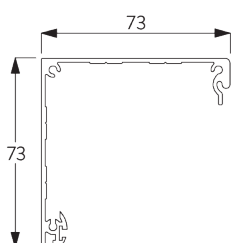

**SG 10994**  
Box case 73 mm

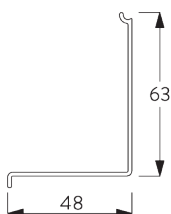

**SG 10995**  
Box cover 73 mm

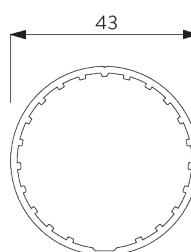

**SG 10532**  
Tube ø 43 mm

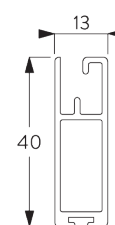

**SG 10993**  
Bottom bar

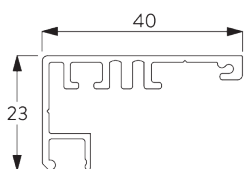

**SG 11418**  
Side guide case

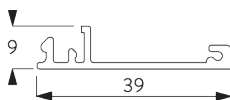

**SG 11419**  
Side guide cover

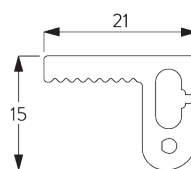

**SG 11421**  
Zip profile

## C. HOW TO MEASURE

### Inside fitting

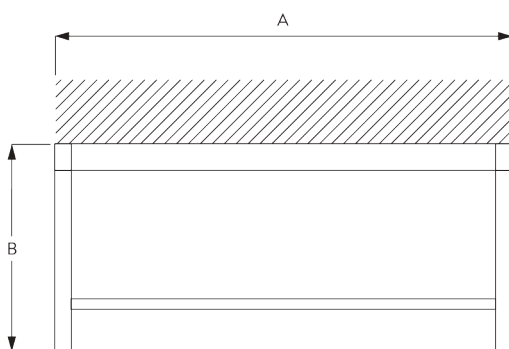

A: System width  
B: System height



## Face fitting

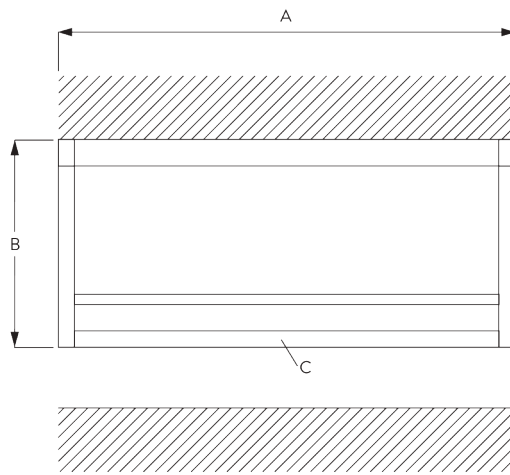

- A: System width
- B: System height
- C: Optional: end profile (SG 11418 / SG 11419)

## D. SPECIFICATION

### TEXT

#### EN

Silent Gliss SG 4760 Electrically Operated Dim-Out Roller Blind System with SG Series 20 motors. For blinds up to 1.6m wide by 1.6m drop, max 2.5sq.m. Supplied complete and made to measure comprising aluminium headbox SG 10994-5 (73 mm), side profiles SG 11418 / SG 11419 and bottom hem bar SG 10993 in white or black powder coat finish as standard.

Fabric edges retained by two component zip profile SG 11421. Operation by mains switch (not supplied) or mains switching by third party control system or SG 0450 remote control system (wireless controls at extra cost). All wiring to be strictly in accordance with Silent Gliss wiring diagrams. Fabric to be chosen from the Silent Gliss fabric range, Price Group 1R / 2R / 3R.

#### SV

Silent Gliss SG 4760 mörkläggningsrullgardin med motor serie 20. För system max 1,6 x 1,6 m, eller totalt max 2,5 m<sup>2</sup>. Levereras komplett i kundmått bestående av toppkassett i aluminium SG 10994-5 (73 mm), sidoprofiler SG 11418 / SG 11419 samt tyngdprofil SG 10993 i vit eller svart epoxy lack. Textilens kant försedd med zip profil SG 11421. Integrerad 230V motor SG 10320 / (SG 10321 radiomottagare) vänster / höger sida. Styrning via väggkontakt (ej inkluderad), via fjärrkontroll eller via externt styrsystem. All elinstallation skall följa Silent Gliss kopplingschema. Textil från Silent Gliss textilprogram i prisgrupp 1-3.

#### NO

Silent Gliss SG 4760 Mørkleggende rullegardin med motor serie 20. For system inntil 1,6 x 1,6 m, eller totalt max 2,5 m<sup>2</sup>. Levereras komplett måltilpasset. Består av toppkasse i aluminium SG 10994-5 (73 mm), sideprofiler SG 11418 / SG 11419 samt tyngdeprofil SG 10993 i hvit eller svart epoxy lakk. Sidene på tekstilet er festet med zip profil SG 11421. Integrert 230V motor SG10320 / (SG 10321 radiomottaker) venstre eller høyre side. Betjenes med veggbryter (ikke inkludert), fjernkontroll eller via eksternt styrsystem. Ved alle elektriske installasjoner skal Silent Gliss koblingskjema benyttes. Tekstiler fra Silent Gliss tekstilkolleksjon i prisgrupp 1-3.

# FITTING

## A. FITTING INFORMATION

For detailed fitting information, visit the Silent Gliss website.

**Inside fitting - fixing points**

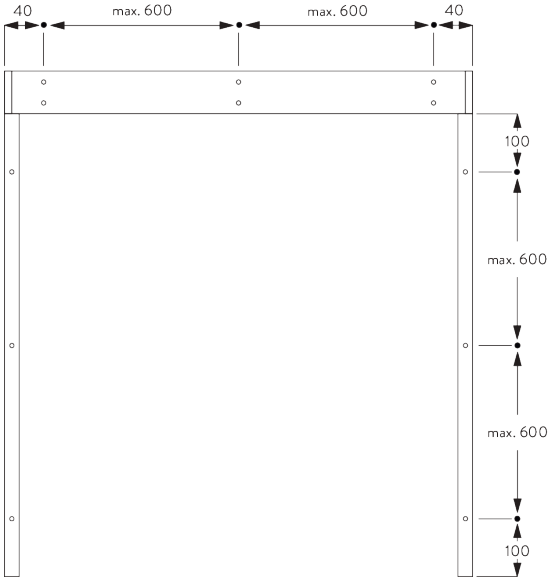

**Face fitting - fixing points**

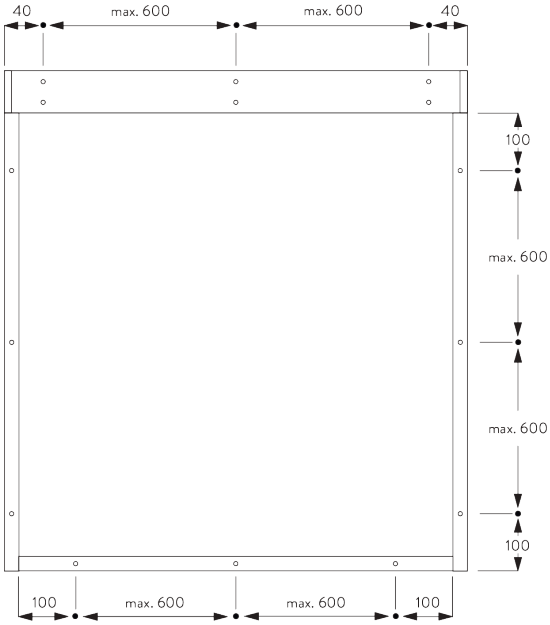

**B. CEILING FITTING**

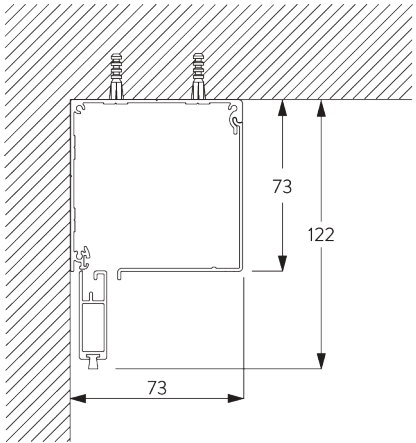

**C. WALL FITTING**

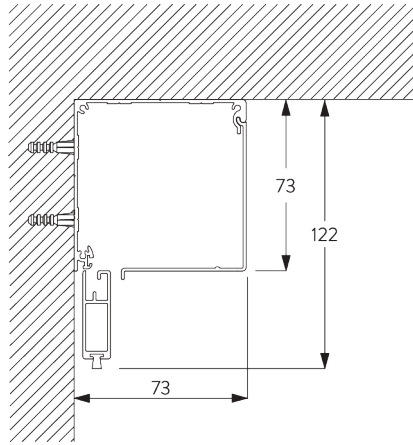

**D. RECESS FITTING**

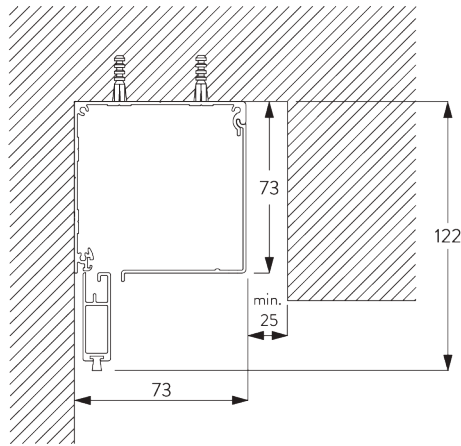

**E. SIDE PROFILES**  
**SG 11418 / SG 11419**

**Inside fitting**

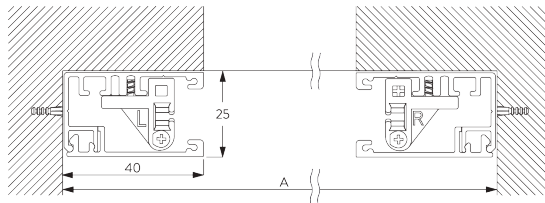

A: System width

**Face fitting**

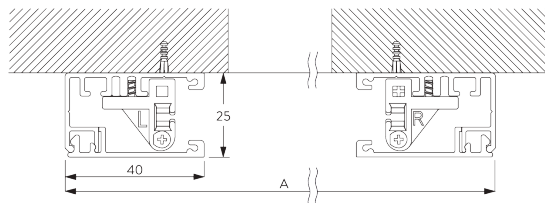

A: System width

# MOTORS & CONTROLS

## A. MOTOR FEATURES

Motors	50-Series	20-Series	20-Series	10-Series K	5-Series
	SG 11251	SG 10523	SG 10522	SG 10514	SG 10715

### Motor Features

Soft stop	•	•	•		
Electronic end-stop	•	•	•		
Electronic revolution counter (unlimited revolution)	•	•	•		
Mechanical end-stop				•	•
Mechanical revolution counter (limited revolution)				•	•
Two intermediate positions possible		•			
Bottom bar alignment	•				
Noiseless stop		•	•	•	
Parallel wiring possible without additional relays		•	•		
Disconnectable motor cable	•	•	•		
IP class	IP 30	IP 44	IP 44	IP 44	IP 44

### Control Features

Mains power control		•	•	•	•
SG Control L (built-in receiver)		•			
Smart by Silent Gliss	•				
Suitable for most major home automation systems (with suitable interface)		•	•	•	•

## B. MOTOR SPECIFICATIONS

Motors	Min. system width	Voltage	Current	Frequency	Speed	Frequency receiver
<b>50-Series (Smart by Silent Gliss)</b>						
SG 11251	65 cm	24 V DC	1.5 A	-	32 rpm	-
<b>20-Series</b>						
SG 10522 (standard)	65 cm	230 V AC	0.55 A	50 Hz	30 rpm	-
SG 10523	65 cm	230 V AC	0.55 A	50 Hz	30 rpm	868/915 MHz
<b>10-Series K</b>						
SG 10514	65 cm	230 V AC	0.52 A	50 Hz	30 rpm	-
<b>5-Series</b>						
SG 10715	65 cm	230 V AC	0.485 A	50-60 Hz	28 rpm	-

## C. OPERATING METHODS

See catalogue "controls" for details.

### Wall Switch



System can be operated by fixed wall switch.

**SG Control L**



*Various radio hand-held and wall transmitters available.*



*Silent Gliss Move App.*

**Smart by Silent Gliss**



*Open designed two-way communication system which allows to flawlessly integrate products with most major building management systems.*











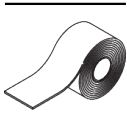

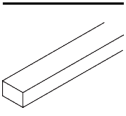
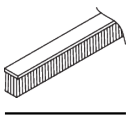
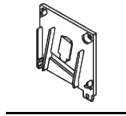
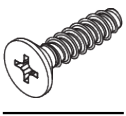
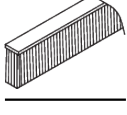
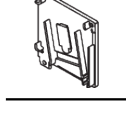
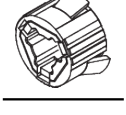
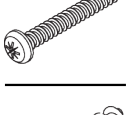
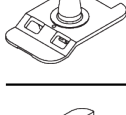
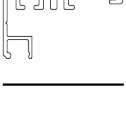
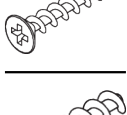
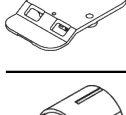
**D. WIRING**  
**DIAGRAMS**

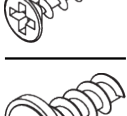
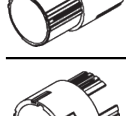
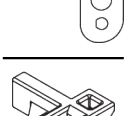
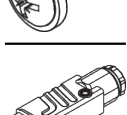

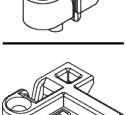
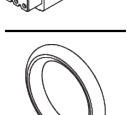
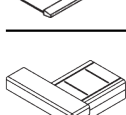
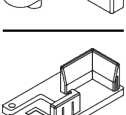
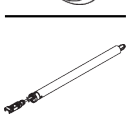
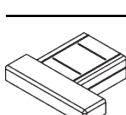
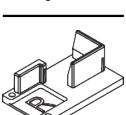
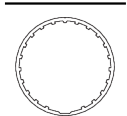
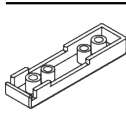
*Refer to Silent Gliss website.*

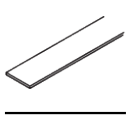
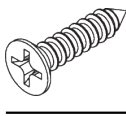
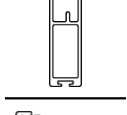
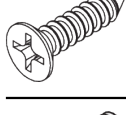









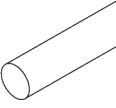
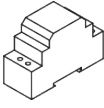
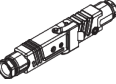
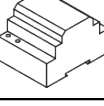
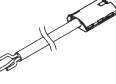
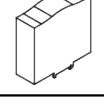

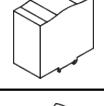

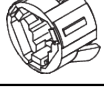
# PARTS

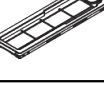
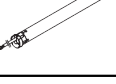
## A. STANDARD PARTS

	<b>SG 4226</b> Double tape 30 mm		<b>SG 10995</b> Box cover 73 mm		<b>SG 11060</b> Foam tape adhesive
	<b>SG 4508</b> Brush 5x7 mm		<b>SG 11004</b> End cover left 73 mm		<b>SG 11324</b> PT Screw Countersunk KA35x14
	<b>SG 4509</b> Brush 5x12 mm		<b>SG 11005</b> End cover right 73 mm		<b>SG 11354</b> Motor drive 10/20-Series
	<b>SG 6791</b> Pan head screw 3.9x32		<b>SG 11011</b> Clip		<b>SG 11418</b> Side guide case
	<b>SG 6933</b> PT Countersunk screw KA25x16		<b>SG 11013</b> Clip		<b>SG 11419</b> Side guide cover
	<b>SG 6936</b> PT Countersunk screw KA22x10		<b>SG 11014</b> Tube adapter		<b>SG 11421</b> Zip profile
	<b>SG 6942</b> Pan head screw KA30x8		<b>SG 11016</b> Tube adapter		<b>SG 11473</b> Zip guide left
	<b>SG 9917</b> Hirschmann portable socket-outlet STAK 3 N		<b>SG 11025</b> Zip		<b>SG 11474</b> Zip guide right
	<b>SG 10284</b> O-Ring		<b>SG 11028</b> End cover left		<b>SG 11475</b> Side guide end cover left
	<b>SG 10522</b> Motor 230V AC, 20-Series S 3/30		<b>SG 11029</b> End cover right		<b>SG 11476</b> Side guide end cover right
	<b>SG 10532</b> Tube ø 43 mm		<b>SG 11030</b> Cover		
	<b>SG 10668</b> PVC strip 10 mm		<b>SG 11034</b> Countersunk head screw 3.5x16		
	<b>SG 10993</b> Bottom bar		<b>SG 11035</b> Countersunk head screw 2.2x9.5		
	<b>SG 10994</b> Box case 73 mm		<b>SG 11059</b> Pan head screw with flange M4x12		

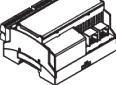

## B. OPTIONAL PARTS

	<b>SG 4951</b> Bottom weight ø 8 mm		<b>SG 11263</b> Power supply 24V DC, 2 Ampere DIN Rail
	<b>SG 9916</b> Hirschmann plug set		<b>SG 11264</b> Power supply 24V DC, 3.8 Ampere DIN Rail
	<b>SG 10293</b> Cable 230V AC, 2/3/5/10 m		<b>SG 11265</b> Power supply 24V DC, 5 Ampere DIN Rail
	<b>SG 10300</b> Radio hand held 1 channel		<b>SG 11266</b> Power supply 24V DC, 10 Ampere DIN Rail
	<b>SG 10302</b> Radio hand held 5+1 channel		<b>SG 11356</b> Motor drive 40/50-Series
	<b>SG 10303</b> Radio hand held 10+2+1 channel		<b>SG 11460</b> Cover for Hirschmann plug
	<b>SG 10514</b> Tubular motor 230V AC, 10 Series S 3/30 K		<b>SG 11480</b> Radio wall transmitter 1 channel
	<b>SG 10523</b> Motor 230V AC, 20-Series S 3/30, radio receiver		<b>SG 11490</b> Radio wall transmitter 5+1 channel
	<b>SG 10715</b> Tubular motor 230V AC, 5 Series S 6/28		
	<b>SG 10804</b> Radio hand held 15+5+1 channel		
	<b>SG 11251</b> Tubular motor 24V DC, 50-Series S 3/32		
	<b>SG 11260</b> Gateway Cedia		
	<b>SG 11261</b> Gateway KNX		
	<b>SG 11262</b> Expansion unit		





