

SG 1012

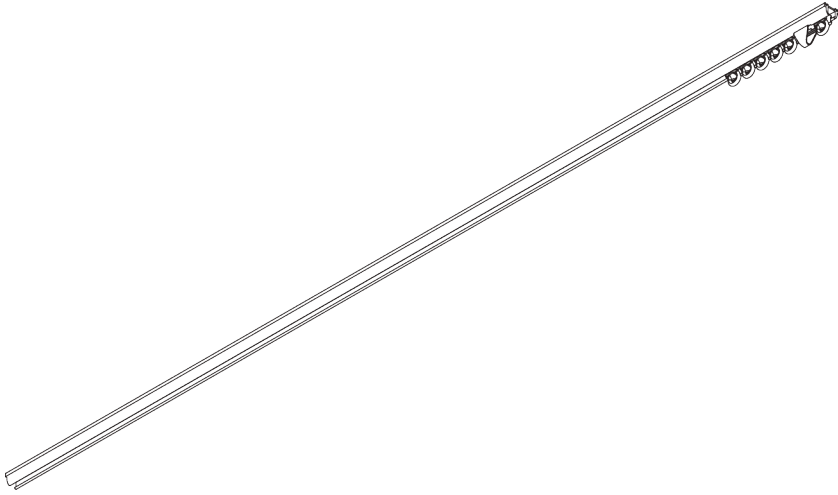

PRODUCT INFORMATION

- **Operation:** hand
- **Range:** S
- **Fitting:** recess (center SG 7550)
- **Colours:** white RAL 9016 or anodised aluminum, special colours possible
- **Fabrics:** refer to Silent Gliss fabric collection

Features:

- Pre-drilled profile
- Bendable

SYSTEM SPECIFICATIONS

A. PROFILE

Profile and bending information

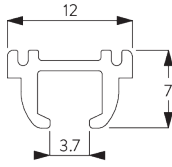

SG 1012p

Profile

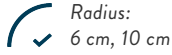

B. HOW TO MEASURE

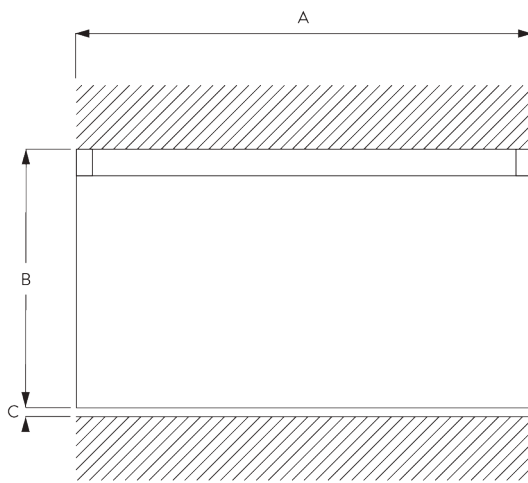

A: System width

B: System height

C: Distance between floor and fabric

C. SPECIFICATION

TEXT

EN

Silent Gliss SG 1012 Hand Drawn Curtain Track System. Comprises aluminium profile SG 1012 supplied made to measure in silver anodised or white powder coated, alternatively a specified RAL colour. SG 3533 at 14/m and 2 end covers SG 3512/ end stops SG 3070/SG 3085 Spring stops per length. Top fixed with brackets SG 3112/3121 at max. 120 mm centres. Or directly to ceiling with screws SG 3019/3025.

SV

Silent Gliss SG 1012 handdragssystem. Består av aluminiumprofil SG 1012 i specificerad längd i vitlack, alu natur eller angiven RAL färg. 14 st SG 3533 glid per meter, 2 st SG 3512 ändskydd samt 2 st SG 3070 vridstopp/SG 3085 fjäder per system. Takmonteras med fäste SG 3112/3121 c/c 120 mm. Alternativt skruvas direkt i tak m skruv SG 3019/SG 3025.

NO

Silent Gliss SG 1012 manuell gardinskinne. Består av aluminiumprofil SG 1012 i spesifisert lengde, standard i hvitlakkert eller alu natur. Kan også leveres i spesifisert RAL farge. 14 stk SG 3533 glidere pr meter, 2 stk SG 3070 vridstopp/SG 3085 fjær pr system. Takmonteres med feste SG3112/3121 c/c 120 mm. Alternativt skrues skinnen direkte i taket med skruer SG 3019/SG 3025.

DA

Silent Gliss SG 1012 håndtrukket gardinskinnesystem. Består af en aluminiumprofil SG 1012 i ønsket længde, sølvanodiseret eller hvid pulverlakering, alternativt en specificeret RAL-farve. 14 stk. SG 3533 pr. m og 2 stk. SG 3512 endelåg eller SG 3070/SG 3085 fjeder pr. længde. Loftmonteres med beslagene SG 3112/3121 med højst 120 mm afstand. Eller direkte i loftet med skruer SG3019/3025.

FITTING

A. FITTING INFORMATION

For detailed fitting information, visit the Silent Gliss website.

Fixing points

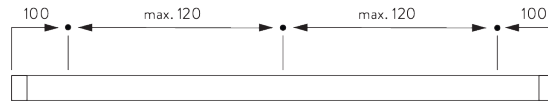

Profile Protector

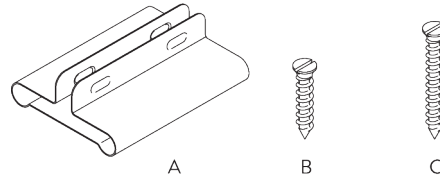

A: Profile Protector SG 7002
B: Special Screw SG 3019 / 12 mm
C: Special Screw SG 3025 / 18 mm

B. CEILING FITTING

Direct into wood

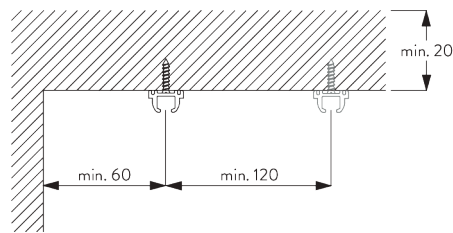

Bracket SG 3112

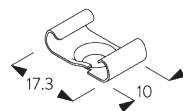
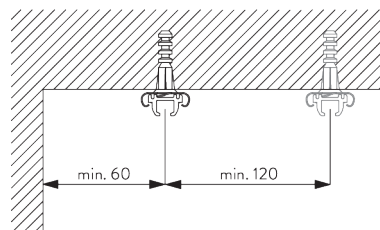

SG 3112
Bracket

Bracket SG 3121

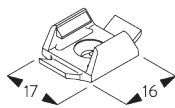
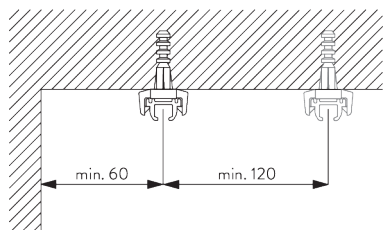

SG 3121
Bracket

PARTS

A. STANDARD PARTS

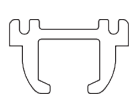

SG 1012p
Profile



SG 3019
Special screw 12 mm



SG 3070
End stop

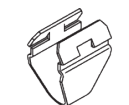

SG 3085
Spring stop



SG 3533
Glider

B. OPTIONAL PARTS

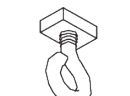

SG 3016
End stop



SG 3020
Hook

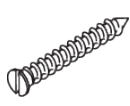

SG 3025
Special screw 18 mm



SG 3032
Spring stop

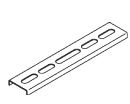

SG 3064
Connecting bridge



SG 3071
End stop



SG 3112
Bracket



SG 3511
Glider



SG 3512
End cover



SG 3534
Glider 3533 on strip



SG 3535
Glider



SG 3537
Glider

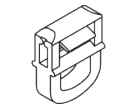

SG 3548
Glider



SG 3549
Click glider with hook



SG 3570
Glider



SG 3571
Hook

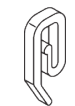

SG 3582
Hook

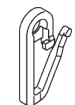

SG 3598
Eyelet



SG 3599
Hook

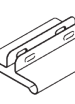

SG 7002
Profile protector

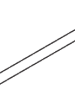

SG 10430
Draw rod 50 cm



SG 10431
Draw rod 75 cm



SG 10432
Draw rod 100 cm

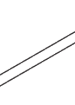

SG 10433
Draw rod 125 cm

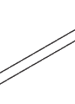

SG 10434
Draw rod 150 cm



SG 11335
End stop

