

SG 6010

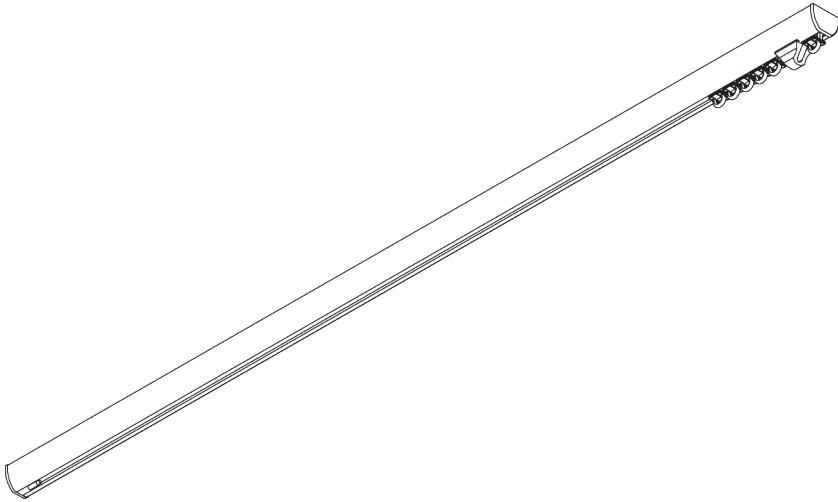

PRODUCT INFORMATION

- **Operation:** hand
- **Range:** S - M
- **Fitting:** ceiling, wall
- **Colours:** white RAL 9016, black RAL 9005 or anodised aluminum, special colours possible
- **Fabrics:** refer to Silent Gliss fabric collection

Features:

- 2-component (2C) glider technology
- Wave (2C)
- Bendable

SYSTEM SPECIFICATIONS

A. PROFILE

Profile and bending information

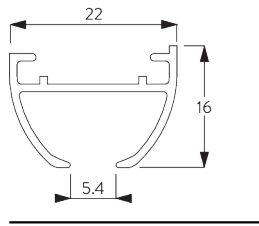

SG 6010p

Profile

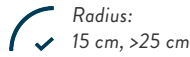

B. HOW TO MEASURE

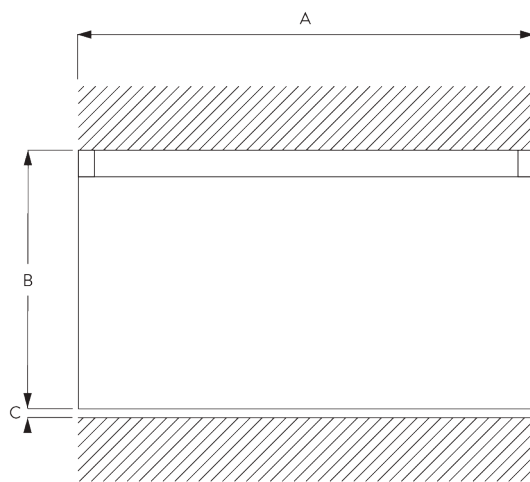

A: System width

B: System height

C: Distance between floor and fabric

C. SPECIFICATION

TEXT

EN

Silent Gliss SG 6010 Hand Drawn Curtain Track System. Comprises aluminium profile SG 6010 supplied made to measure in silver anodised or white powder coated, alternatively a specified RAL colour. SG 11300 SILENT TRACK at 14/m and 2 end covers SG 6018 and 2 end stops SG 6065 per length. 2 Top fix with SG 3825. Wall fix with SG 3825 w. SG Smart Fix at max. 500mm centres. Silent Gliss Wave option is available.

SV

Silent Gliss SG 6010 handdragssystem. Består av aluminiumprofil SG 6010 i specificerad längd i vitlack, alu natur eller angiven RAL färg. 14 st SG 11300 SILENT TRACK glid per meter, 2 st SG 6018 ändskydd samt 2 st SG 6065 vridstopp per system. Takmonteras med fäste SG 3825 c/c 500 mm. Vägmontering med SG 3825 med Smart Fix c/c 500 mm. Kan användas med system Wave.

NO

Silent Gliss SG 6010 Manuell gardinskinne. Består av aluminiumprofil SG 6010 i spesifisert lengde, standard i hvitlakkert eller alu natur. Kan også leveres i spesifisert RAL farge. 14 stk SG 11300 SILENT TRACK glidere pr. m og 2 stk SG 6018 endeløkk og 2 stk SG6065 stopper pr system. Veggmontering med SG 3825 med Smart Fix c/c 500mm. Kan kombineres med Wave.

DA

Silent Gliss SG 6010 håndtrukket gardinskinnesystem. Består af en aluminiumprofil SG 6010 i ønsket længde, sølvanodiseret eller hvid pulverlakering, alternativt en specificeret RAL-farve. 14 stk. SG 11300 SILENT TRACK pr. m og 2 stk. SG 6018 endelæg samt 2 stk. SG 6065 endestop pr. længde. Loftmonteres med SG 3825. Vægmonteres med SG 3825 med SG Smart Fix med en afstand på højst 500 mm. Kan bruges med Silent Gliss Wave.

FITTING

A. FITTING INFORMATION

For detailed fitting information, visit the Silent Gliss website.

Fixing points

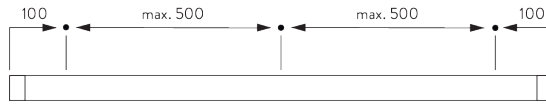

B. CEILING FITTING

Clamp SG 3825

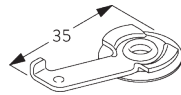
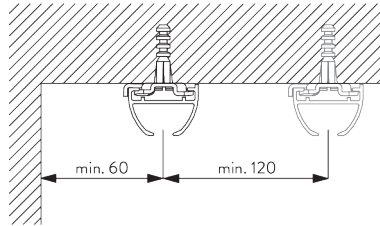

SG 3825
Clamp

Bracket SG 3832

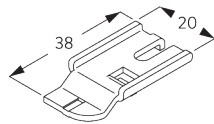
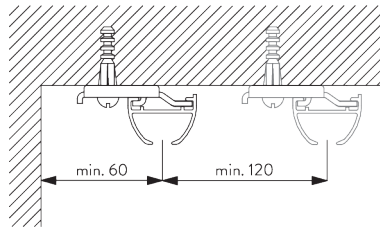

SG 3832
Bracket

C. WALL FITTING

Smart Fix

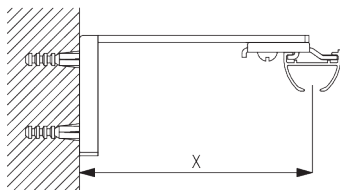

Smart Fix SG 11200 - SG 11205 and bracket SG 3832:
Screw SG 10492 (M4x8) needed.

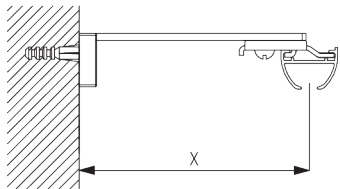

Square Smart Fix SG 11210 - SG 11215 and bracket SG 3832:
Screw SG 10492 (M4x8) needed.

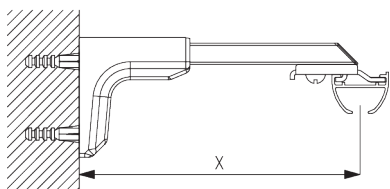

Universal Smart Fix SG 11154 - SG 11156 and bracket SG 3832:
Screw SG 10407 (M4x10) needed.

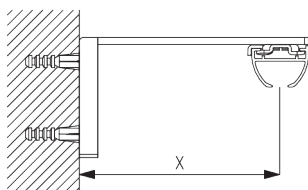

Smart Fix SG 11200 - SG 11205 and clamp SG 3825:
Screw SG 10074 (M4x8) needed.

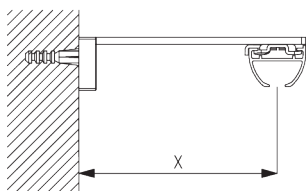

Square Smart Fix SG 11210 - SG 11215 and clamp SG 3825:
Screw SG 10074 (M4x8) needed.

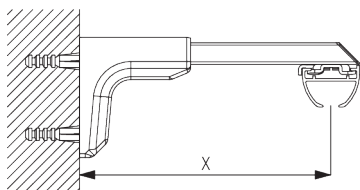

Universal Smart Fix SG 11154 - SG 11156 and clamp SG 3825:
Screw SG 11158 (M4x12) needed.

Smart Fix	X mm (SG 3832)	X mm (SG 3825)
SG 11200 / SG 11210	70	52
SG 11201 / SG 11211	90	72
SG 11202 / SG 11212	110	92
SG 11203 / SG 11213	130	112
SG 11204 / SG 11214	160	142
SG 11205 / SG 11215	210	192
SG 11154	120-148	102-130
SG 11155	150-178	132-160
SG 11156	200-228	182-210

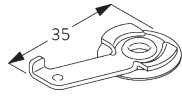

SG 3825
Clamp

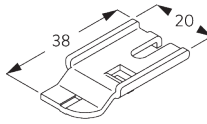

SG 3832
Bracket



SG 10407
Pan head screw M4x10



SG 10492
Pan head screw M4x8



SG 11158
Countersunk head screw
M4x12

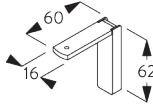

SG 11200
Smart Fix 60 mm

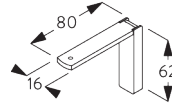

SG 11201
Smart Fix 80 mm

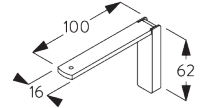

SG 11202
Smart Fix 100 mm

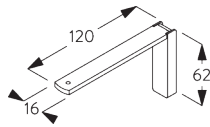

SG 11203
Smart Fix 120 mm

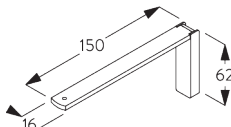

SG 11204
Smart Fix 150 mm

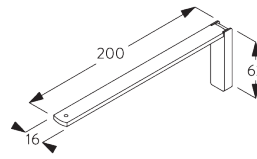

SG 11205
Smart Fix 200 mm

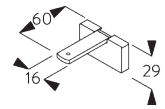

SG 11210
Square Smart Fix 60 mm

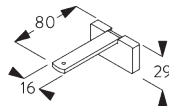

SG 11211
Square Smart Fix 80 mm

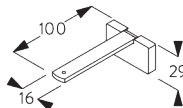

SG 11212
Square Smart Fix 100 mm

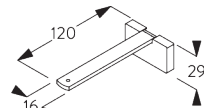

SG 11213
Square Smart Fix 120 mm

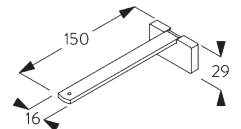

SG 11214
Square Smart Fix 150 mm

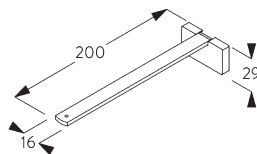

SG 11215
Square Smart Fix 200 mm

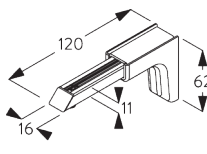

SG 11154
Universal Smart Fix 120 mm

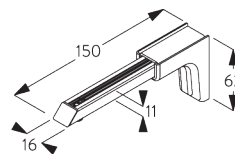

SG 11155
Universal Smart Fix 150 mm

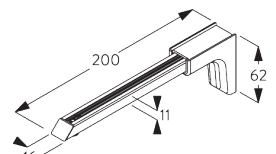

SG 11156
Universal Smart Fix 200 mm

SYSTEM OPTIONS

A. WAVE

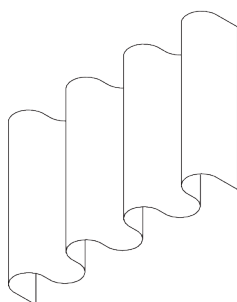

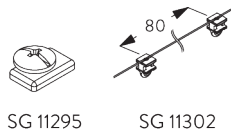

SG 11295

SG 11302

Standard components:

- SG 11295 End stop
- SG 11302 Wave 2C glider cord 80 mm

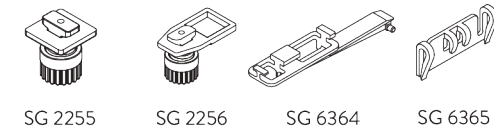

SG 2255

SG 2256

SG 6364

SG 6365

Optional components (min. radius: >25 cm):

- SG 2255 Brake
- SG 2256 Brake
- SG 6364 Wave extension
- SG 6365 Wave hanger
- SG 6366 Wave carrier for draw rod
- SG 10430-34 Draw rod
- SG 11303 Wave 2C glider cord 60 mm



SG 6366

SG 10430-34

SG 11303

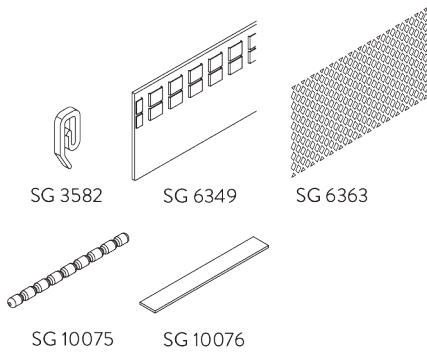

SG 3582

SG 6349

SG 6363

SG 10075

SG 10076

Curtain components:

- SG 3582 Hook
- SG 6349 Wave curtain tape
- SG 6363 Wave top hemming tape
- SG 10075 Lead weight 50 gr/m
- SG 10076 Fabric weight

Wave stack depth - 2C glider cord (standard components)

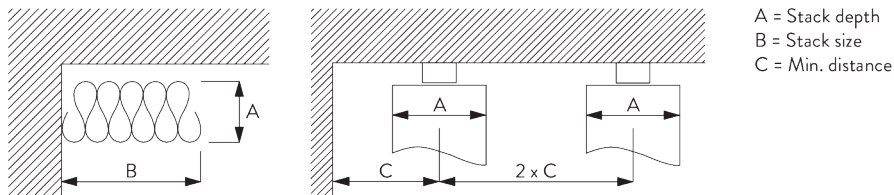







2C Glider cord SG 11302	Pockets between hooks	Approx. curtain fullness	Stack depth A	Stack size B*	Min distance C
80	6	~2.1	140	180 per metre of track	90
80	7	~2.3	160	180 per metre of track	100

2C Glider cord SG 11303	Pockets between hooks	Approx. curtain fullness	Stack depth A	Stack size B*	Min distance C
60	4	~2.1	100	230 per metre of track	70
60	5	~2.3	120	230 per metre of track	80



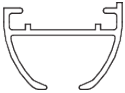
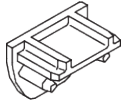

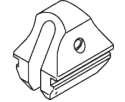





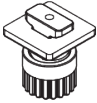
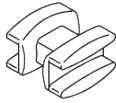
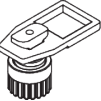







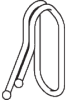
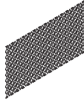

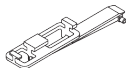
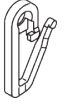
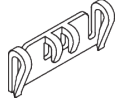
*Stack size B when using optional extension arm increases by 150 mm per curtain stack!

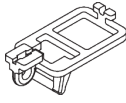
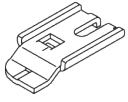
PARTS

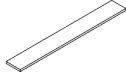
A. STANDARD PARTS

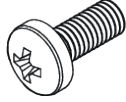
	SG 3599 Hook
	SG 3825 Clamp
	SG 6010p Profile
	SG 6018 End cover
	SG 6065 End stop
	SG 6086 Spring stop
	SG 11300 2C glider

B. OPTIONAL PARTS

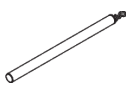
	SG 2255 Brake		SG 6082 Glider
	SG 2256 Brake		SG 6098 Roller
	SG 3012 Hook		SG 6240 Roller
	SG 3020 Hook		SG 6283 Roller
	SG 3571 Hook		SG 6349 Wave curtain tape
	SG 3581 Hook		SG 6363 Wave top hemming tape
	SG 3582 Hook		SG 6364 Wave extension
	SG 3598 Eyelet		SG 6365 Wave hanger
	SG 3802 Connection bridge		SG 6366 Wave carrier for draw rod
	SG 3832 Bracket		SG 10075 Lead weight 50 g/m
	SG 6005 Hook		SG 10076 Fabric weight
	SG 6053 Spring stop		SG 10407 Pan head screw M4x10
	SG 6057 Glider		SG 10430 Draw rod 50 cm
	SG 6064 End stop		SG 10431 Draw rod 75 cm

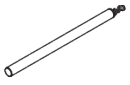

SG 10432
Draw rod 100 cm

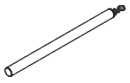

SG 10433
Draw rod 125 cm

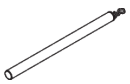

SG 10434
Draw rod 150 cm

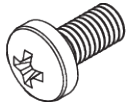

SG 10492
Pan head screw M4x8

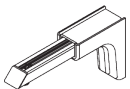

SG 11154
Universal Smart Fix 120 mm

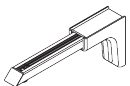

SG 11155
Universal Smart Fix 150 mm

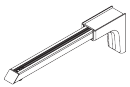

SG 11156
Universal Smart Fix 200 mm

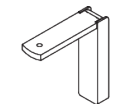

SG 11200
Smart Fix 60 mm

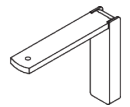

SG 11201
Smart Fix 80 mm

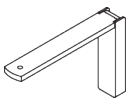

SG 11202
Smart Fix 100 mm

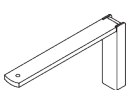

SG 11203
Smart Fix 120 mm

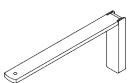

SG 11204
Smart Fix 150 mm

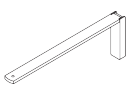

SG 11205
Smart Fix 200 mm

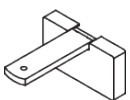

SG 11210
Square Smart Fix 60 mm

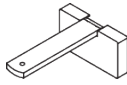

SG 11211
Square Smart Fix 80 mm

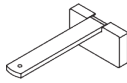

SG 11212
Square Smart Fix 100 mm

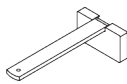

SG 11213
Square Smart Fix 120 mm

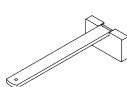

SG 11214
Square Smart Fix 150 mm

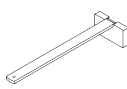

SG 11215
Square Smart Fix 200 mm



SG 11295
End stop



SG 11301
2C glider on strip

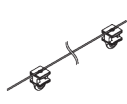

SG 11302
Wave 2C glider cord 80 mm

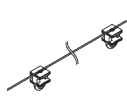

SG 11303
Wave 2C glider cord 60 mm

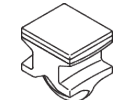

SG 11305
2C glider for direct sewing