

SG 6293

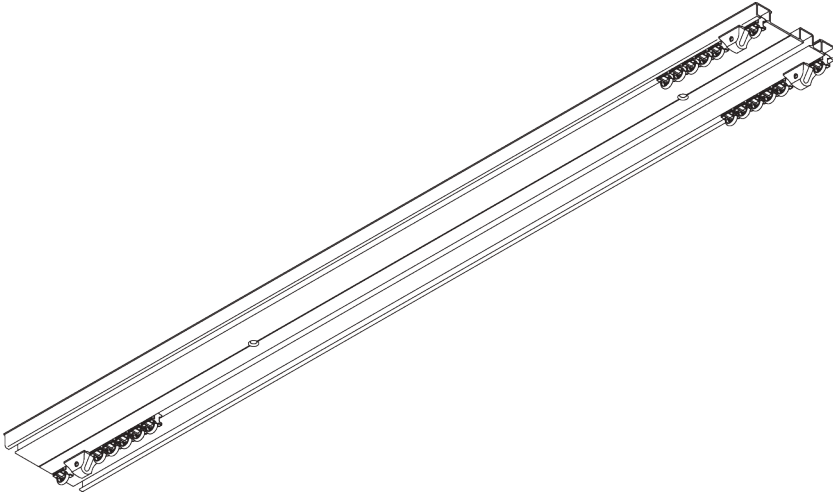

PRODUCT INFORMATION

- **Operation:** hand
- **Range:** M - L
- **Fitting:** ceiling
- **Colours:** white RAL 9016 or anodised aluminum, special colours possible
- **Fabrics:** refer to Silent Gliss fabric collection

Features:

- 2-component (2C) glider technology
- Pre-drilled profile

SYSTEM SPECIFICATIONS

A. PROFILE

Profile information

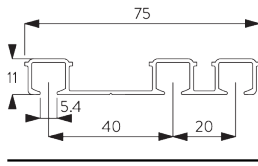

SG 6293p

Profile

B. HOW TO MEASURE

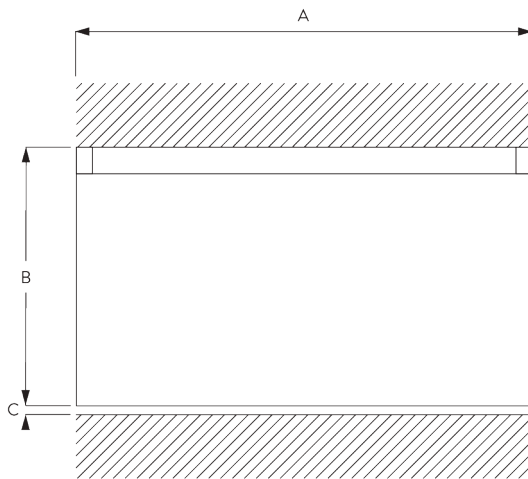

A: System width

B: System height

C: Distance between floor and fabric

C. SPECIFICATION

TEXT

EN

Silent Gliss SG 6293 Hand Drawn Curtain Track System for recessed fitting. Comprises aluminium profile SG 6293 supplied made to measure in silver anodised or white powder coated, alternatively a specified RAL colour. SG 11300 SILENT TRACK at 14/m/track and 6 SG 6065 End stops / SG 6086 Spring Stops per length. Top fix to ceiling with screws at max. 400 mm centres.

SV

Silent Gliss SG 6293 handdragssystem för infällning. Består av aluminiumprofil SG 6293 i specificerad längd i vitlack, alu natur eller angiven RAL färg. 14 st SG 11300 SILENT TRACK glid per meter/spår samt 6 st SG 6065 vridstopp / SG 6086 fjäder per system. Takmonteras med skruv c/c 400 mm.

NO

Silent Gliss SG 6293 Manuell gardinskinne for innfelling. Består av aluminiumprofil SG 6293 i spesifisert lengde, standard i hvitlakkert eller alu natur. Kan også leveres i spesifisert RAL farge. 14 stk SG 11300 SILENT TRACK glidere pr meter/spor, 6 stk SG 6065 vristopp/SG 6086 fjær pr system. Takmonteres med skruer c/c 400 mm.

DA

Silent Gliss SG 6293 håndtrukket gardinskinnesystem til indfældning. Består af en aluminiumprofil SG 6293 i ønsket længde, sølvanodiseret eller hvid pulverlakering, alternativt en specificeret RAL-farve. 14 stk. SG 11300 SILENT TRACK pr. m/skinne og 6 stk. SG 6065 endestop eller SG 6086 fjeder pr. længde. Fastgøres i loftet med skruer med højst 400 mm afstand.

FITTING

A. FITTING INFORMATION

For detailed fitting information, visit the *Silent Gliss* website.

Fixing points

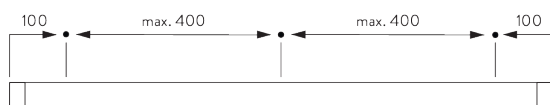



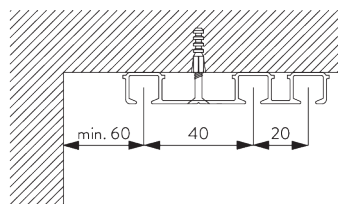

B. CEILING FITTING

Direct fitting





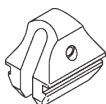







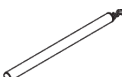
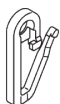

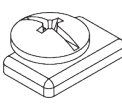
PARTS

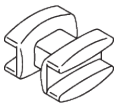
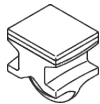
A. STANDARD PARTS

	SG 3599 Hook
	SG 6065 End stop
	SG 6086 Spring stop
	SG 6293p Profile
	SG 11300 2C glider

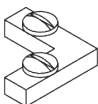
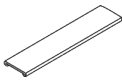
B. OPTIONAL PARTS

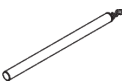
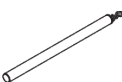
	SG 3012 Hook		SG 10432 Draw rod 100 cm
	SG 3581 Hook		SG 10433 Draw rod 125 cm
	SG 3598 Eyelet		SG 10434 Draw rod 150 cm
	SG 6053 Spring stop		SG 11295 End stop
	SG 6057 Glider		SG 11301 2C glider on strip
	SG 6082 Glider		SG 11305 2C glider for direct sewing
	SG 6094 Roller		
	SG 6098 Roller		
	SG 6240 Roller		
	SG 6246 Corner connection		
	SG 6269 Connection bridge		
	SG 6283 Roller		
	SG 10430 Draw rod 50 cm		
	SG 10431 Draw rod 75 cm		