

SG 6380

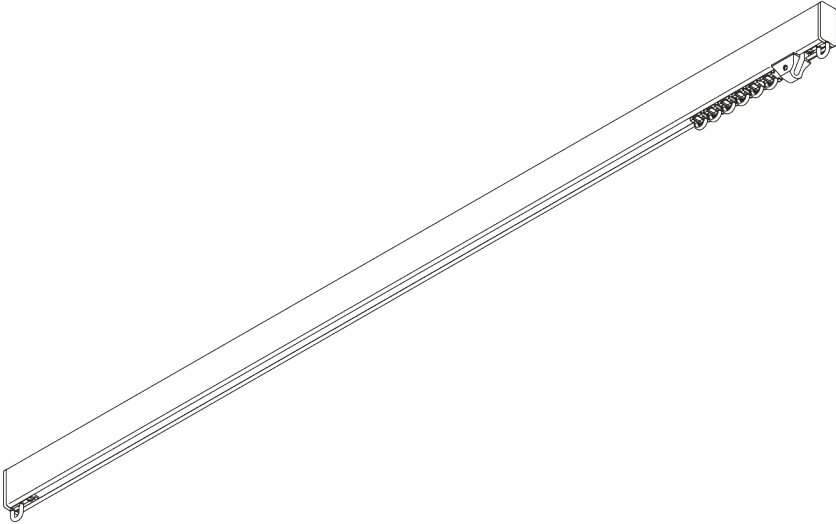

PRODUCT INFORMATION

- **Operation:** hand
- **Range:** M - L
- **Fitting:** ceiling, wall
- **Colours:** white RAL 9016 or anodised aluminum, special colours possible
- **Fabrics:** refer to Silent Gliss fabric collection

Features:

- 2-component (2C) glider technology
- Wave (2C)
- Bendable

SYSTEM SPECIFICATIONS

A. PROFILE

Profile and bending information

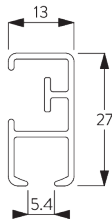

SG 6380p

Profile

Radius:
10 cm, >25 cm

B. HOW TO MEASURE

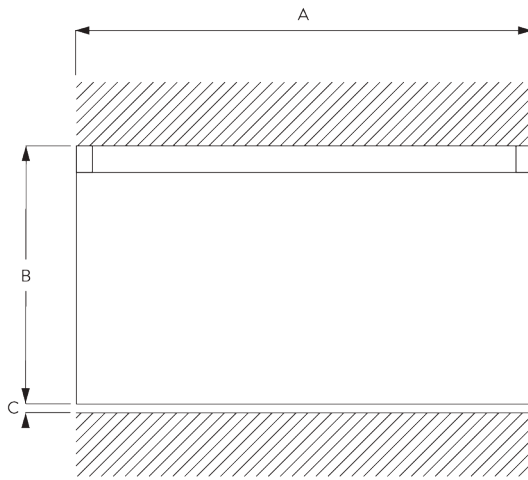

A: System width

B: System height

C: Distance between floor and fabric

C. SPECIFICATION TEXT

EN

Silent Gliss SG 6380 Hand Drawn Curtain Track System. Comprises aluminium profile SG 6380 supplied made to measure in silver anodised or white powder coated, alternatively a specified RAL colour. SG 11130 at 14/m and 2 end covers SG 6381. Top fixed with brackets SG 3603 at max. 600 mm centres / wall fix SG Smart Fix at max. 600 mm centres. Silent Gliss Wave option is available.

SV

Silent Gliss SG 6380 handdragssystem. Består av aluminiumprofil SG 6380 i specificerad längd i vitlack, alu natur eller angiven RAL färg. 14 st SG 11300 SILENT TRACK glid per meter, 2 st SG 6381 ändskydd per system. Takmonteras med fäste SG 3603 c/c 600 mm. Vägghängning med SG 3603 och Smart Fix c/c 600 mm. Kan användas med system Wave.

NO

Silent Gliss SG 6380 Manuell gardinskinne. Består av aluminiumprofil SG 6380 i spesifisert lengde, standard i hvitlakkert eller alu natur. Kan også leveres i spesifisert RAL farge. 14 stk SG 11300 SILENT TRACK glidere pr meter, 2 stk SG 6381 endeløkk pr system. Takmonteres med feste 3603 c/c 600 mm. Veggmontering med SG 3603 og smart Fix c/c 600 mm. Kan benyttes med Wave system.

DA

Silent Gliss SG 6380 håndtrukket gardinskinnesystem. Består af en aluminiumprofil SG 6380 i ønsket længde, sølvanodiseret eller hvid pulverlakering, alternativt en specificeret RAL-farve. 14 stk. SG 11130 pr. m og 2 stk. SG 6381 endelæg. Loftmonteres med beslagene SG 3603 med højst 600 mm afstand. Vægmonteres med SG Smart Fix med højst 600 mm afstand Kan bruges med Silent Gliss Wave.

FITTING

A. FITTING INFORMATION

For detailed fitting information, visit the Silent Gliss website.

Fixing points

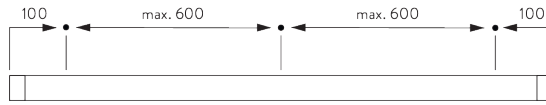

B. CEILING FITTING

Bracket SG 3603

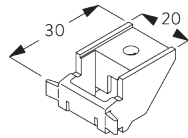
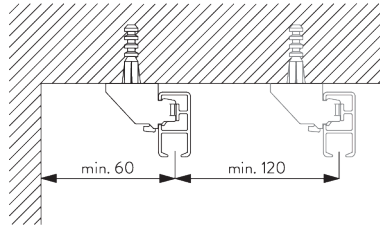

SG 3603
Bracket

C. WALL FITTING

Smart Fix

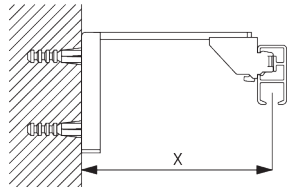

Smart Fix SG 11200 - SG 11205 and bracket SG 3603:
Screw SG 10492 (M4x8) needed.

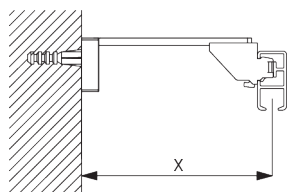

Square Smart Fix SG 11210 - SG 11215 and bracket SG 3603:
Screw SG 10492 (M4x8) needed.

Smart Fix	X mm
SG 11200 / SG 11210	72
SG 11201 / SG 11211	92
SG 11202 / SG 11212	112
SG 11203 / SG 11213	132
SG 11204 / SG 11214	162
SG 11205 / SG 11215	212
SG 11154	122-150
SG 11155	152-180
SG 11156	202-230

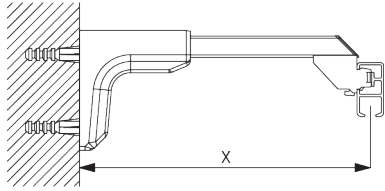

Universal Smart Fix SG 11154 - SG 11156 and bracket SG 3603:

Screw SG 10277 (M4x12) needed.

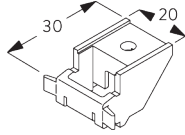

SG 3603

Bracket



SG 10277

Pan head screw M4x12



SG 10492

Pan head screw M4x8

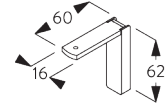

SG 11200

Smart Fix 60 mm

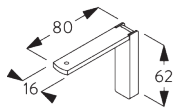

SG 11201

Smart Fix 80 mm

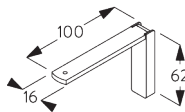

SG 11202

Smart Fix 100 mm

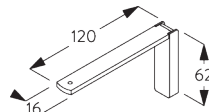

SG 11203

Smart Fix 120 mm

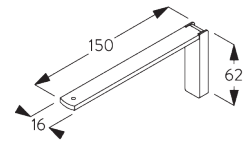

SG 11204

Smart Fix 150 mm

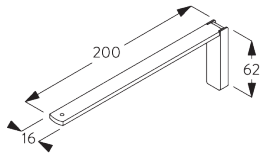

SG 11205

Smart Fix 200 mm

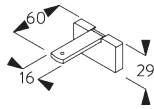

SG 11210

Square Smart Fix 60 mm

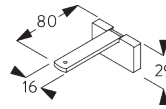

SG 11211

Square Smart Fix 80 mm

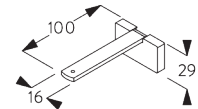

SG 11212

Square Smart Fix 100 mm

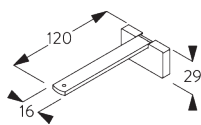

SG 11213

Square Smart Fix 120 mm

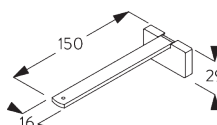

SG 11214

Square Smart Fix 150 mm

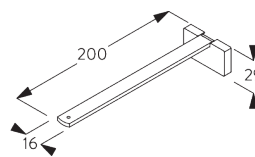

SG 11215

Square Smart Fix 200 mm

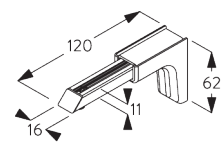

SG 11154

Universal Smart Fix 120 mm

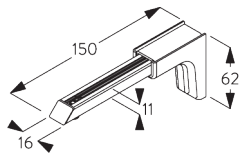

SG 11155

Universal Smart Fix 150 mm

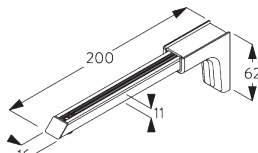

SG 11156

Universal Smart Fix 200 mm

**Universal Brackets
SG 3630, SG 3655,
SG 3660**

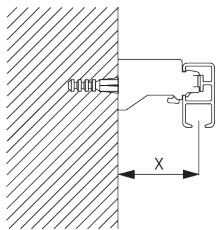

Bracket	X mm
SG 3630	35
SG 3655	50
SG 3660	65

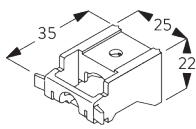

SG 3630
Bracket 35 mm

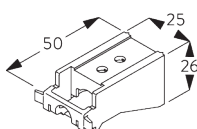

SG 3655
Bracket 50 mm

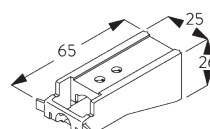

SG 3660
Bracket 65 mm

SYSTEM OPTIONS

A. WAVE

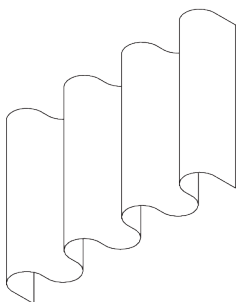

SG 11295

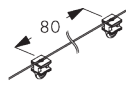

SG 11302

Standard components:

- SG 11295 End stop
- SG 11302 Wave 2C glider cord 80 mm



SG 2255



SG 2256

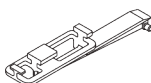

SG 6364



SG 6365

Optional components (min. radius >25 cm):

- SG 2255 Brake
- SG 2256 Brake
- SG 6364 Wave extension
- SG 6365 Wave hanger
- SG 6366 Wave carrier for draw rod
- SG 10430-34 Draw rod
- SG 11303 Wave 2C glider cord 60 mm

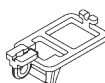

SG 6366

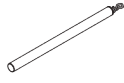

SG 10430-34

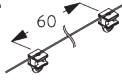

SG 11303

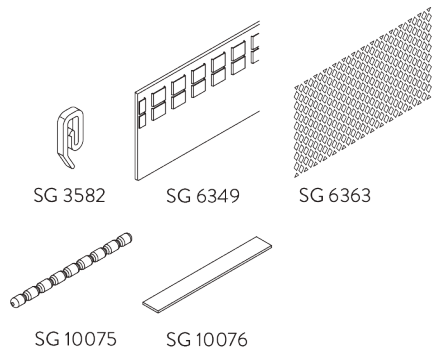

Curtain components:

- SG 3582 Hook
- SG 6349 Wave curtain tape
- SG 6363 Wave top hemming tape
- SG 10075 Lead weight 50 gr/m
- SG 10076 Fabric weight

Wave stack depth - 2C glider cord (standard components)

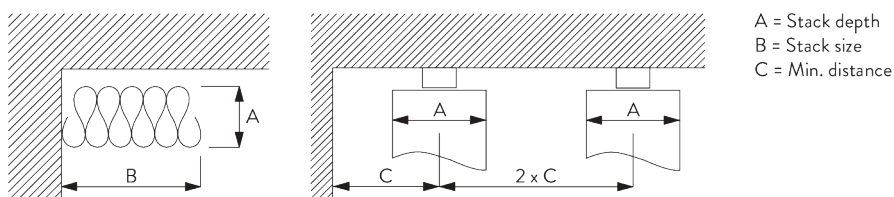

A = Stack depth
 B = Stack size
 C = Min. distance







2C Glider cord SG 11302	Pockets between hooks	Approx. curtain fullness	Stack depth A	Stack size B*	Min distance C
80	6	~2.1	140	180 per metre of track	90
80	7	~2.3	160	180 per metre of track	100

2C Glider cord SG 11303	Pockets between hooks	Approx. curtain fullness	Stack depth A	Stack size B*	Min distance C
60	4	~2.1	100	230 per metre of track	70
60	5	~2.3	120	230 per metre of track	80

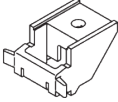



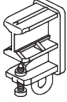





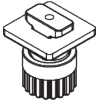

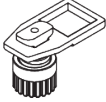



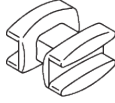

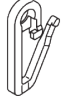

*Stack size B when using optional extension arm increases by 150 mm per curtain stack!

PARTS

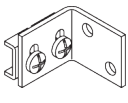
A. STANDARD PARTS

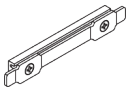
	SG 3599 Hook
	SG 3603 Bracket
	SG 6065 End stop
	SG 6086 Spring stop
	SG 6380p Profile
	SG 6381 End cover
	SG 11300 2C glider

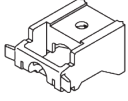
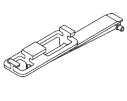
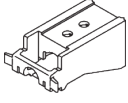
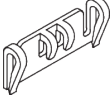
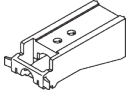
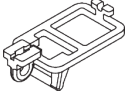
B. OPTIONAL PARTS

	SG 2255 Brake		SG 6005 Hook
	SG 2256 Brake		SG 6053 Spring stop
	SG 3012 Hook		SG 6057 Glider
	SG 3555 Hook		SG 6082 Glider
	SG 3571 Hook		SG 6094 Roller
	SG 3581 Hook		SG 6098 Roller
	SG 3582 Hook		SG 6240 Roller
	SG 3598 Eyelet		SG 6283 Roller
	SG 3618 Wall bracket		SG 6349 Wave curtain tape
	SG 3620 Connection bridge		SG 6363 Wave top hemming tape
	SG 3630 Bracket 35 mm		SG 6364 Wave extension
	SG 3655 Bracket 50 mm		SG 6365 Wave hanger
	SG 3660 Bracket 65 mm		SG 6366 Wave carrier for draw rod
	SG 6004 Eyelet		SG 10075 Lead weight 50 g/m

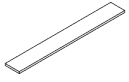

SG 10076

Fabric weight

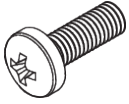

SG 10277

Pan head screw M4x12

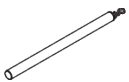

SG 10430

Draw rod 50 cm

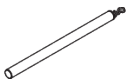

SG 10431

Draw rod 75 cm

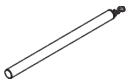

SG 10432

Draw rod 100 cm

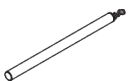

SG 10433

Draw rod 125 cm

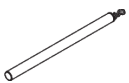

SG 10434

Draw rod 150 cm



SG 10492

Pan head screw M4x8

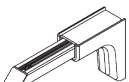

SG 11154

Universal Smart Fix 120 mm

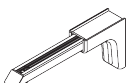

SG 11155

Universal Smart Fix 150 mm

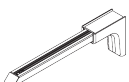

SG 11156

Universal Smart Fix 200 mm

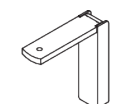

SG 11200

Smart Fix 60 mm

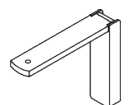

SG 11201

Smart Fix 80 mm

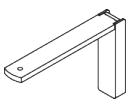

SG 11202

Smart Fix 100 mm

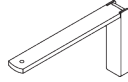

SG 11203

Smart Fix 120 mm



SG 11204

Smart Fix 150 mm

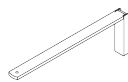

SG 11205

Smart Fix 200 mm

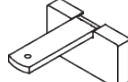

SG 11210

Square Smart Fix 60 mm

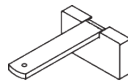

SG 11211

Square Smart Fix 80 mm

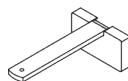

SG 11212

Square Smart Fix 100 mm

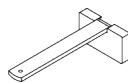

SG 11213

Square Smart Fix 120 mm

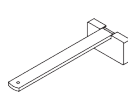

SG 11214

Square Smart Fix 150 mm

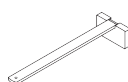

SG 11215

Square Smart Fix 200 mm



SG 11295

End stop



SG 11301

2C glider on strip

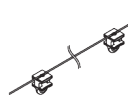

SG 11302

Wave 2C glider cord 80 mm

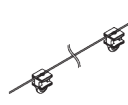

SG 11303

Wave 2C glider cord 60 mm

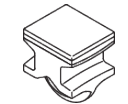

SG 11305

2C glider for direct sewing