

# HAND OPERATED CURTAIN TRACK SYSTEMS

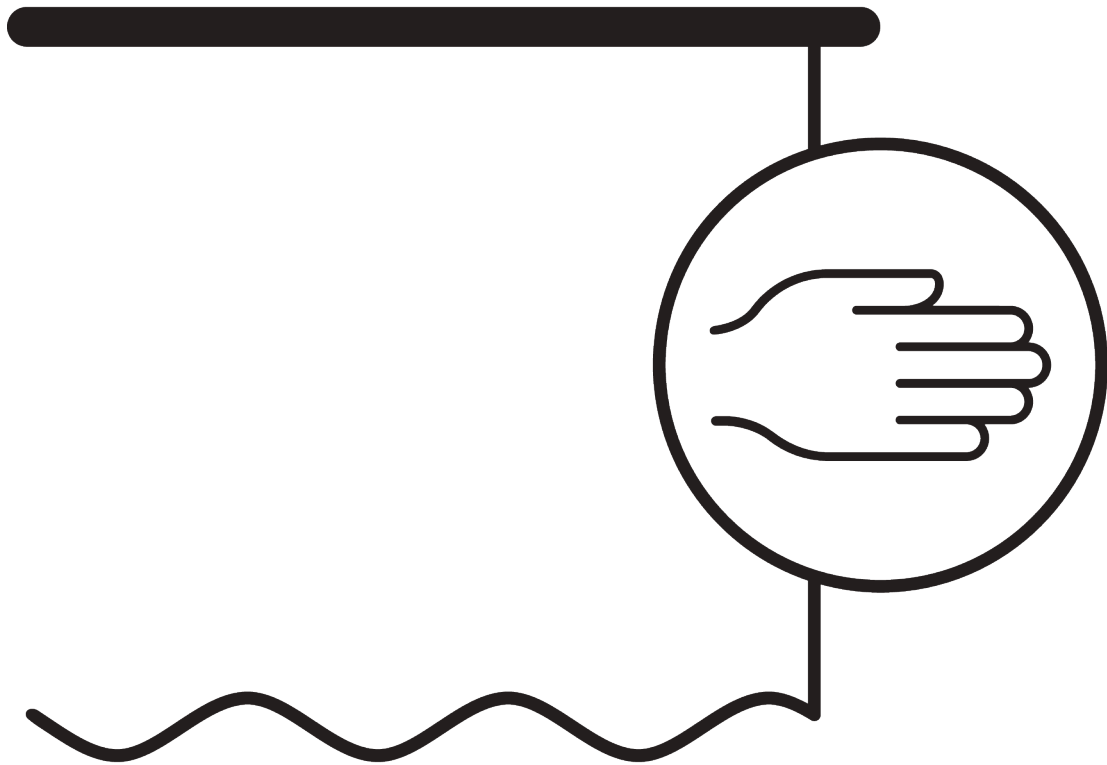

# GENERAL NOTES

## **Dimensions**

- Measurements are in mm except where indicated.
- Max. kg relates to fabric incl. accessories.
- Stack size depends on curtain make-up and fabric thickness.
- Distance between gliders max. 80 mm / distance between rollers max. 100 mm.
- Recommended distance floor / fabric: 20 mm.
- In order to determine system height (B), the smallest room height must be taken into account.







































## **Fitting**















- Installation by qualified fitter only.
- Number of brackets and fitting positions / fixing points vary depending on fitting surface, system weight, fabric make-up, screw / fixing type and obstacles.
- Qualified fitter must use appropriate screws / fixings for each situation.
- Profile lip if applicable to be installed to room side.

## **Child Safety**

- All relevant Silent Gliss systems correspond to child safety EN 13120.
- All parties involved must comply with EN 13120.

# APPLICATION CHART

<u>PAGE</u>	<u>SYSTEM</u>	<u>OPERATION</u>	<u>DIMENSION</u>	<u>DESIGN</u>	<u>WAVE</u>	<b>kg</b> <sub>max.</sub>
5	<b>SG 1011</b>		S			
9	<b>SG 1012</b>		S			
15	<b>SG 1015</b>		S			
21	<b>SG 1020</b>		S			10 kg
27	<b>SG 1060</b>		S			
31	<b>SG 1070</b>		S			
35	<b>SG 1080</b>		S			
43	<b>SG 1090</b>		S			
51	<b>SG 3600</b>					10 kg
57	<b>SG 6010</b>		S - M			
65	<b>SG 6243</b>		S - M			
71	<b>SG 6250</b>		S - M			
77	<b>SG 6293</b>		M - L			
81	<b>SG 6380</b>		M - L			
89	<b>SG 6465</b>		S - M			
97	<b>SG 6475</b>		S - M			

<u>PAGE</u>	<u>SYSTEM</u>	<u>OPERATION</u>	<u>DIMENSION</u>	<u>DESIGN</u>	<u>WAVE</u>	kg <sub>max.</sub>
103	<b>SG 6815</b>		S - M			
111	<b>SG 6820</b>		S - M			10 kg
119	<b>SG 6840</b>		M - L			
129	<b>SG 6870</b>		M - L			
139	<b>SG 6970</b>		M - L			

# SG 1011

---

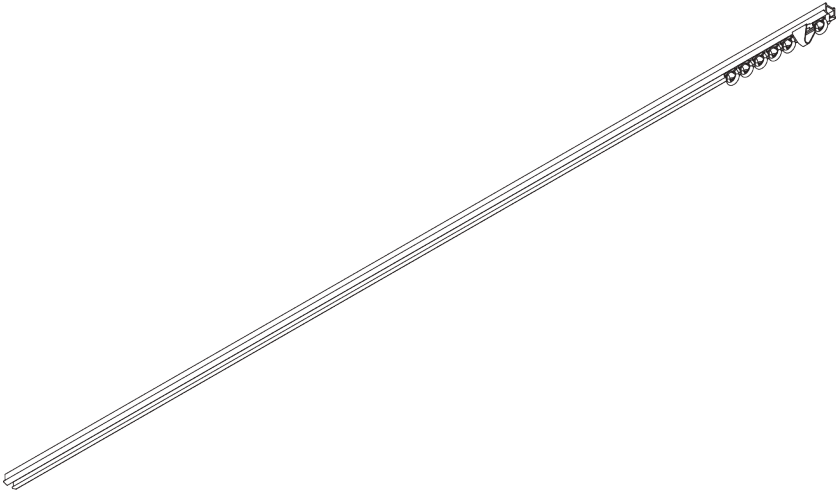
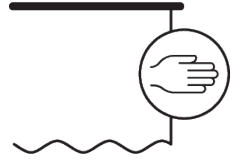

## PRODUCT INFORMATION

- **Operation:** hand
- **Range:** S
- **Fitting:** recess (center SG 7550)
- **Colours:** white RAL 9016 or anodised aluminum, special colours possible
- **Fabrics:** refer to Silent Gliss fabric collection

### **Features:**

- Pre-drilled profile
- Bendable

# SYSTEM SPECIFICATIONS

## A. PROFILE

Profile and bending information

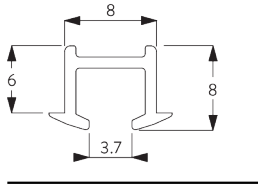

**SG 1011p**

Profile

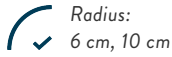

## B. HOW TO MEASURE

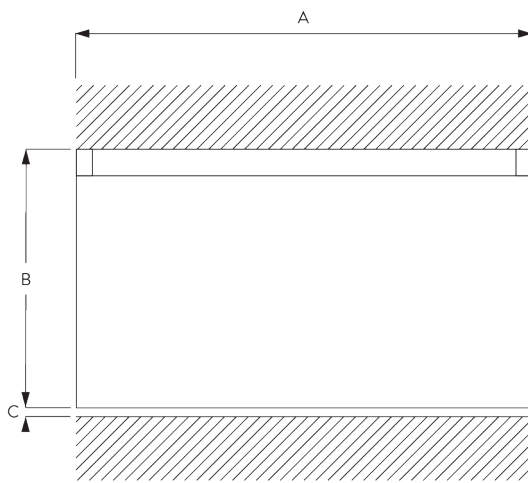

A: System width

B: System height

C: Distance between floor and fabric

## C. SPECIFICATION

### TEXT

#### EN

Silent Gliss SG 1011 Hand Drawn Curtain Track System for recessed fitting. Comprises aluminium profile SG1011 supplied made to measure in silver anodised or white powder coated, alternatively a specified RAL colour. SG 3533 at 14/m and 2 end stops SG 3070/SG 3085 Spring stops per length. Top fixed directly to ceiling with screws at 120 mm centres SG3019/3025.

#### SV

Silent Gliss SG 1011 handdragssystem för infällning. Består av aluminiumprofil SG 1011 i specificerad längd i vitlack, alu natur eller angiven RAL färg. 14 st SG 3533 glid per meter, 2 st SG 3070 vridstopp/SG 3085 fjäder per system. Skruvas direkt i tak m skruv SG 3019/SG 3025 c/c 120 mm.

#### NO

Silent Gliss SG 1011 gardinskinner for innfelling. Består av aluminiumprofil SG 1011 i spesifisert lengde, standard i hvitlakkert eller alu natur. Kan også leveres i ønsket RAL farg. 14 stk SG 3533 glidere pr meter, 2 st SG 3070 vristopp/SG 3085 fjær pr system. Skrus direkte i taket med skrue SG 3019/SG 3025 c/c 120 mm.

#### DA

Silent Gliss SG 1011 håndtrukket gardinskinnesystem til indfældning. Består af en aluminiumprofil SG1011 i ønsket længde, sølvanodiseret eller hvid pulverlakering, alternativt en specificeret RAL-farve. 14 stk. SG 3533 pr. m og 2 stk. SG 3070 endestop eller SG 3085 fjeder pr. længde. Fastgøres direkte i loftet med skruer SG3019/3025 med højst 120 mm afstand.

# FITTING

## A. FITTING INFORMATION

For detailed fitting information, visit the [Silent Gliss website](#).

### Fixing points

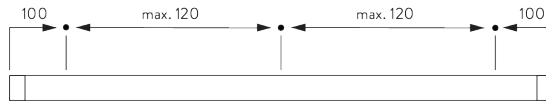

### Profile Protector

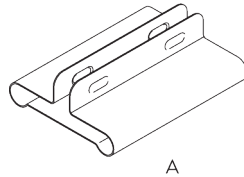

A: Profile Protector SG 7002  
B: Special screw SG 3019 / 12 mm  
C: Special screw SG 3025 / 18 mm

## B. RECESS FITTING



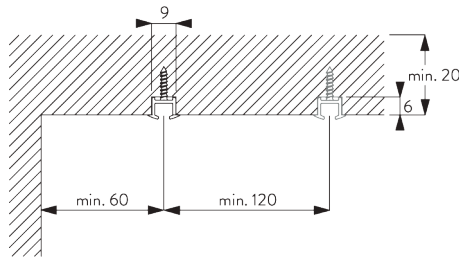

### Direct into wood





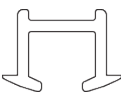
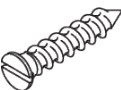









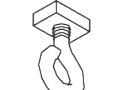
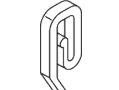

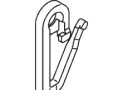
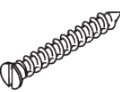
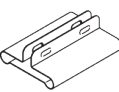

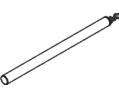
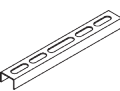
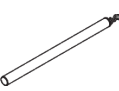

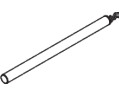
Recess channel: 6 x 9 mm

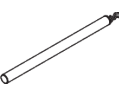
# PARTS

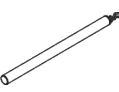
## A. STANDARD PARTS

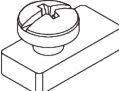
	<b>SG 1011p</b> Profile
	<b>SG 3019</b> Special screw 12 mm
	<b>SG 3070</b> End stop
	<b>SG 3085</b> Spring stop
	<b>SG 3533</b> Glider
	<b>SG 3599</b> Hook

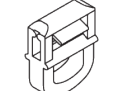
## B. OPTIONAL PARTS

	<b>SG 3012</b> Hook		<b>SG 3571</b> Hook
	<b>SG 3016</b> End stop		<b>SG 3582</b> Hook
	<b>SG 3020</b> Hook		<b>SG 3598</b> Eyelet
	<b>SG 3025</b> Special screw 18 mm		<b>SG 7002</b> Profile protector
	<b>SG 3032</b> Spring stop		<b>SG 10430</b> Draw rod 50 cm
	<b>SG 3063</b> Connection bridge		<b>SG 10431</b> Draw rod 75 cm
	<b>SG 3071</b> End stop		<b>SG 10432</b> Draw rod 100 cm
	<b>SG 3511</b> Glider		<b>SG 10433</b> Draw rod 125 cm
	<b>SG 3534</b> Glider 3533 on strip		<b>SG 10434</b> Draw rod 150 cm
	<b>SG 3535</b> Glider		<b>SG 11335</b> End stop
	<b>SG 3537</b> Glider		
	<b>SG 3548</b> Glider		
	<b>SG 3549</b> Click glider with hook		
	<b>SG 3570</b> Glider		



# SG 1012

---

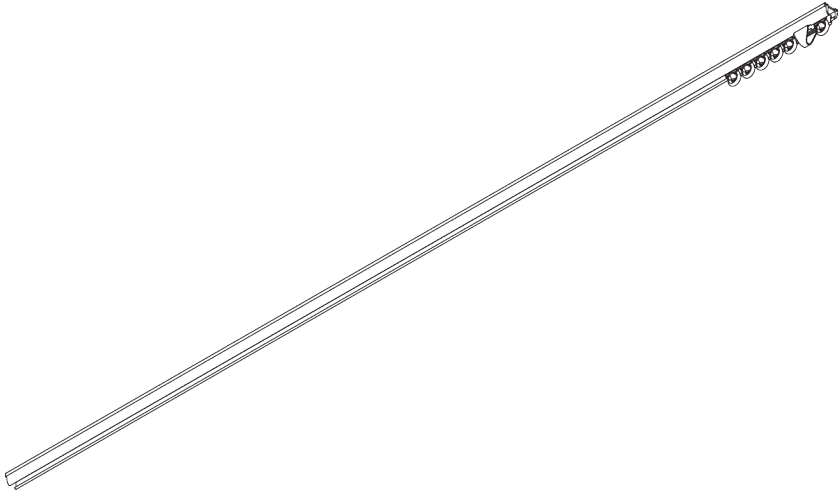

## PRODUCT INFORMATION

- **Operation:** hand
- **Range:** S
- **Fitting:** recess (center SG 7550)
- **Colours:** white RAL 9016 or anodised aluminum, special colours possible
- **Fabrics:** refer to Silent Gliss fabric collection

### **Features:**

- Pre-drilled profile
- Bendable

# SYSTEM SPECIFICATIONS

## A. PROFILE

Profile and bending information

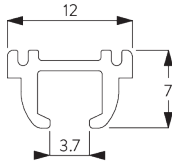

SG 1012p

Profile

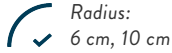

## B. HOW TO MEASURE

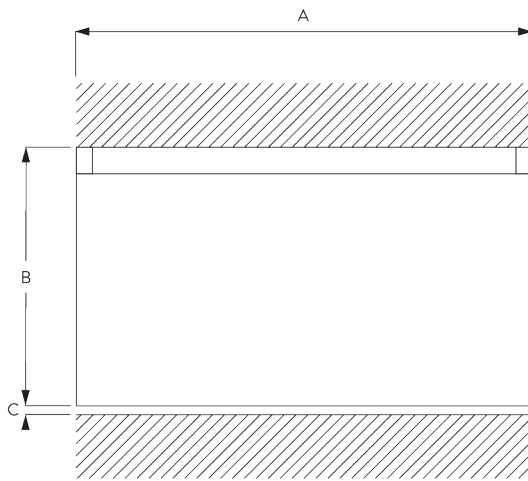

A: System width

B: System height

C: Distance between floor and fabric

## C. SPECIFICATION

TEXT

### EN

Silent Gliss SG 1012 Hand Drawn Curtain Track System. Comprises aluminium profile SG 1012 supplied made to measure in silver anodised or white powder coated, alternatively a specified RAL colour. SG 3533 at 14/m and 2 end covers SG 3512/ end stops SG 3070/SG 3085 Spring stops per length. Top fixed with brackets SG 3112/3121 at max. 120 mm centres. Or directly to ceiling with screws SG 3019/3025.

### SV

Silent Gliss SG 1012 handdragssystem. Består av aluminiumprofil SG 1012 i specificerad längd i vitlack, alu natur eller angiven RAL färg. 14 st SG 3533 glid per meter, 2 st SG 3512 ändskydd samt 2 st SG 3070 vridstopp/SG 3085 fjäder per system. Takmonteras med fäste SG 3112/3121 c/c 120 mm. Alternativt skruvas direkt i tak m skruv SG 3019/SG 3025.

### NO

Silent Gliss SG 1012 manuell gardinskinne. Består av aluminiumprofil SG 1012 i spesifisert lengde, standard i hvitlakkert eller alu natur. Kan også leveres i spesifisert RAL farge. 14 stk SG 3533 glidere pr meter, 2 stk SG 3070 vridstopp/SG 3085 fjær pr system. Takmonteres med feste SG3112/3121 c/c 120 mm. Alternativt skrues skinnen direkte i taket med skruer SG 3019/SG 3025.

### DA

Silent Gliss SG 1012 håndtrukket gardinskinnesystem. Består af en aluminiumprofil SG 1012 i ønsket længde, sølvanodiseret eller hvid pulverlakering, alternativt en specificeret RAL-farve. 14 stk. SG 3533 pr. m og 2 stk. SG 3512 endelåg eller SG 3070/SG 3085 fjeder pr. længde. Loftmonteres med beslagene SG 3112/3121 med højst 120 mm afstand. Eller direkte i loftet med skruer SG3019/3025.

# FITTING

## A. FITTING INFORMATION

For detailed fitting information, visit the Silent Gliss website.

### Fixing points

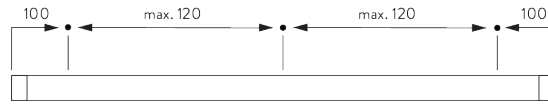

### Profile Protector

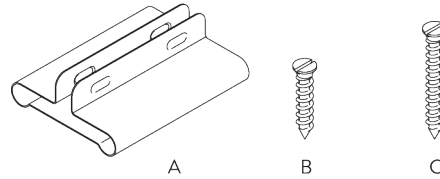

A: Profile Protector SG 7002  
B: Special Screw SG 3019 / 12 mm  
C: Special Screw SG 3025 / 18 mm

## B. CEILING FITTING

### Direct into wood

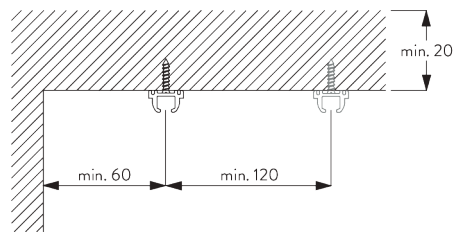

### Bracket SG 3112

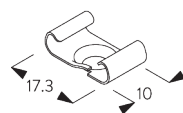
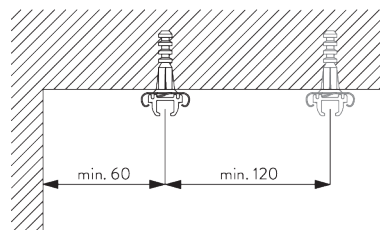

SG 3112  
Bracket

## Bracket SG 3121

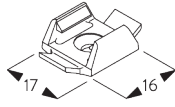
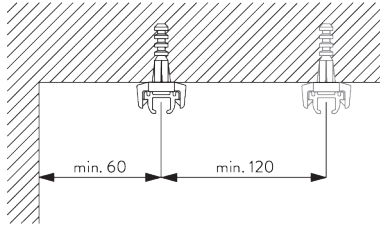





---



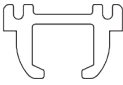
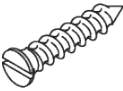











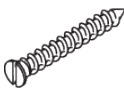

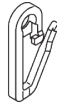
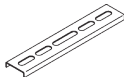

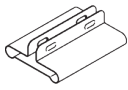
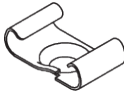
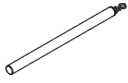
**SG 3121**  
*Bracket*

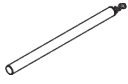
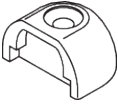
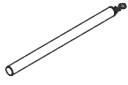
# PARTS

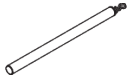
## A. STANDARD PARTS

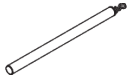
	<b>SG 1012p</b> Profile
	<b>SG 3019</b> Special screw 12 mm
	<b>SG 3070</b> End stop
	<b>SG 3085</b> Spring stop
	<b>SG 3533</b> Glider

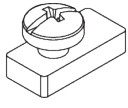
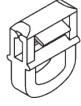
## B. OPTIONAL PARTS

	<b>SG 3016</b> End stop		<b>SG 3570</b> Glider
	<b>SG 3020</b> Hook		<b>SG 3571</b> Hook
	<b>SG 3025</b> Special screw 18 mm		<b>SG 3582</b> Hook
	<b>SG 3032</b> Spring stop		<b>SG 3598</b> Eyelet
	<b>SG 3064</b> Connecting bridge		<b>SG 3599</b> Hook
	<b>SG 3071</b> End stop		<b>SG 7002</b> Profile protector
	<b>SG 3112</b> Bracket		<b>SG 10430</b> Draw rod 50 cm
	<b>SG 3511</b> Glider		<b>SG 10431</b> Draw rod 75 cm
	<b>SG 3512</b> End cover		<b>SG 10432</b> Draw rod 100 cm
	<b>SG 3534</b> Glider 3533 on strip		<b>SG 10433</b> Draw rod 125 cm
	<b>SG 3535</b> Glider		<b>SG 10434</b> Draw rod 150 cm
	<b>SG 3537</b> Glider		<b>SG 11335</b> End stop
	<b>SG 3548</b> Glider		
	<b>SG 3549</b> Click glider with hook		



# SG 1015

---

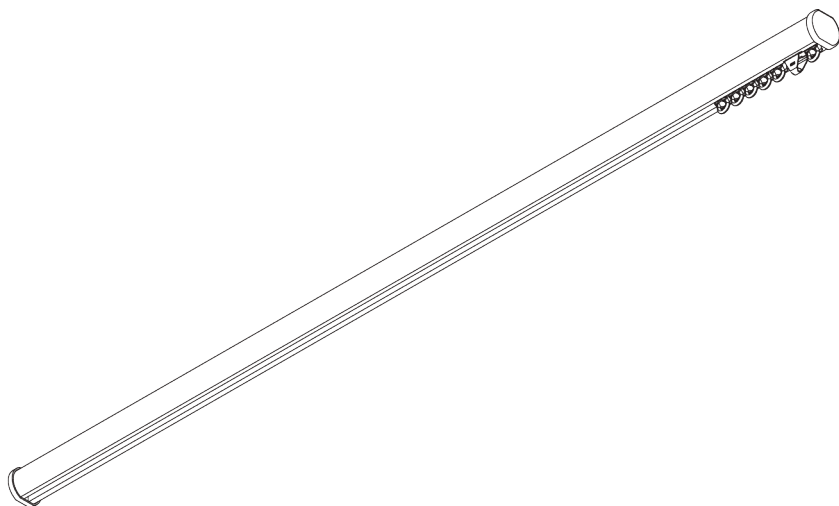
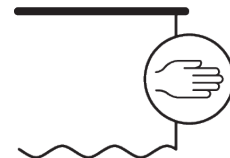

## PRODUCT INFORMATION

- **Operation:** hand
- **Range:** S
- **Fitting:** ceiling, wall
- **Colours:** white RAL 9016 or anodised aluminum, special colours possible
- **Fabrics:** refer to Silent Gliss fabric collection

### **Features:**

- Bendable

# SYSTEM SPECIFICATIONS

## A. PROFILE

Profile and bending information

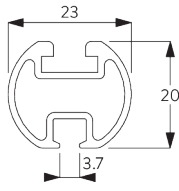

**SG 1003p**

Profile

Radius:  
✓ 15 cm, 20 cm, >25 cm

## B. HOW TO MEASURE

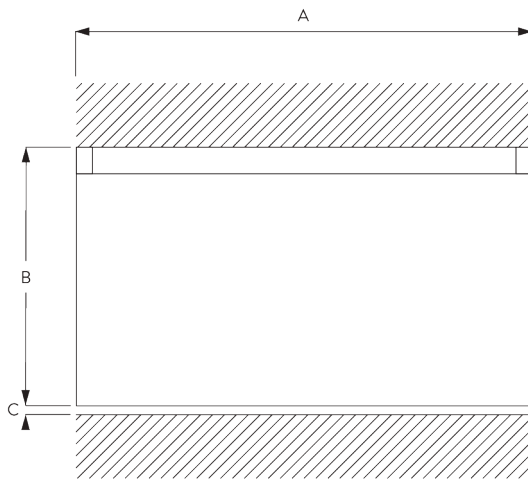

A: System width

B: System height

C: Distance between floor and fabric

## C. SPECIFICATION TEXT

### EN

Silent Gliss SG 1015 Hand Drawn Curtain Track System. Comprises aluminium profile SG 1003 supplied made to measure in silver anodised or white powder coated, alternatively a specified RAL colour. SG 3533 at 14/m and 2 end covers SG 3014/ end stops SG 3070 per length. Top fixed with brackets SG 6175 at max. 800 mm centres / wall fix SG Smart Fix at max. 800 mm centres.

### SV

Silent Gliss SG 1015 handdragssystem. Består av aluminiumprofil SG 1003 i specificerad längd i vitlack, alu natur eller angiven RAL färg. 14 st SG 3533 glid per meter, 2 st SG 3014 ändskydd samt 2 st SG 3070 vridstopp per system. Takmonteras med fäste SG 6124 /SG 6175 c/c 800 mm. Vägghmontering med Smart Fix c/c 800 mm.

### NO

Silent Gliss SG 1015 manuell gardinskinne. Består av aluminiumprofil SG 1003 i spesifisert lengde, standard hvitlakkert eller alu natur. Kan også leveres i spesifisert RAL farge. 14 stk SG 3533 glidere pr meter, 2 stk SG 3070 vrilstopp pr system. Takmonteres med feste SG 6175 c/c 800 mm. Veggmontering med Smart Fix c/c 800mm.

### DA

Silent Gliss SG 1015 håndtrukket gardinskinnesystem. Består af en aluminiumprofil SG 1003 i ønsket længde, sølvanodiseret eller hvid pulverlakering, alternativt en specificeret RAL-farve. 14 stk. SG 3533 glidere pr. m og 2 stk. endelåg SG 3014 samt 2 stk. SG 3070 endestop pr. længde. Loftmonteres med beslagene SG 6175 med højst 800 mm afstand. Vægmonteres med SG Smart Fix med højst 800 mm afstand.



# FITTING

## A. FITTING INFORMATION

### Fixing points

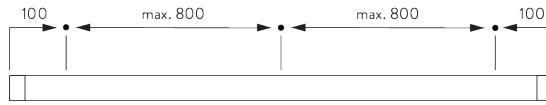

For detailed fitting information, visit the Silent Gliss website.

## B. CEILING FITTING

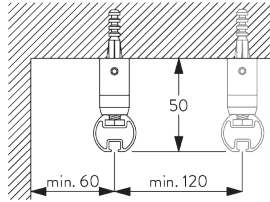

Mini hanger SG 6175

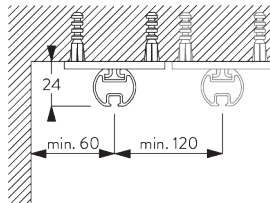

Bracket SG 6124

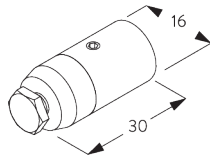

SG 6175  
Mini hanger

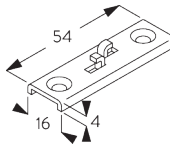

SG 6124  
Bracket

## C. WALL FITTING

### Smart Fix

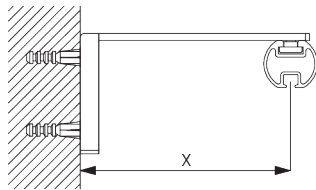

**Smart Fix with slot SG 11206 - SG 11208:**  
Screw SG 10492 (M4x8) needed.

Smart Fix	X mm
SG 11206 / SG 11216	33-51
SG 11207 / SG 11217	53-71
SG 11208 / SG 11218	73-91
SG 11154	102-130
SG 11155	132-160
SG 11156	182-210

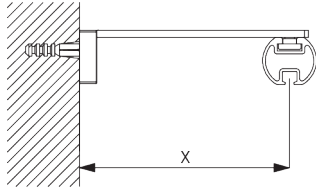

**Square Smart Fix with slot SG 11216 - SG 11218:**

Screw SG 10492 (M4x8) needed.

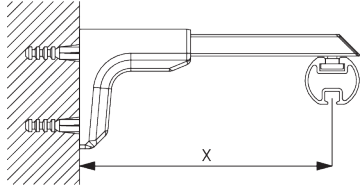

**Universal Smart Fix SG 11154 - SG 11156:**

Screw SG 11131 (M4x6) needed.

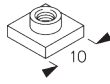

**SG 6117**

Slot nut



**SG 10492**

Pan head screw M4x8



**SG 11131**

Pan head screw with flange M4x6

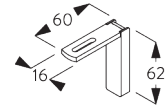

**SG 11206**

Smart Fix with slot 60 mm

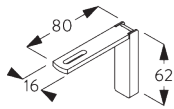

**SG 11207**

Smart Fix with slot 80 mm

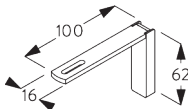

**SG 11208**

Smart Fix with slot 100 mm

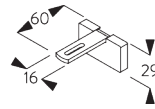

**SG 11216**

Square Smart Fix with slot 60 mm

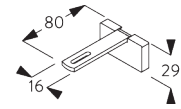

**SG 11217**

Square Smart Fix with slot 80 mm

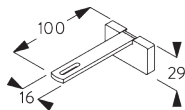

**SG 11218**

Square Smart Fix with slot 100 mm

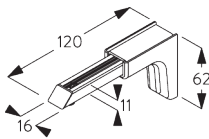

**SG 11154**

Universal Smart Fix 120 mm

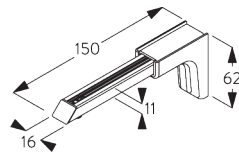

**SG 11155**

Universal Smart Fix 150 mm

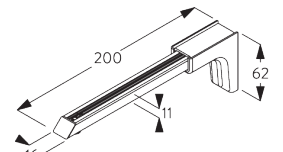







**SG 11156**

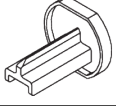

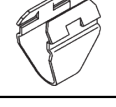

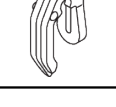

Universal Smart Fix 200 mm

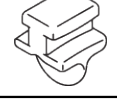

# PARTS

## A. STANDARD PARTS

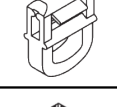
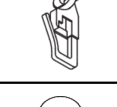
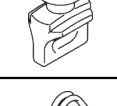
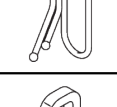
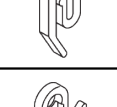
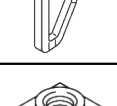
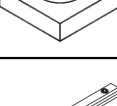
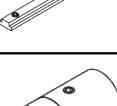
	<b>SG 1003p</b> Profile
	<b>SG 3014</b> End cover
	<b>SG 3070</b> End stop
	<b>SG 3085</b> Spring stop
	<b>SG 3533</b> Glider
	<b>SG 3599</b> Hook
	<b>SG 6124</b> Bracket

## B. OPTIONAL PARTS

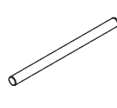
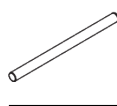
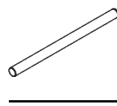
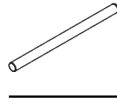
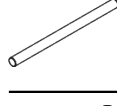
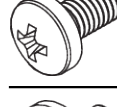
	<b>SG 3012</b> Hook
	<b>SG 3511</b> Glider
	<b>SG 3534</b> Glider 3533 on strip
	<b>SG 3535</b> Glider
	<b>SG 3537</b> Glider
	<b>SG 3548</b> Glider
	<b>SG 3549</b> Click glider with hook
	<b>SG 3570</b> Glider
	<b>SG 3581</b> Hook
	<b>SG 3582</b> Hook
	<b>SG 3598</b> Eyelet
	<b>SG 6117</b> Slot nut
	<b>SG 6173</b> Connection bridge
	<b>SG 6175</b> Mini hanger

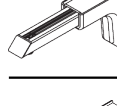
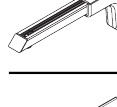
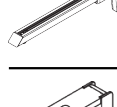
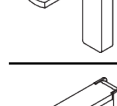
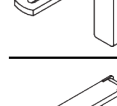
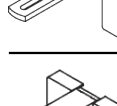
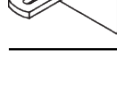
	<b>SG 10430</b> Draw rod 50 cm
	<b>SG 10431</b> Draw rod 75 cm
	<b>SG 10432</b> Draw rod 100 cm
	<b>SG 10433</b> Draw rod 125 cm
	<b>SG 10434</b> Draw rod 150 cm
	<b>SG 10492</b> Pan head screw M4x8
	<b>SG 11131</b> Pan head screw with flange M4x6
	<b>SG 11154</b> Universal Smart Fix 120 mm
	<b>SG 11155</b> Universal Smart Fix 150 mm
	<b>SG 11156</b> Universal Smart Fix 200 mm
	<b>SG 11206</b> Smart Fix with slot 60 mm
	<b>SG 11207</b> Smart Fix with slot 80 mm
	<b>SG 11208</b> Smart Fix with slot 100 mm
	<b>SG 11216</b> Square Smart Fix with slot 60 mm

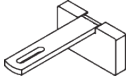

---

**SG 11217**

Square Smart Fix with slot 80 mm

---

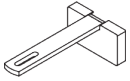

---

**SG 11218**

Square Smart Fix with slot 100 mm

---

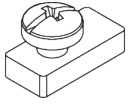

---

**SG 11335**

End stop

---

# SG 1020

---

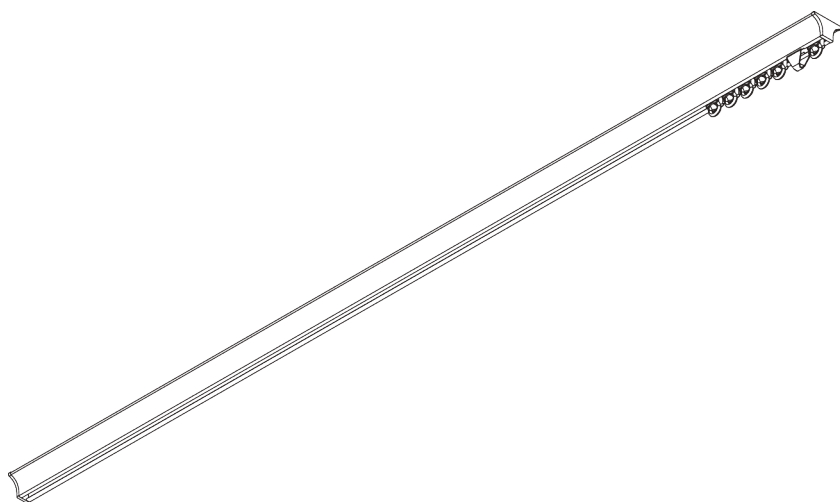
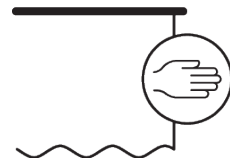

## PRODUCT INFORMATION

- **Operation:** hand
- **Range:** S
- **Fitting:** ceiling
- **Colours:** white RAL 9016 or anodised aluminum, special colours possible
- **Fabrics:** refer to Silent Gliss fabric collection

### **Features:**

- Symmetrical Funnel design
- Bendable

# SYSTEM SPECIFICATIONS

## A. SYSTEM DIMENSIONS



10 kg

## B. PROFILE

Profile and bending information

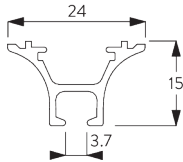

**SG 6822**

Profile Funnel

Radius: >27 cm

## C. HOW TO MEASURE

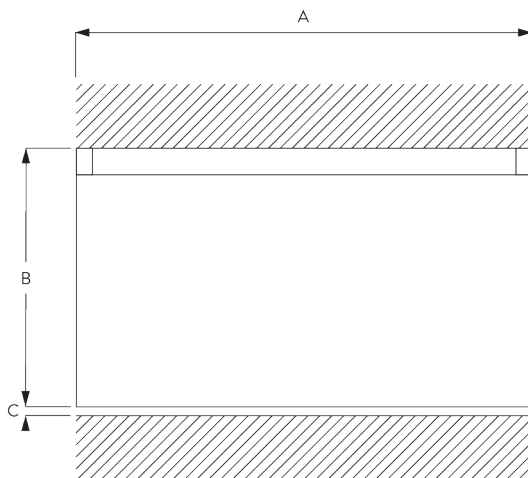

A: System width

B: System height

C: Distance between floor and fabric

## **D. SPECIFICATION**

### **TEXT**

#### **EN**

Silent Gliss SG 1020 Hand Drawn Curtain Track System. Comprises aluminium profile SG 6822 supplied made to measure in silver anodised or white powder coated, alternatively a specified RAL colour. SG 3533 at 14/m and 2 end covers SG 6824 / end stops SG 3070 per length. Top fixed with bracket SG 11236 at max. 500 mm centres.

#### **SV**

Silent Gliss SG 1020 handdragssystem. Består av aluminiumprofil SG 6822 i specificerad längd i vitlack, alu natur eller angiven RAL färg. 14 st SG 3533 glid per meter, 2 st SG 6824 ändskydd samt 2 st SG 3070 vridstopp per system. Takmonteras med fäste SG 11236 c/c 500 mm.

#### **NO**

Silent Gliss SG 1020 manuell gardinskinne. Består av aluminiumprofil SG 6822 i spesifisert lengde, standard i hvitlakkert eller alu natur. Kan også leveres i spesifisert RAL farge. 14 stk SG 3533 glidere pr meter, 2 stk SG 6824 endestykker samt 2 stk SG 3070 vristopp pr system. Takmonteres med feste SG 11236 c/c 500 mm.

#### **DA**

Silent Gliss SG 1020 håndtrukket gardinskinnesystem. Består af en aluminiumprofil SG 6822 i ønsket længde, sølvanodiseret eller hvid pulverlakering, alternativt en specificeret RAL-farve. 14 stk. SG 3533 glidere pr. m og 2 stk. SG 6824 endelåg samt 2 stk. SG 3070 endestop pr. længde. Loftmonteres med beslag SG 11236 med højst 500 mm afstand.

# **FITTING**

## **A. FITTING INFORMATION**

For detailed fitting information, visit the Silent Gliss website.

### **Fixing points**

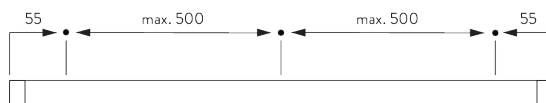

### **Fitting Tool**

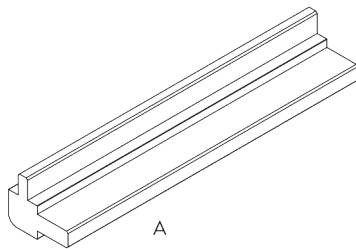

A: Funnel fitting tool SG 6827

For fitting / removing of the funnel profile.

## **B. CEILING FITTING**

### **Clip SG 11236**

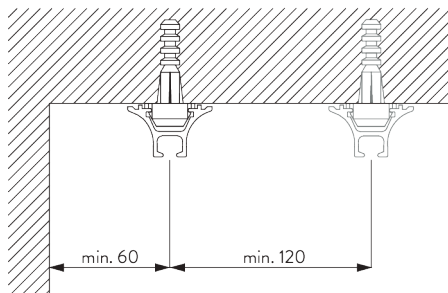

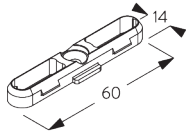







**SG 11236**

*Clip*







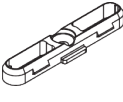

# PARTS

## A. STANDARD PARTS

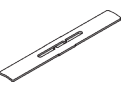
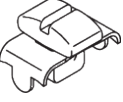
	<b>SG 3070</b> End stop
	<b>SG 3085</b> Spring stop
	<b>SG 3533</b> Glider
	<b>SG 3599</b> Hook
	<b>SG 6822</b> Profile Funnel
	<b>SG 6824</b> End cover
	<b>SG 11236</b> Clip

## B. OPTIONAL PARTS

	<b>SG 3012</b> Hook
	<b>SG 3016</b> End stop
	<b>SG 3062</b> Connection bridge
	<b>SG 3071</b> End stop
	<b>SG 3511</b> Glider
	<b>SG 3534</b> Glider 3533 on strip
	<b>SG 3535</b> Glider
	<b>SG 3537</b> Glider
	<b>SG 3548</b> Glider
	<b>SG 3549</b> Click glider with hook
	<b>SG 3555</b> Hook
	<b>SG 3570</b> Glider
	<b>SG 3582</b> Hook
	<b>SG 3598</b> Eyelet

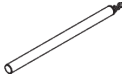
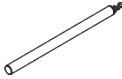
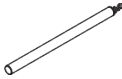
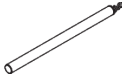
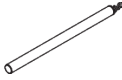
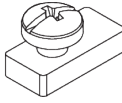
	<b>SG 10430</b> Draw rod 50 cm
	<b>SG 10431</b> Draw rod 75 cm
	<b>SG 10432</b> Draw rod 100 cm
	<b>SG 10433</b> Draw rod 125 cm
	<b>SG 10434</b> Draw rod 150 cm
	<b>SG 11335</b> End stop



# SG 1060

---

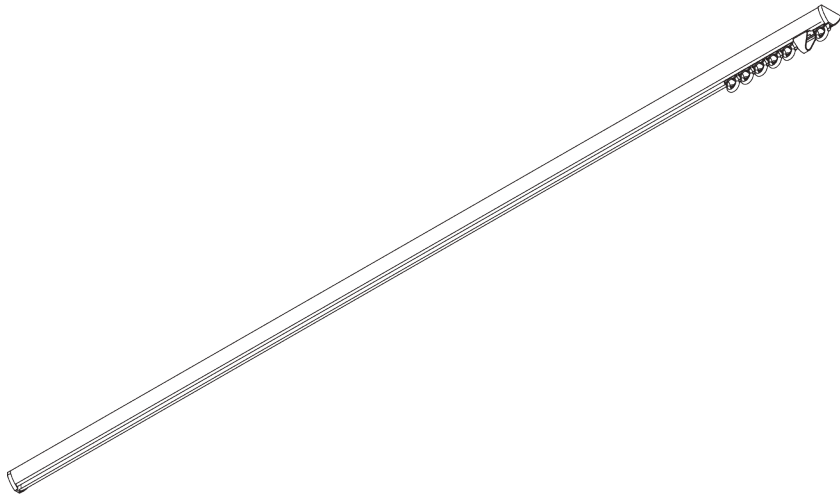
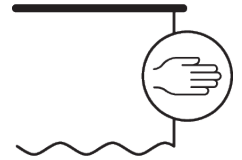

## PRODUCT INFORMATION

- **Operation:** hand
- **Range:** S
- **Fitting:** ceiling
- **Colours:** white RAL 9016 or anodised aluminum, special colours possible
- **Fabrics:** refer to Silent Gliss fabric collection

### **Features:**

- Bendable

# SYSTEM SPECIFICATIONS

## A. PROFILE

Profile and bending information

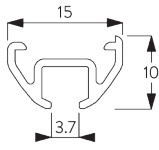

**SG 1060p**

Profile

Radius:  
✓ 6 cm, 10 cm, 12 cm,  
20 cm, >30 cm

## B. HOW TO MEASURE

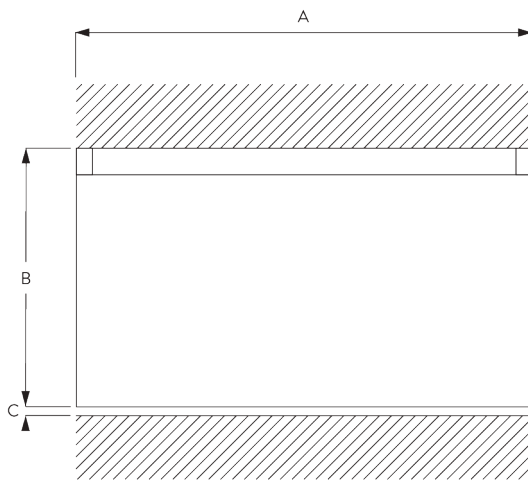

A: System width

B: System height

C: Distance between floor and fabric

## C. SPECIFICATION

### TEXT

#### EN

Silent Gliss SG 1060 Hand Drawn Curtain Track System. Comprises aluminium profile SG1060 supplied made to measure in silver anodised or white powder coated, alternatively a specified RAL colour. SG 3533 at 14/m and 2 end covers SG 3061/ end stops SG 3070 per length. Top fixed with brackets SG 3060 at max. 300 mm centres.

#### SV

Silent Gliss SG 1060 handdragssystem. Består av aluminiumprofil SG 1060 i specificerad längd i vitlack, alu natur eller angiven RAL färg. 14 st SG 3533 glid per meter, 2 st SG 3061 ändskydd samt 2 st SG 3070 vridstopp per system. Takmonteras med fäste SG 3060 c/c 300 mm.

#### NO

Silent Gliss SG 1060 manuell gardinskinne. Består av aluminiumprofil SG 1060 i spesifisert lengde, standard i hvitlakkert eller alu natur. Kan også leveres i spesifisert RAL farge. 14 stk SG 3533 glidere pr meter, 2 stk SG 3061 endeløkk samt 2 stk SG 3070 vridstopp pr system. Takmonteres med feste SG 3060 c/c 300 mm.

#### DA

Silent Gliss SG 1060 håndtrukket gardinskinnesystem. Består af en aluminiumprofil SG1060 i ønsket længde, sølvanodiseret eller hvid pulverlakering, alternativt en specificeret RAL-farve. 14 stk. SG 3533 glidere pr. m og 2 stk. endelåg SG 3061 samt 2 stk. SG 3070 endestop pr. længde. Loftmonteres med beslagene SG 3060 med højst 300 mm afstand.

# FITTING

## A. FITTING INFORMATION

For detailed fitting information, visit the *Silent Gliss* website.

### Fixing points

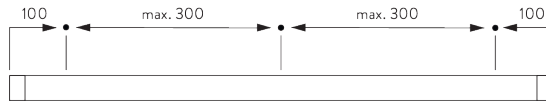

## B. CEILING FITTING



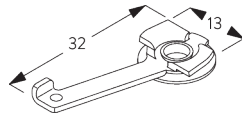
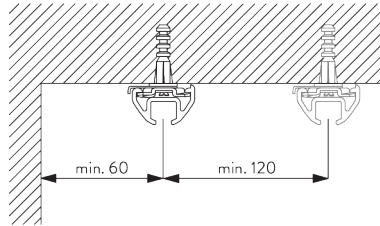

### Clamp SG 3060





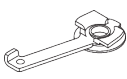
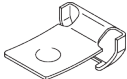





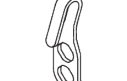
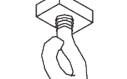
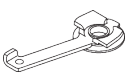

**SG 3060**  
Clamp



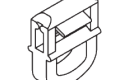

# PARTS

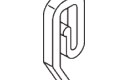
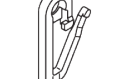
## A. STANDARD PARTS

	<b>SG 1060p</b> Profile
	<b>SG 3060</b> Clamp
	<b>SG 3061</b> End cover
	<b>SG 3070</b> End stop
	<b>SG 3085</b> Spring stop
	<b>SG 3533</b> Glider
	<b>SG 3599</b> Hook

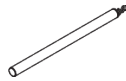
## B. OPTIONAL PARTS

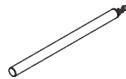
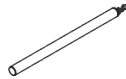
	<b>SG 3012</b> Hook
	<b>SG 3016</b> End stop
	<b>SG 3060</b> Clamp
	<b>SG 3062</b> Connection bridge
	<b>SG 3511</b> Glider
	<b>SG 3534</b> Glider 3533 on strip
	<b>SG 3535</b> Glider
	<b>SG 3537</b> Glider
	<b>SG 3548</b> Glider
	<b>SG 3549</b> Click glider with hook
	<b>SG 3570</b> Glider
	<b>SG 3582</b> Hook
	<b>SG 3598</b> Eyelet
	<b>SG 10430</b> Draw rod 50 cm

	<b>SG 10431</b> Draw rod 75 cm
	<b>SG 10432</b> Draw rod 100 cm
	<b>SG 10433</b> Draw rod 125 cm
	<b>SG 10434</b> Draw rod 150 cm
	<b>SG 11335</b> End stop

# SG 1070

---

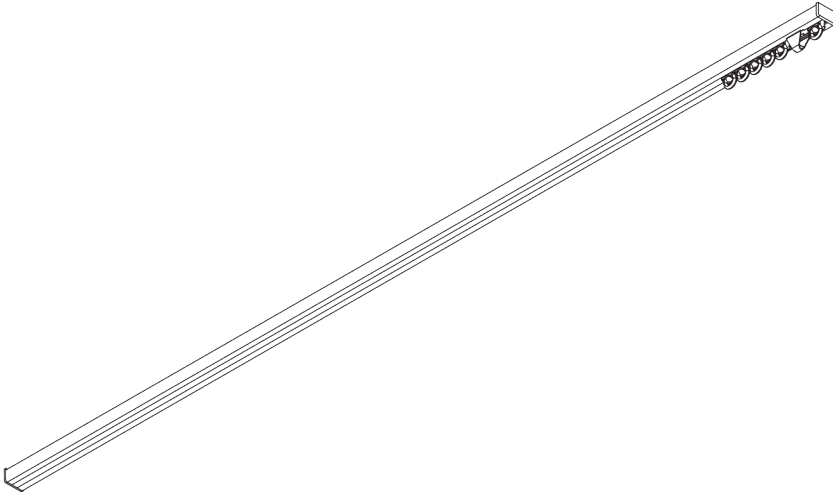

## PRODUCT INFORMATION

- **Operation:** hand
- **Range:** S
- **Fitting:** ceiling
- **Colours:** white RAL 9016 or anodised aluminum, special colours possible
- **Fabrics:** refer to Silent Gliss fabric collection

### **Features:**

- Bendable

# SYSTEM SPECIFICATIONS

## A. PROFILE

### Profile and bending information

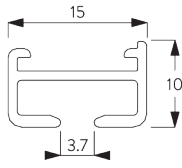

#### SG 1071

Profile 1071

Radius:  
8 cm, 12 cm, 16 cm,  
>25 cm

## B. HOW TO MEASURE

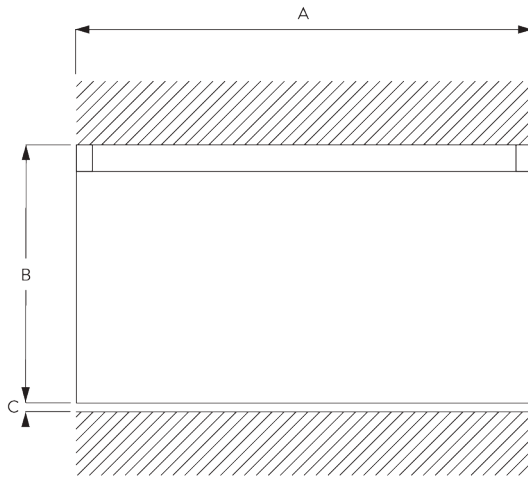

A: System width  
B: System height  
C: Distance between floor and fabric

## C. SPECIFICATION TEXT

### EN

Silent Gliss SG 1070 Hand Drawn Curtain Track System. Comprises aluminium profile SG1071 supplied made to measure in silver anodised or white powder coated, alternatively a specified RAL colour. SG 3533 at 14/m and 2 end covers SG 1072/ end stops SG 3070 per length. Top fixed with brackets SG 3060 at max. 300 mm centres.

### SV

Silent Gliss SG 1070 handdragssystem. Består av aluminiumprofil SG 1071 i specificerad längd i vitlack, alu natur eller angiven RAL färg. 14 st SG 3533 glid per meter, 2 st SG 1072 ändskydd samt 2 st SG 3070 vridstopp per system. Takmonteras med fäste SG 3060 c/c 300 mm.

### NO

Silent Gliss SG 1070 manuell gardinskinne. Består av aluminiumprofil SG 1071 i spesifisert lengde, standard i hvitlakkert eller alu natur. Kan også leveres i spesifisert RAL farge. 14 stk SG 3533 glidere pr meter, 2 stk SG 1072 endestykker samt 2 stk SG 3070 vristopp pr system. Takmonteres med feste SG 3060 c/c 300 mm.

### DA

Silent Gliss SG 1070 håndtrukket gardinskinnesystem. Består af en aluminiumprofil SG1071 i ønsket længde, sølvanodiseret eller hvid pulverlakering, alternativt en specificeret RAL-farve. 14 stk. SG 3533 glidere pr. m og 2 stk. endelæg SG 1072 samt 2 stk. SG 3070 endestop pr. længde. Loftmonteres med beslagene SG 3060 med højst 300 mm afstand.



# FITTING

## A. FITTING INFORMATION

For detailed fitting information, visit the *Silent Gliss* website.

### Fixing points

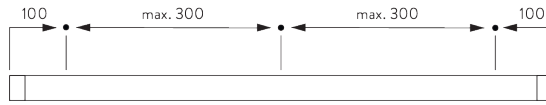

## B. CEILING FITTING



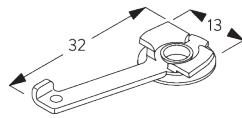
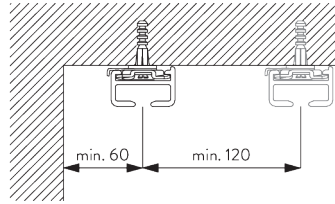

### Clamp SG 3060





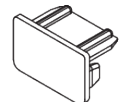
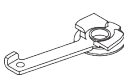

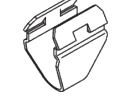
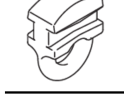

**SG 3060**  
Clamp

# PARTS

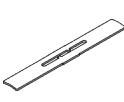
## A. STANDARD PARTS

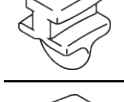
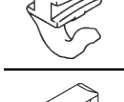
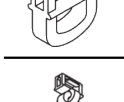
	<b>SG 1071</b> Profile 1071
	<b>SG 1072</b> End cover
	<b>SG 3060</b> Clamp
	<b>SG 3070</b> End stop
	<b>SG 3085</b> Spring stop
	<b>SG 3533</b> Glider
	<b>SG 3599</b> Hook

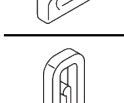
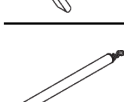
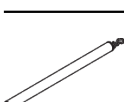
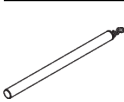
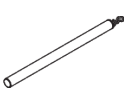
## B. OPTIONAL PARTS

	<b>SG 3012</b> Hook
	<b>SG 3062</b> Connection bridge
	<b>SG 3511</b> Glider
	<b>SG 3534</b> Glider 3533 on strip
	<b>SG 3535</b> Glider
	<b>SG 3537</b> Glider
	<b>SG 3548</b> Glider
	<b>SG 3549</b> Click glider with hook
	<b>SG 3570</b> Glider
	<b>SG 3582</b> Hook
	<b>SG 10430</b> Draw rod 50 cm
	<b>SG 10431</b> Draw rod 75 cm
	<b>SG 10432</b> Draw rod 100 cm
	<b>SG 10433</b> Draw rod 125 cm

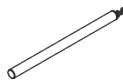
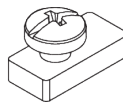
	<b>SG 10434</b> Draw rod 150 cm
	<b>SG 11335</b> End stop

# SG 1080

---

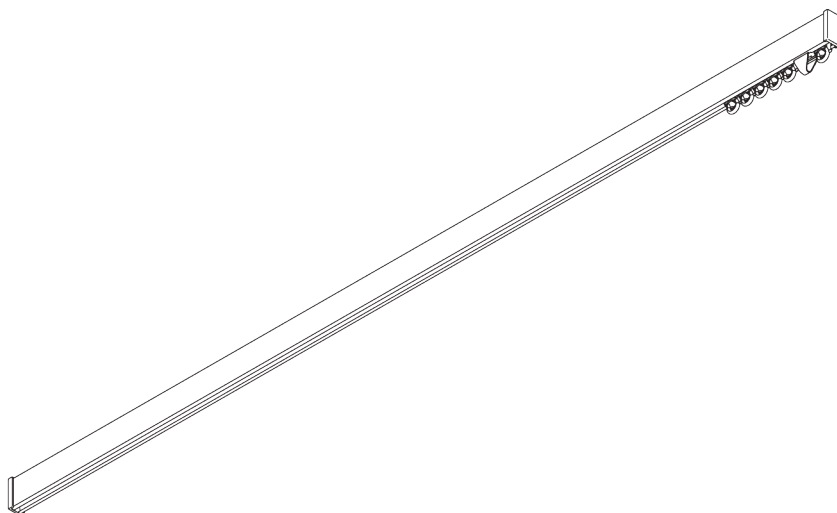
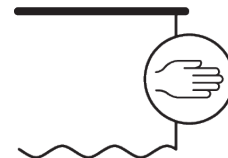

## PRODUCT INFORMATION

- **Operation:** hand
- **Range:** S
- **Fitting:** ceiling, wall, suspended
- **Colours:** white RAL 9016, black RAL 9005 or anodised aluminum, special colours possible
- **Fabrics:** refer to Silent Gliss fabric collection

### **Features:**

- Bendable

# SYSTEM SPECIFICATIONS

## A. PROFILE

Profile and bending information

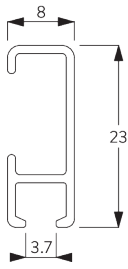

**SG 1080p**

Profile

Radius:  
✓ 6 cm, 10 cm, >30 cm

## B. HOW TO MEASURE

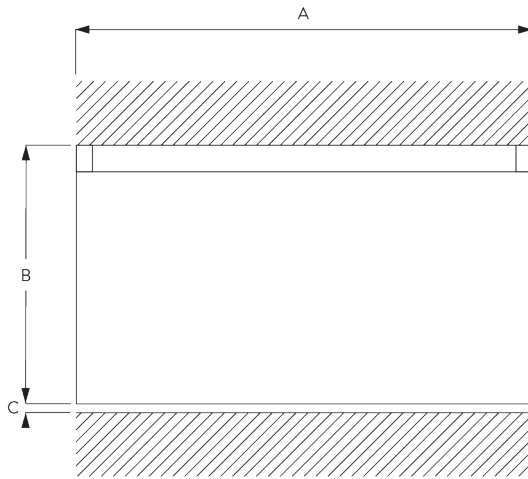

A: System width

B: System height

C: Distance between floor and fabric

## C. SPECIFICATION

### TEXT

#### EN

*Silent Gliss SG 1080 Hand Drawn Curtain Track System. Comprises aluminium profile SG1080 supplied made to measure in silver anodised or white powder coated, alternatively a specified RAL colour. SG 3533 at 14/m and 2 end covers SG 3605/ end stops SG 3070 per length. Top fixed with brackets SG 3603 at max. 600 mm centres / wall fix SG Smart Fix at max. 600 mm centres.*

#### SV

*Silent Gliss SG 1080 handdragssystem. Består av aluminiumprofil SG 1080 i specificerad längd i vitlack, alu natur eller angiven RAL färg. 14 st SG 3533 glid per meter, 2 st SG 3605 ändskydd samt 2 st SG 3070 vridstopp per system. Takmonteras med fäste SG 3603 c/c 600 mm. Vägghäring med Smart Fix c/c 600 mm.*

#### NO

*Silent Gliss SG 1080 manuelle gardinskiner. Systemet består av SG 1080 i ønsket legde, hvit, alu natur eller i valgfri RAL farge. 14 stk glidere SG 3533 pr. meter, 2 stk endeløkk SG 3605 og 2 stk vristopp SG 3070 pr system. Takmontering med feste SG 3603 c/c 600 mm. Veggmontering med Smart Fix c/c 600 mm.*

#### DA

*Silent Gliss SG 1080 håndtrukket gardinskinnesystem. Består af en aluminiumprofil SG 1080 i ønsket længde, sølvanodiseret eller hvid pulverlakering, alternativt en specificeret RAL-farve. 14 stk. SG 3533 glidere pr. m og 2 stk. endelåg SG 3605 samt 2 stk. SG 3070 endestop pr. længde. Loftmonteres med beslagene SG 3603 med højst 600 mm afstand. Vægmonteres med SG Smart Fix med højst 600 mm afstand*

# FITTING

## A. FITTING INFORMATION

For detailed fitting information, visit the Silent Gliss website.

### Fixing points

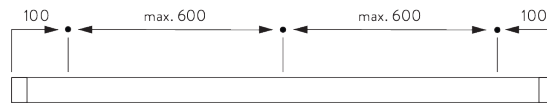

## B. CEILING FITTING

### Bracket SG 3603

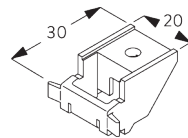
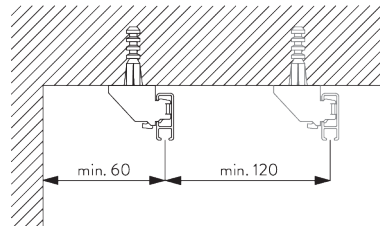

**SG 3603**  
Bracket

## C. WALL FITTING

### Smart Fix

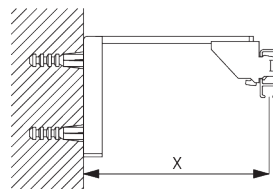

**Smart Fix SG 11200 - SG 11205 and bracket SG 3603:**  
Screw SG 10492 (M4x8) needed.

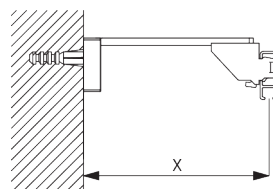

**Square Smart Fix SG 11210 - SG 11215 and bracket SG 3603:**  
Screw SG 10492 (M4x8) needed.

Smart Fix	X mm
SG 11200 / SG 11210	70
SG 11201 / SG 11211	90
SG 11202 / SG 11212	110
SG 11203 / SG 11213	130
SG 11204 / SG 11214	160
SG 11205 / SG 11215	210
SG 11154	120-148
SG 11155	150-178
SG 11156	200-228

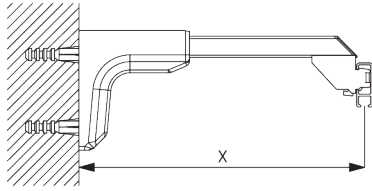

**Universal Smart Fix SG 11154 - SG 11156 and bracket  
SG 3603:**

Screw SG 10277 (M4x12) needed.

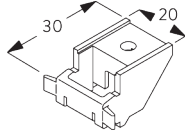

**SG 3603**

Bracket



**SG 10492**

Pan head screw M4x8



**SG 10277**

Pan head screw M4x12

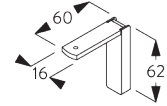

**SG 11200**

Smart Fix 60 mm

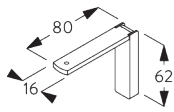

**SG 11201**

Smart Fix 80 mm

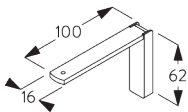

**SG 11202**

Smart Fix 100 mm

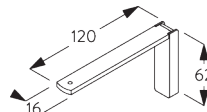

**SG 11203**

Smart Fix 120 mm

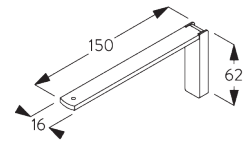

**SG 11204**

Smart Fix 150 mm

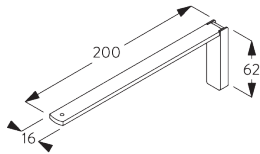

**SG 11205**

Smart Fix 200 mm

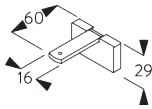

**SG 11210**

Square Smart Fix 60 mm

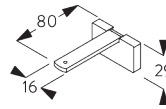

**SG 11211**

Square Smart Fix 80 mm

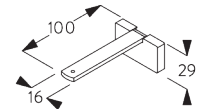

**SG 11212**

Square Smart Fix 100 mm

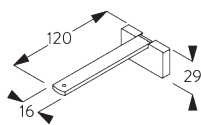

**SG 11213**

Square Smart Fix 120 mm

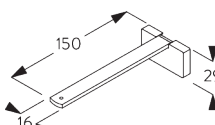

**SG 11214**

Square Smart Fix 150 mm

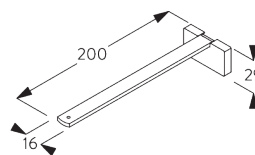

**SG 11215**

Square Smart Fix 200 mm

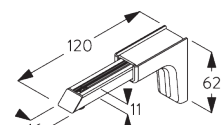

**SG 11154**

Universal Smart Fix 120 mm

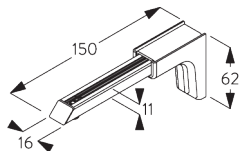

**SG 11155**

Universal Smart Fix 150 mm

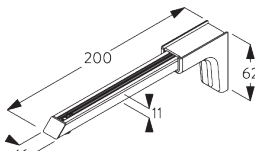

**SG 11156**

Universal Smart Fix 200 mm

**Universal brackets  
SG 3630, SG 3655,  
SG 3660**

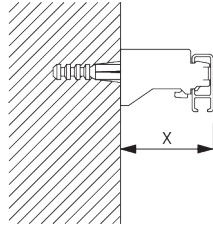

<b>Bracket</b>	<b>X mm</b>
SG 3630	33
SG 3655	48
SG 3660	63

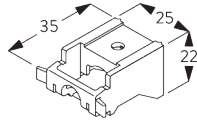

**SG 3630**  
Bracket 35 mm

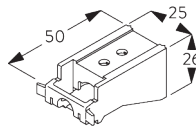

**SG 3655**  
Bracket 50 mm

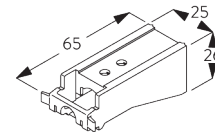

**SG 3660**  
Bracket 65 mm

**D. SUSPENDED  
FITTING**

**Hanger SG 3639 /  
SG 3610 & wall  
support SG 3602**

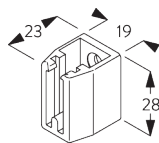
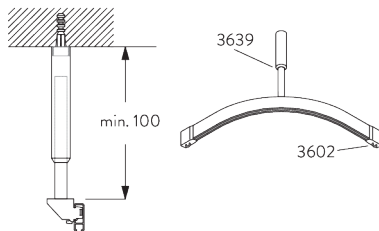

**SG 3602**  
Wall support

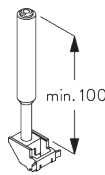

**SG 3639**  
Hanger

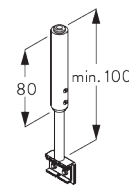















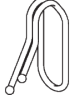

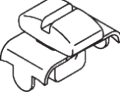
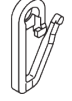

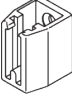

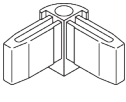

**SG 3610**  
Hanger

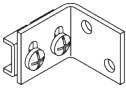
# PARTS

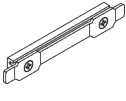
## A. STANDARD PARTS

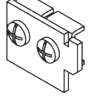
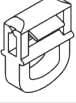
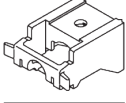
	<b>SG 1080p</b> Profile
	<b>SG 3070</b> End stop
	<b>SG 3085</b> Spring stop
	<b>SG 3533</b> Glider
	<b>SG 3599</b> Hook
	<b>SG 3603</b> Bracket
	<b>SG 3605</b> End cover

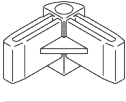
## B. OPTIONAL PARTS

	<b>SG 3012</b> Hook		<b>SG 3570</b> Glider
	<b>SG 3016</b> End stop		<b>SG 3571</b> Hook
	<b>SG 3020</b> Hook		<b>SG 3581</b> Hook
	<b>SG 3032</b> Spring stop		<b>SG 3582</b> Hook
	<b>SG 3071</b> End stop		<b>SG 3598</b> Eyelet
	<b>SG 3089</b> Glider with hook		<b>SG 3602</b> Wall support
	<b>SG 3151</b> Spacer		<b>SG 3604</b> Corner connector
	<b>SG 3511</b> Glider		<b>SG 3610</b> Hanger
	<b>SG 3534</b> Glider 3533 on strip		<b>SG 3618</b> Wall bracket
	<b>SG 3535</b> Glider		<b>SG 3620</b> Connection bridge
	<b>SG 3537</b> Glider		<b>SG 3626</b> Return holder
	<b>SG 3548</b> Glider		<b>SG 3630</b> Bracket 35 mm
	<b>SG 3549</b> Click glider with hook		<b>SG 3638</b> Corner connector
	<b>SG 3555</b> Hook		<b>SG 3639</b> Hanger





**SG 3648**

Eyelet

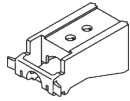

**SG 3655**

Bracket 50 mm

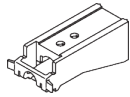

**SG 3660**

Bracket 65 mm

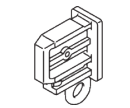

**SG 3667**

End cover



**SG 6146**

Hook

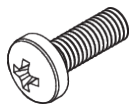

**SG 10277**

Pan head screw M4x12

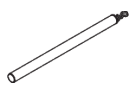

**SG 10430**

Draw rod 50 cm



**SG 10431**

Draw rod 75 cm

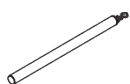

**SG 10432**

Draw rod 100 cm

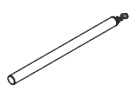

**SG 10433**

Draw rod 125 cm

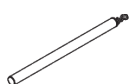

**SG 10434**

Draw rod 150 cm



**SG 10492**

Pan head screw M4x8

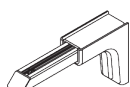

**SG 11154**

Universal Smart Fix 120 mm

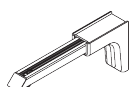

**SG 11155**

Universal Smart Fix 150 mm

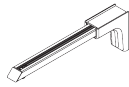

**SG 11156**

Universal Smart Fix 200 mm

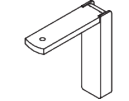

**SG 11200**

Smart Fix 60 mm

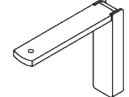

**SG 11201**

Smart Fix 80 mm

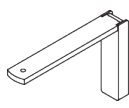

**SG 11202**

Smart Fix 100 mm

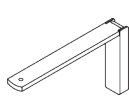

**SG 11203**

Smart Fix 120 mm

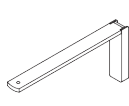

**SG 11204**

Smart Fix 150 mm

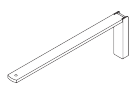

**SG 11205**

Smart Fix 200 mm

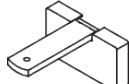

**SG 11210**

Square Smart Fix 60 mm

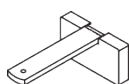

**SG 11211**

Square Smart Fix 80 mm

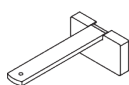

**SG 11212**

Square Smart Fix 100 mm

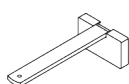

**SG 11213**

Square Smart Fix 120 mm

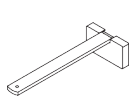

**SG 11214**

Square Smart Fix 150 mm

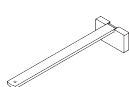

**SG 11215**

Square Smart Fix 200 mm

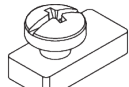

**SG 11335**

End stop



# SG 1090

---

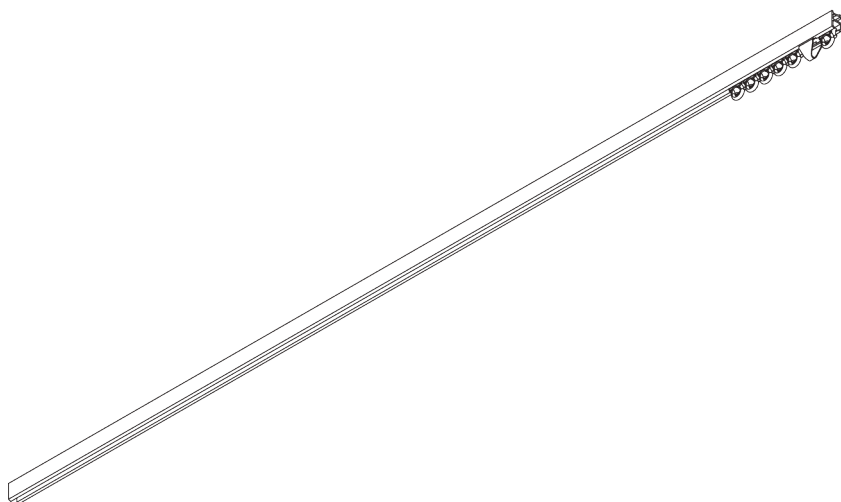
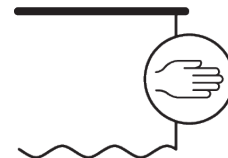

## PRODUCT INFORMATION

- **Operation:** hand
- **Range:** S
- **Fitting:** ceiling, wall
- **Colours:** white RAL 9016 or anodised aluminum, special colours possible
- **Fabrics:** refer to Silent Gliss fabric collection

### **Features:**

- Bendable

# SYSTEM SPECIFICATIONS

## A. PROFILE

Profile and bending information

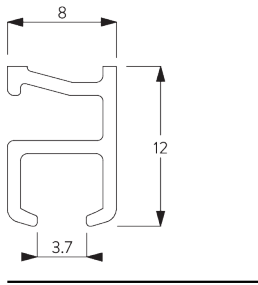

**SG 1090p**

Profile

Radius:  
✓ 6 cm, 10 cm

## B. HOW TO MEASURE

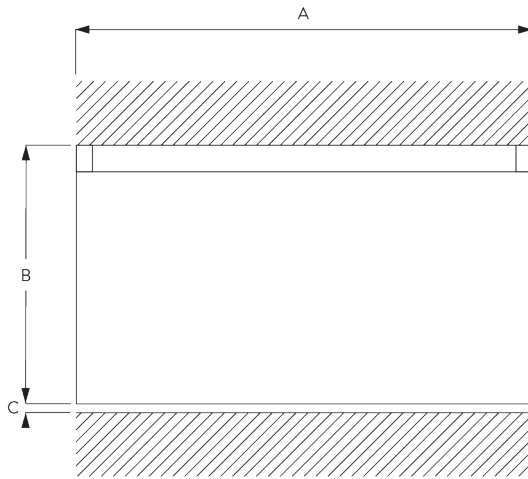

A: System width

B: System height

C: Distance between floor and fabric

## C. SPECIFICATION TEXT

### EN

Silent Gliss SG 1090 Hand Drawn Curtain Track System. Comprises aluminium profile SG1090 supplied made to measure in silver anodised or white powder coated, alternatively a specified RAL colour. SG 3533 at 14/m and 2 end stops SG 3070 per length. Top fix with SG 3176/3113/ 3115. Wall fix with SG 3176 w. SG Smart Fix at max. 400 mm centres.

### SV

Silent Gliss SG 1090 handdragssystem. Består av aluminiumprofil SG 1090 i specificerad längd i vitlack, alu natur eller angiven RAL färg. 14 st SG 3533 glid per meter samt 2 st SG 3070 vridstopp per system. Takmonteras med fäste SG 3176/3113/3115 c/c 400 mm. Vägghäring med SG 3176 med Smart Fix c/c 400 mm.

### NO

Silent Gliss SG 1090 manuell gardinskinne. Består av aluminiumprofil SG 1080 i spesifisert lengde, standard i hvitlakkert eller alu natur. Kan også leveres i spesifisert RAL farge. 14 stk SG 3533 glidere pr meter, 2 stk SG 3070 stopper pr system. Takmonteres med feste SG 3176/3113/3115 c/c 400 mm. Veggmontering med SG 3176 med Smart Fix c/c 400 mm.

### DA

Silent Gliss SG 1090 håndtrukket gardinskinnesystem. Består af en aluminiumprofil SG1090 i ønsket længde, sølvanodiseret eller hvid pulverlakering, alternativt en specificeret RAL-farve. 14 stk. SG 3533 pr. m og 2 stk. SG 3070 endestop pr. længde. Loftmonteres med SG 3176/3113/ 3115. Vægmonteres med SG 3176 med SG Smart Fix med en afstand på højst 400 mm.

# FITTING

## A. FITTING INFORMATION

For detailed fitting information, visit the Silent Gliss website.

### Fixing points

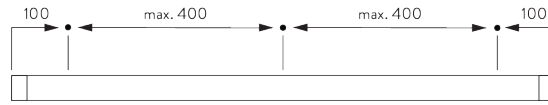

## B. CEILING FITTING

### Bracket SG 3176

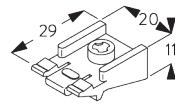
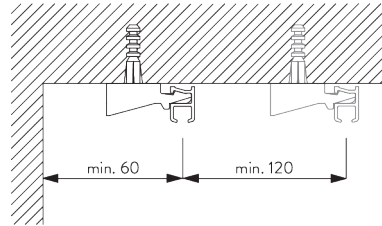

**SG 3176**  
Bracket

### Double ceiling bracket SG 3113 / SG 3115

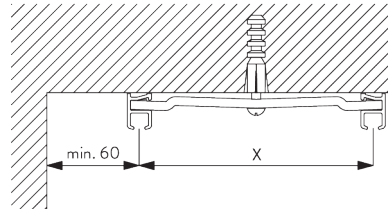

Support	X mm
SG 3113	57
SG 3115	80

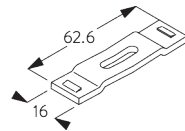

**SG 3113**  
Bracket

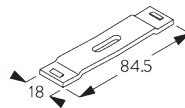

**SG 3115**  
Bracket

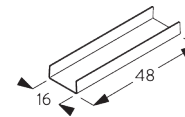

**SG 3255**  
Cover

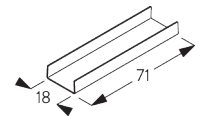

**SG 3256**  
Cover

## C. WALL FITTING

### Bracket SG 3175

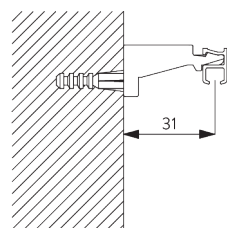

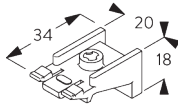

**SG 3175**  
Bracket

**Smart Fix**

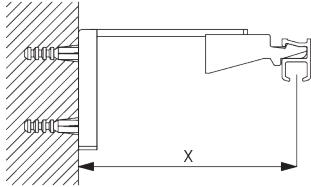

**Smart Fix SG 11200 - SG 11205 and bracket SG 3176:**  
Screw SG 10277 (M4x12) needed.

Smart Fix	X mm
SG 11200 / SG 11210	68
SG 11201 / SG 11211	88
SG 11202 / SG 11212	108
SG 11203 / SG 11213	128
SG 11204 / SG 11214	158
SG 11205 / SG 11215	208

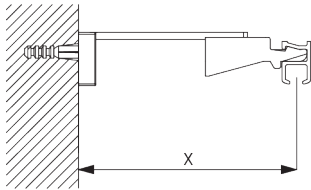

**Square Smart Fix SG 11210 - SG 11215 and bracket SG 3176:**  
Screw SG 10277 (M4x12) needed.

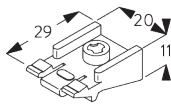

**SG 3176**  
Bracket



**SG 10277**  
Pan head screw M4x12

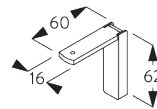

**SG 11200**  
Smart Fix 60 mm

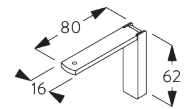

**SG 11201**  
Smart Fix 80 mm

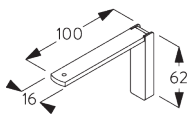

**SG 11202**  
Smart Fix 100 mm

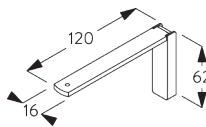

**SG 11203**  
Smart Fix 120 mm

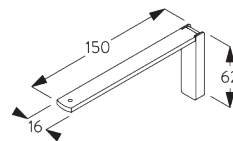

**SG 11204**  
Smart Fix 150 mm

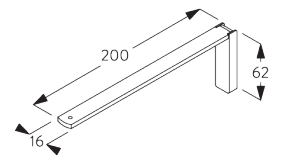

**SG 11205**  
Smart Fix 200 mm

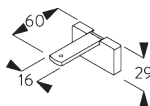

**SG 11210**  
Square Smart Fix 60 mm

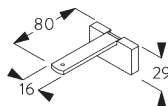

**SG 11211**  
Square Smart Fix 80 mm

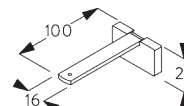

**SG 11212**  
Square Smart Fix 100 mm

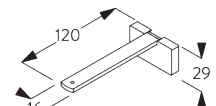

**SG 11213**  
Square Smart Fix 120 mm

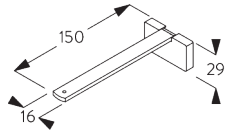

---

**SG 11214**  
*Square Smart Fix 150 mm*

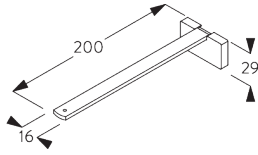





---



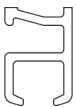

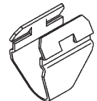









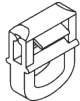

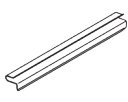

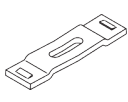

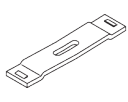
**SG 11215**  
*Square Smart Fix 200 mm*

# PARTS

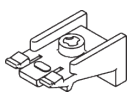
## A. STANDARD PARTS

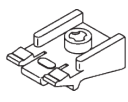
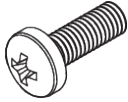
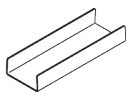
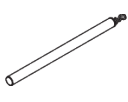
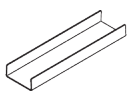
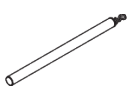
	<b>SG 1090p</b> Profile
	<b>SG 3070</b> End stop
	<b>SG 3085</b> Spring stop
	<b>SG 3533</b> Glider

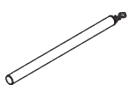
## B. OPTIONAL PARTS

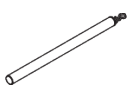
	<b>SG 3016</b> End stop		<b>SG 3535</b> Glider
	<b>SG 3020</b> Hook		<b>SG 3537</b> Glider
	<b>SG 3032</b> Spring stop		<b>SG 3548</b> Glider
	<b>SG 3071</b> End stop		<b>SG 3549</b> Click glider with hook
	<b>SG 3096</b> Connection bridge		<b>SG 3570</b> Glider
	<b>SG 3113</b> Bracket		<b>SG 3571</b> Hook
	<b>SG 3115</b> Bracket		<b>SG 3582</b> Hook
	<b>SG 3151</b> Spacer		<b>SG 3598</b> Eyelet
	<b>SG 3175</b> Bracket		<b>SG 3599</b> Hook
	<b>SG 3176</b> Bracket		<b>SG 10277</b> Pan head screw M4x12
	<b>SG 3255</b> Cover		<b>SG 10430</b> Draw rod 50 cm
	<b>SG 3256</b> Cover		<b>SG 10431</b> Draw rod 75 cm
	<b>SG 3511</b> Glider		<b>SG 10432</b> Draw rod 100 cm
	<b>SG 3534</b> Glider 3533 on strip		<b>SG 10433</b> Draw rod 125 cm



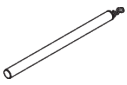

**SG 10434**

Draw rod 150 cm

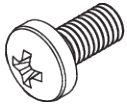

**SG 10492**

Pan head screw M4x8

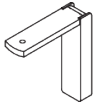

**SG 11200**

Smart Fix 60 mm

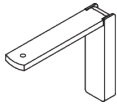

**SG 11201**

Smart Fix 80 mm

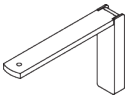

**SG 11202**

Smart Fix 100 mm

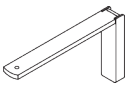

**SG 11203**

Smart Fix 120 mm

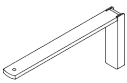

**SG 11204**

Smart Fix 150 mm



**SG 11205**

Smart Fix 200 mm

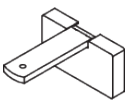

**SG 11210**

Square Smart Fix 60 mm

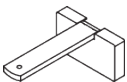

**SG 11211**

Square Smart Fix 80 mm

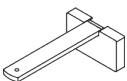

**SG 11212**

Square Smart Fix 100 mm

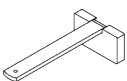

**SG 11213**

Square Smart Fix 120 mm

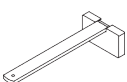

**SG 11214**

Square Smart Fix 150 mm

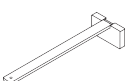

**SG 11215**

Square Smart Fix 200 mm

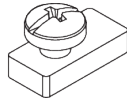

**SG 11335**

End stop



# SG 3600

---

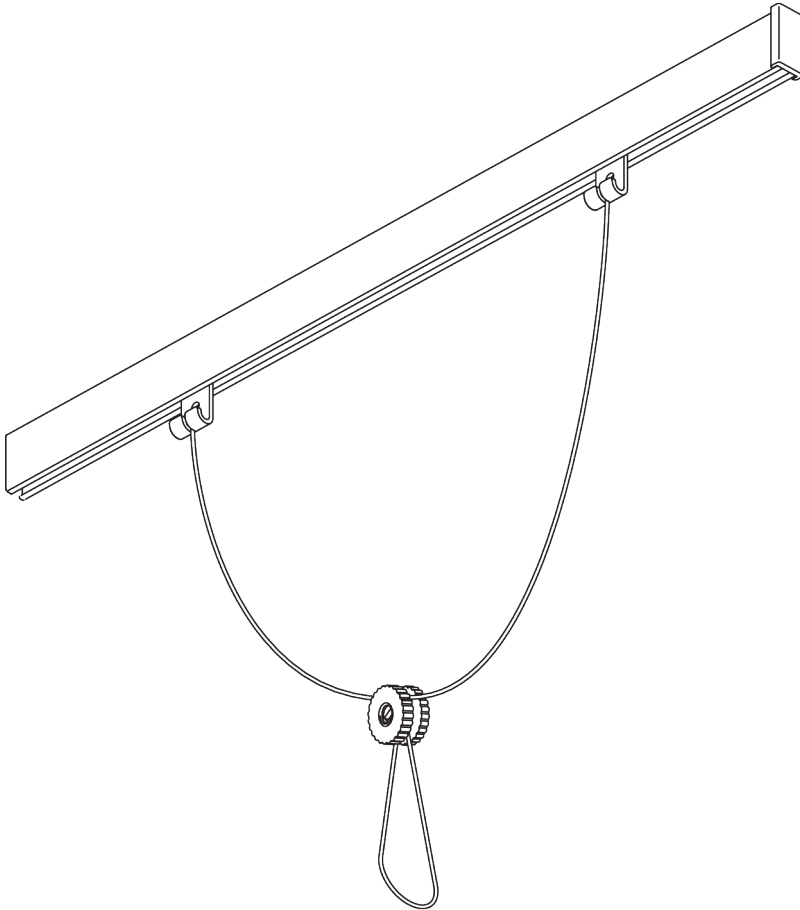
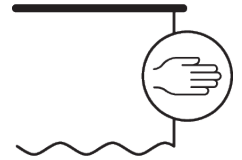

## PRODUCT INFORMATION

- **Operation:** hand
- **Fitting:** wall
- **Colours:** white RAL 9016 or anodised aluminum, special colours possible

### **Features:**

- Picture hanging system
- Adjustable height

# SYSTEM SPECIFICATIONS

## A. SYSTEM DIMENSIONS



10 kg  
(Total picture weight)

## B. PROFILE

Profile and bending  
information

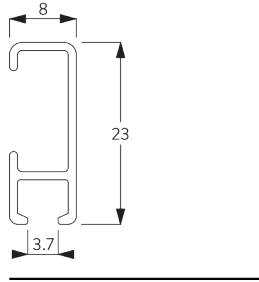

SG 1080p  
Profile

## C. HOW TO MEASURE

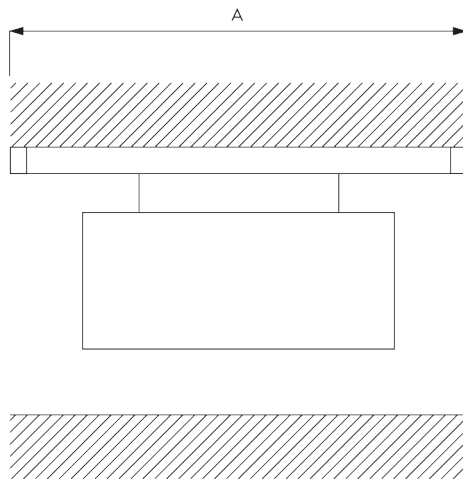

A: System width

## D. SPECIFICATION

### TEXT

#### **EN**

Silent Gliss SG 3600 Picture Hanging System. Comprises aluminium profile SG1080 supplied made to measure in silver anodised or white powder coated, alternatively a specified RAL colour. 2 pcs Endcaps SG 3605 per track. 1 pcs SG Picture hanging set SG 3665 per picture. Wall fix with SG 3606 clip.

#### **SV**

Silent Gliss SG 3600 tavelhängningssystem. Består av aluminiumprofil SG 1080 i specificerad längd i vitlack, alu natur eller angiven RAL färg. 2 st ändskydd SG 3605 per skena. 1 st tavelhängningsset SG 3665 per konstverk. Vägghämontering med SG 3606 klips.

#### **NO**

Silent Gliss SG 3600 Bildeoppengssystem. Består av aluminiumprofil SG 1080 i spesifisert lengde, standard i hvitlakkert eller alu natur. Kan også leveres i spesifisert RAL farge. 2 stk endelokk SG 3605 pr skinne. 1 stk bildeoppengsett SG 3665 pr kunstverk. Veggmontering med SG 3606 klips.

#### **DA**

Silent Gliss SG 3600 billedophængningssystem. Består af en aluminiumprofil SG1080 i ønsket længde, sølvanodiseret eller hvid pulverlakering, alternativt en specificeret RAL-farve. 2 stk. endelåg SG 3605 pr. skinne. 1 stk. SG billedophængningsæt SG 3665 pr. billede. Vægmonteres med SG 3606 klips.

# FITTING

## A. FITTING

### INFORMATION

For detailed fitting information, visit the Silent Gliss website.

#### Fixing Points

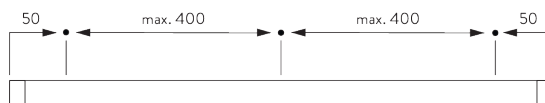

## B. WALL FITTING

### Bracket SG 3606

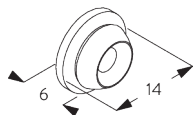
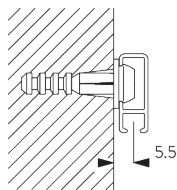

**SG 3606**

Clip

**C. HANGING UP OF  
PICTURE**

Set SG 3665

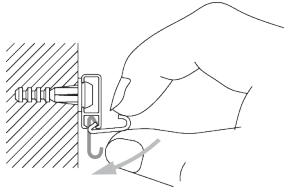

Click-in hooks SG 3606.

Parts:

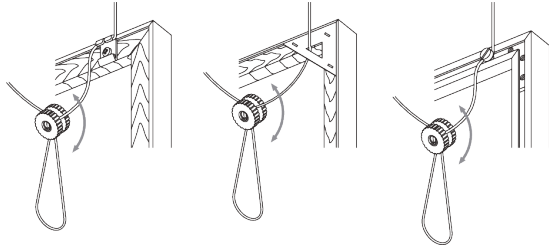

- SG 3634 Height adjuster
- SG 3637 Cord ø 1.5 mm
- SG 3663 Hook



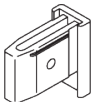

Picture height is adjusted by turning plastic screw.

# PARTS

## A. STANDARD PARTS

	<b>SG 1080p</b> Profile
	<b>SG 3605</b> End cover
	<b>SG 3606</b> Clip
	<b>SG 3665</b> Picture hanging set

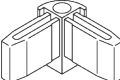
## B. OPTIONAL PARTS

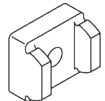
	<b>SG 3604</b> Corner connector
	<b>SG 3657</b> Connection bridge
	<b>SG 3666</b> Clip





# SG 6010

---

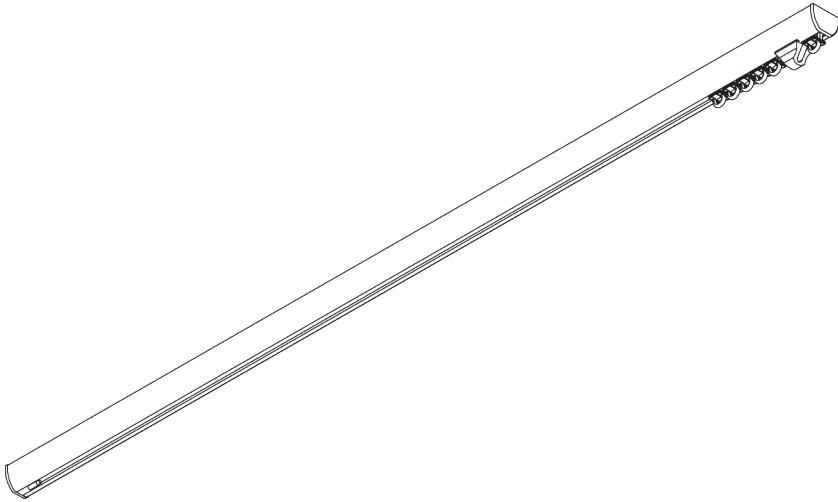

## PRODUCT INFORMATION

- **Operation:** hand
- **Range:** S - M
- **Fitting:** ceiling, wall
- **Colours:** white RAL 9016, black RAL 9005 or anodised aluminum, special colours possible
- **Fabrics:** refer to Silent Gliss fabric collection

### **Features:**

- 2-component (2C) glider technology
- Wave (2C)
- Bendable

# SYSTEM SPECIFICATIONS

## A. PROFILE

Profile and bending information

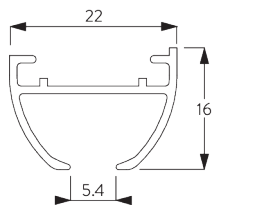

**SG 6010p**

Profile

Radius:  
✓ 15 cm, >25 cm

## B. HOW TO MEASURE

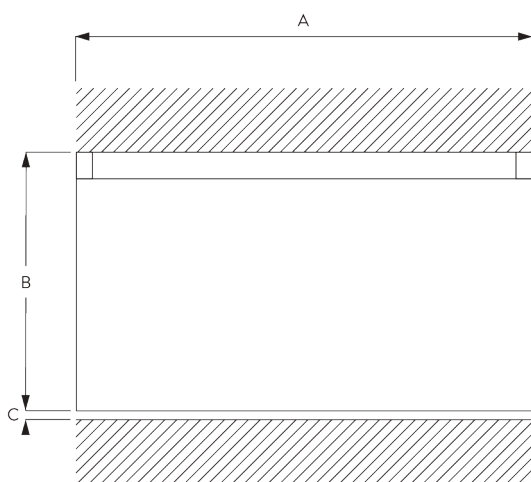

A: System width

B: System height

C: Distance between floor and fabric

## C. SPECIFICATION

TEXT

### EN

Silent Gliss SG 6010 Hand Drawn Curtain Track System. Comprises aluminium profile SG 6010 supplied made to measure in silver anodised or white powder coated, alternatively a specified RAL colour. SG 11300 SILENT TRACK at 14/m and 2 end covers SG 6018 and 2 end stops SG 6065 per length. 2 Top fix with SG 3825. Wall fix with SG 3825 w. SG Smart Fix at max. 500mm centres. Silent Gliss Wave option is available.

### SV

Silent Gliss SG 6010 handdragssystem. Består av aluminiumprofil SG 6010 i specificerad längd i vitlack, alu natur eller angiven RAL färg. 14 st SG 11300 SILENT TRACK glid per meter, 2 st SG 6018 ändskydd samt 2 st SG 6065 vridstopp per system. Takmonteras med fäste SG 3825 c/c 500 mm. Vägmontering med SG 3825 med Smart Fix c/c 500 mm. Kan användas med system Wave.

### NO

Silent Gliss SG 6010 Manuell gardinskinne. Består av aluminiumprofil SG 6010 i spesifisert lengde, standard i hvitlakkert eller alu natur. Kan også leveres i spesifisert RAL farge. 14 stk SG 11300 SILENT TRACK glidere pr. m og 2 stk SG 6018 endeløkk og 2 stk SG6065 stopper pr system. Veggmontering med SG 3825 med Smart Fix c/c 500mm. Kan kombineres med Wave.

### DA

Silent Gliss SG 6010 håndtrukket gardinskinnesystem. Består af en aluminiumprofil SG 6010 i ønsket længde, sølvanodiseret eller hvid pulverlakering, alternativt en specificeret RAL-farve. 14 stk. SG 11300 SILENT TRACK pr. m og 2 stk. SG 6018 endelæg samt 2 stk. SG 6065 endestop pr. længde. Loftmonteres med SG 3825. Vægmonteres med SG 3825 med SG Smart Fix med en afstand på højst 500 mm. Kan bruges med Silent Gliss Wave.

# FITTING

## A. FITTING INFORMATION

For detailed fitting information, visit the Silent Gliss website.

### Fixing points

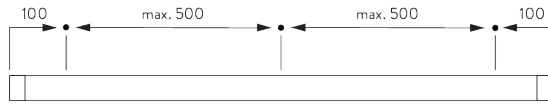

## B. CEILING FITTING

### Clamp SG 3825

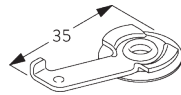
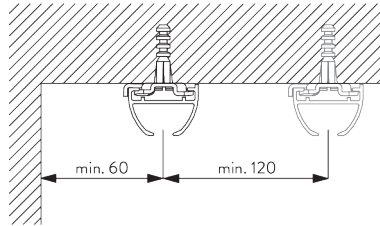

**SG 3825**  
Clamp

### Bracket SG 3832

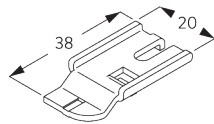
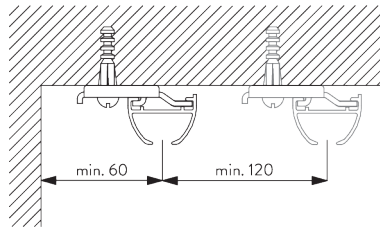

**SG 3832**  
Bracket

## C. WALL FITTING

### Smart Fix

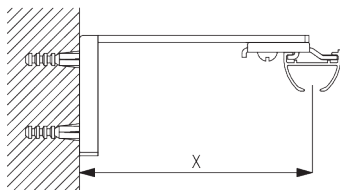

**Smart Fix SG 11200 - SG 11205 and bracket SG 3832:**  
Screw SG 10492 (M4x8) needed.

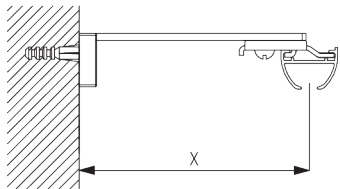

**Square Smart Fix SG 11210 - SG 11215 and bracket SG 3832:**  
Screw SG 10492 (M4x8) needed.

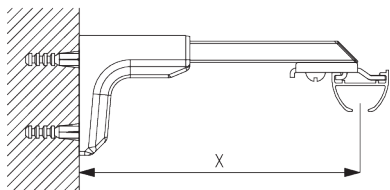

**Universal Smart Fix SG 11154 - SG 11156 and bracket SG 3832:**  
Screw SG 10407 (M4x10) needed.

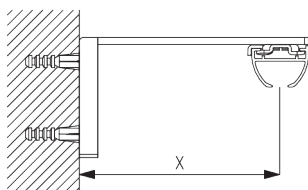

**Smart Fix SG 11200 - SG 11205 and clamp SG 3825:**  
Screw SG 10074 (M4x8) needed.

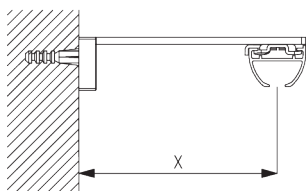

**Square Smart Fix SG 11210 - SG 11215 and clamp SG 3825:**  
Screw SG 10074 (M4x8) needed.

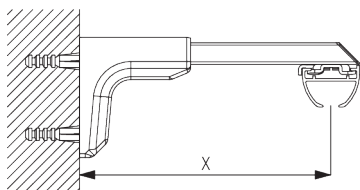

**Universal Smart Fix SG 11154 - SG 11156 and clamp SG 3825:**  
Screw SG 11158 (M4x12) needed.

Smart Fix	X mm (SG 3832)	X mm (SG 3825)
SG 11200 / SG 11210	70	52
SG 11201 / SG 11211	90	72
SG 11202 / SG 11212	110	92
SG 11203 / SG 11213	130	112
SG 11204 / SG 11214	160	142
SG 11205 / SG 11215	210	192
SG 11154	120-148	102-130
SG 11155	150-178	132-160
SG 11156	200-228	182-210

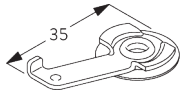

**SG 3825**  
Clamp

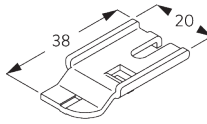

**SG 3832**  
Bracket



**SG 10407**  
Pan head screw M4x10



**SG 10492**  
Pan head screw M4x8



**SG 11158**  
Countersunk head screw  
M4x12

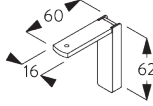

**SG 11200**  
Smart Fix 60 mm

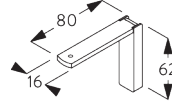

**SG 11201**  
Smart Fix 80 mm

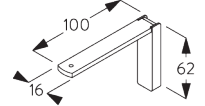

**SG 11202**  
Smart Fix 100 mm

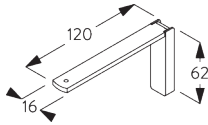

**SG 11203**  
Smart Fix 120 mm

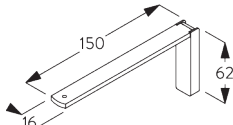

**SG 11204**  
Smart Fix 150 mm

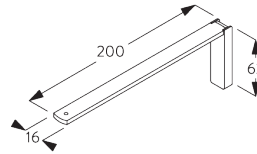

**SG 11205**  
Smart Fix 200 mm

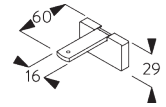

**SG 11210**  
Square Smart Fix 60 mm

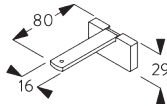

**SG 11211**  
Square Smart Fix 80 mm

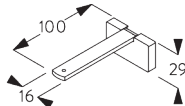

**SG 11212**  
Square Smart Fix 100 mm

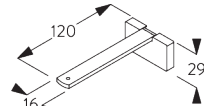

**SG 11213**  
Square Smart Fix 120 mm

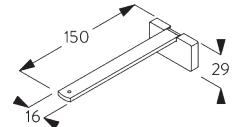

**SG 11214**  
Square Smart Fix 150 mm

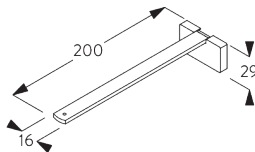

**SG 11215**  
Square Smart Fix 200 mm

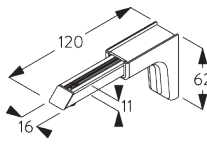

**SG 11154**  
Universal Smart Fix 120 mm

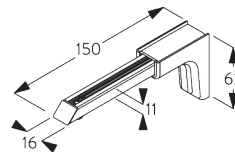

**SG 11155**  
Universal Smart Fix 150 mm

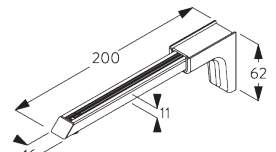

**SG 11156**  
Universal Smart Fix 200 mm

# SYSTEM OPTIONS

## A. WAVE

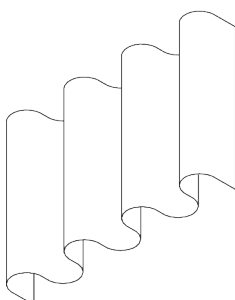

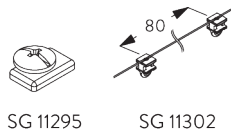

SG 11295

SG 11302

Standard components:

- SG 11295 End stop
- SG 11302 Wave 2C glider cord 80 mm

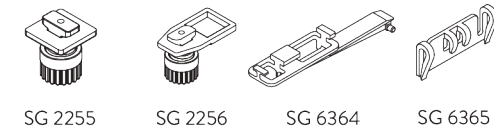

SG 2255

SG 2256

SG 6364

SG 6365

Optional components (min. radius: >25 cm):

- SG 2255 Brake
- SG 2256 Brake
- SG 6364 Wave extension
- SG 6365 Wave hanger
- SG 6366 Wave carrier for draw rod
- SG 10430-34 Draw rod
- SG 11303 Wave 2C glider cord 60 mm



SG 6366

SG 10430-34

SG 11303

Curtain components:

- SG 3582 Hook
- SG 6349 Wave curtain tape
- SG 6363 Wave top hemming tape
- SG 10075 Lead weight 50 gr/m
- SG 10076 Fabric weight

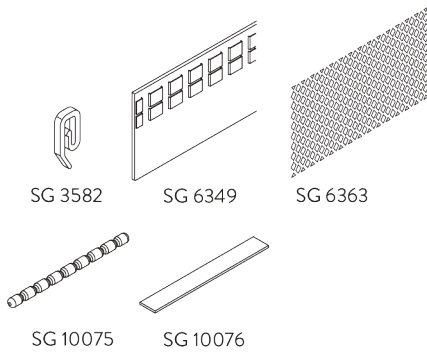

SG 3582

SG 6349

SG 6363

SG 10075

SG 10076

Wave stack depth - 2C glider cord (standard components)

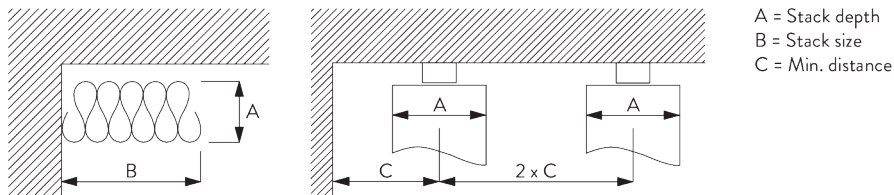



2C Glider cord SG 11302	Pockets between hooks	Approx. curtain fullness	Stack depth A	Stack size B*	Min distance C
80	6	~2.1	140	180 per metre of track	90
80	7	~2.3	160	180 per metre of track	100

2C Glider cord SG 11303	Pockets between hooks	Approx. curtain fullness	Stack depth A	Stack size B*	Min distance C
60	4	~2.1	100	230 per metre of track	70
60	5	~2.3	120	230 per metre of track	80





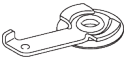
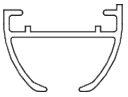
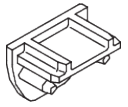

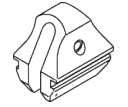
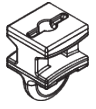



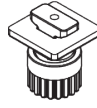
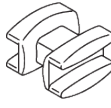
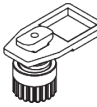





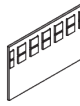
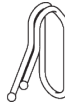
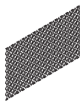

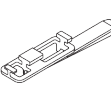
\*Stack size B when using optional extension arm increases by 150 mm per curtain stack!

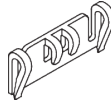
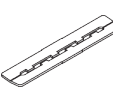
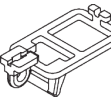
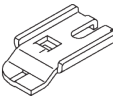
# PARTS

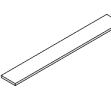
## A. STANDARD PARTS

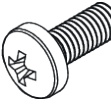
	<b>SG 3599</b> Hook
	<b>SG 3825</b> Clamp
	<b>SG 6010p</b> Profile
	<b>SG 6018</b> End cover
	<b>SG 6065</b> End stop
	<b>SG 6086</b> Spring stop
	<b>SG 11300</b> 2C glider

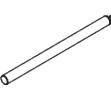
## B. OPTIONAL PARTS

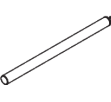
	<b>SG 2255</b> Brake		<b>SG 6082</b> Glider
	<b>SG 2256</b> Brake		<b>SG 6098</b> Roller
	<b>SG 3012</b> Hook		<b>SG 6240</b> Roller
	<b>SG 3020</b> Hook		<b>SG 6283</b> Roller
	<b>SG 3571</b> Hook		<b>SG 6349</b> Wave curtain tape
	<b>SG 3581</b> Hook		<b>SG 6363</b> Wave top hemming tape
	<b>SG 3582</b> Hook		<b>SG 6364</b> Wave extension
	<b>SG 3598</b> Eyelet		<b>SG 6365</b> Wave hanger
	<b>SG 3802</b> Connection bridge		<b>SG 6366</b> Wave carrier for draw rod
	<b>SG 3832</b> Bracket		<b>SG 10075</b> Lead weight 50 g/m
	<b>SG 6005</b> Hook		<b>SG 10076</b> Fabric weight
	<b>SG 6053</b> Spring stop		<b>SG 10407</b> Pan head screw M4x10
	<b>SG 6057</b> Glider		<b>SG 10430</b> Draw rod 50 cm
	<b>SG 6064</b> End stop		<b>SG 10431</b> Draw rod 75 cm

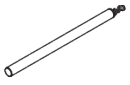

**SG 10432**  
Draw rod 100 cm

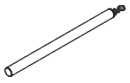

**SG 10433**  
Draw rod 125 cm

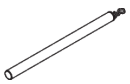

**SG 10434**  
Draw rod 150 cm

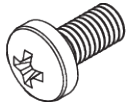

**SG 10492**  
Pan head screw M4x8

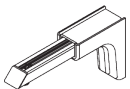

**SG 11154**  
Universal Smart Fix 120 mm

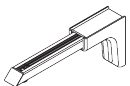

**SG 11155**  
Universal Smart Fix 150 mm

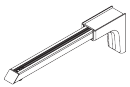

**SG 11156**  
Universal Smart Fix 200 mm

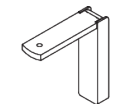

**SG 11200**  
Smart Fix 60 mm

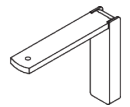

**SG 11201**  
Smart Fix 80 mm

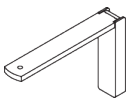

**SG 11202**  
Smart Fix 100 mm

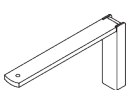

**SG 11203**  
Smart Fix 120 mm

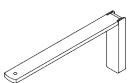

**SG 11204**  
Smart Fix 150 mm

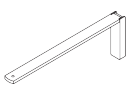

**SG 11205**  
Smart Fix 200 mm

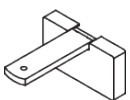

**SG 11210**  
Square Smart Fix 60 mm

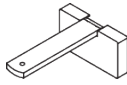

**SG 11211**  
Square Smart Fix 80 mm

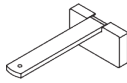

**SG 11212**  
Square Smart Fix 100 mm

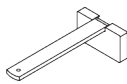

**SG 11213**  
Square Smart Fix 120 mm

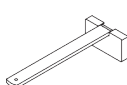

**SG 11214**  
Square Smart Fix 150 mm

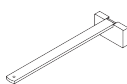

**SG 11215**  
Square Smart Fix 200 mm



**SG 11295**  
End stop



**SG 11301**  
2C glider on strip

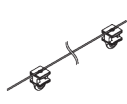

**SG 11302**  
Wave 2C glider cord 80 mm

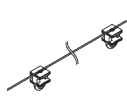

**SG 11303**  
Wave 2C glider cord 60 mm

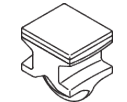

**SG 11305**  
2C glider for direct sewing



# SG 6243

---

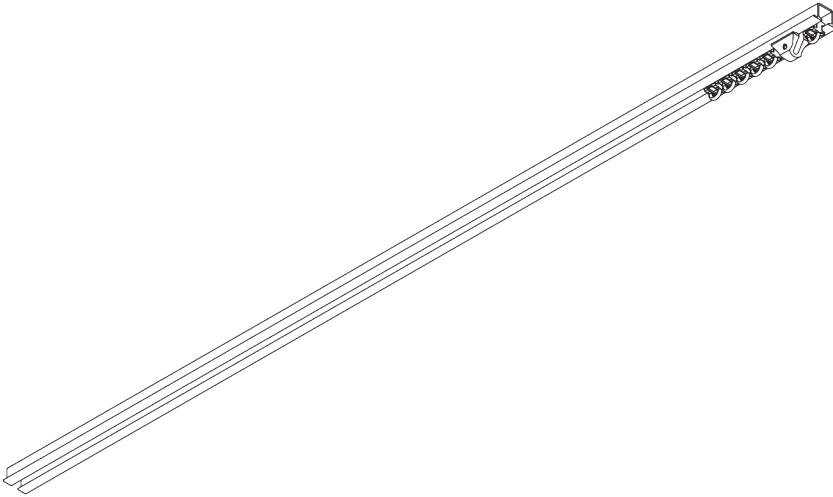

## PRODUCT INFORMATION

- **Operation:** hand
- **Range:** S - M
- **Fitting:** recess
- **Colours:** white RAL 9016 or anodised aluminum, special colours possible
- **Fabrics:** refer to Silent Gliss fabric collection

### **Features:**

- 2-component (2C) glider technology
- Wave (2C)
- Bendable
- Pre-drilled profile

# SYSTEM SPECIFICATIONS

## A. PROFILE

Profile and bending information

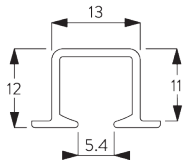

SG 6243p

Profile

Radius:  
20 cm, >25 cm

## B. HOW TO MEASURE

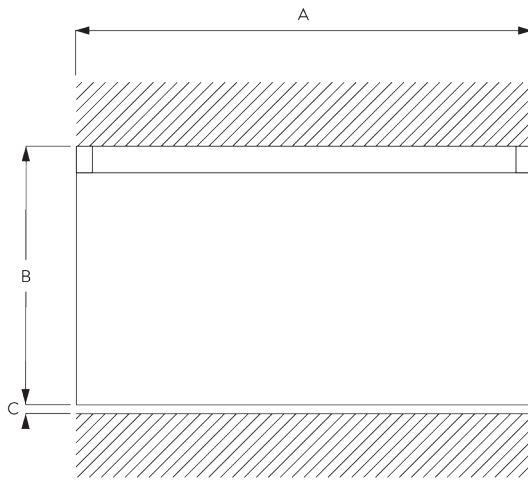

A: System width  
B: System height  
C: Distance between floor and fabric

## C. SPECIFICATION TEXT

### EN

Silent Gliss SG 6243 Hand Drawn Curtain Track System for recessed fitting. Comprises aluminium profile SG 6243 supplied made to measure in silver anodised or white powder coated, alternatively a specified RAL colour. SG 11300 SILENT TRACK at 14/m and 2 end stops SG 6065/Spring Stops SG 6086 per length. Top fix to ceiling with screws at max. 240 mm centres. Silent Gliss Wave option is available.

### SV

Silent Gliss SG 6243 handdragssystem för infällning. Består av aluminiumprofil SG 6243 i specificerad längd i vitlack, alu natur eller angiven RAL färg. 14 st SG 11300 SILENT TRACK glid per meter, samt 2 st SG 6065 vridstopp / Fjäder SG 6086 per system. Takmonteras med skruv c/c 240 mm. Kan användas med system Wave.

### NO

Silent Gliss SG 6243 Manuell gardinskinne for innfelling. Består av aluminiumprofil SG 6243 i spesifisert lengde, standard i hvitlakkert eller alu natur. Kan også leveres i spesifisert RAL farge. 14 stk SG 11300 SILENT TRACK glidere pr meter, 2 stk SG 6065 stopper og 2 stk SG 6086 fjær pr system. Takmonteres med skruer c/c 240mm. Kan kombineres med Wave.

### DA

Silent Gliss SG 6243 håndtrukket gardinskinnesystem til indfældning. Består af en aluminiumprofil SG 6243 i ønsket længde, sølvanodiseret eller hvid pulverlakering, alternativt en specificeret RAL-farve. 14 stk. SG 11300 SILENT TRACK pr. m og 2 stk. SG 6065 endestop eller SG 6086 fjeder pr. længde. Fastgøres i loftet med skruer med højst 240 mm afstand. Kan bruges med Silent Gliss Wave.

# FITTING

## A. FITTING INFORMATION

For detailed fitting information, visit the Silent Gliss website.

### Fixing points

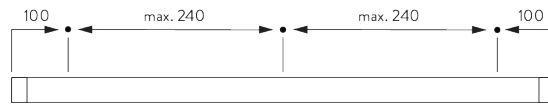

## B. RECESS FITTING

### Direct into wood

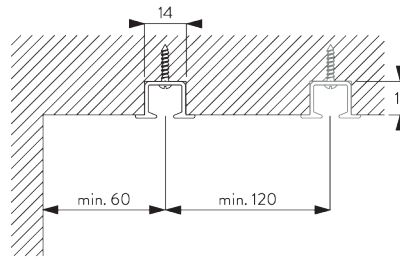

Recess channel: 11 x 14 mm

# SYSTEM OPTIONS

## A. WAVE

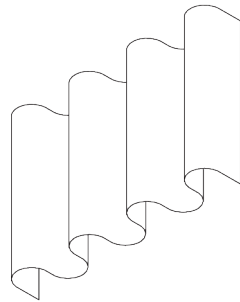

SG 11295

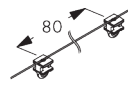

SG 11302

Standard components:

- SG 11295 End stop
- SG 11302 Wave 2C glider cord 80 mm

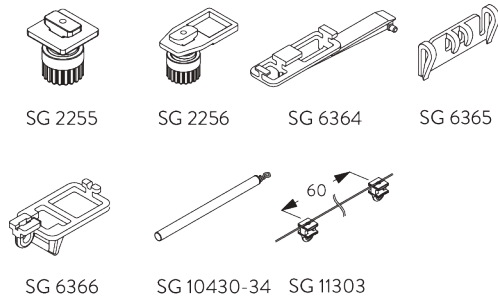

Optional components (min. radius >25 cm):

- SG 2255 Brake
- SG 2256 Brake
- SG 6364 Wave extension
- SG 6365 Wave hanger
- SG 6366 Wave carrier for draw rod
- SG 10430-34 Draw rod
- SG 11303 Wave 2C glider cord 60 mm

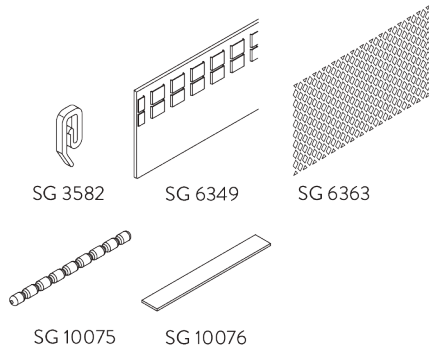

Curtain components:

- SG 3582 Hook
- SG 6349 Wave curtain tape
- SG 6363 Wave top hemming tape
- SG 10075 Lead weight 50 gr/m
- SG 10076 Fabric weight

Wave stack depth - 2C glider cord (standard components)

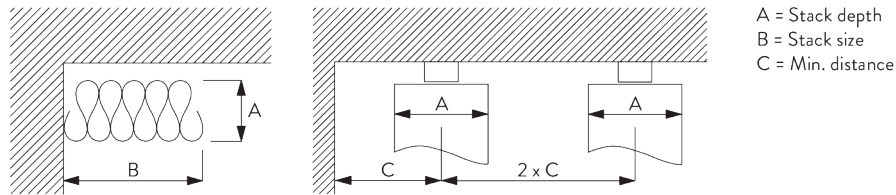

A = Stack depth  
B = Stack size  
C = Min. distance







2C Glider cord SG 11302	Pockets between hooks	Approx. curtain fullness	Stack depth A	Stack size B*	Min distance C
80	6	~2.1	140	180 per metre of track	90
80	7	~2.3	160	180 per metre of track	100

2C Glider cord SG 11303	Pockets between hooks	Approx. curtain fullness	Stack depth A	Stack size B*	Min distance C
60	4	~2.1	100	230 per metre of track	70
60	5	~2.3	120	230 per metre of track	80









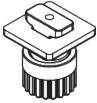
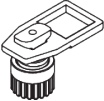

\*Stack size B when using optional extension arm increases by 150 mm per curtain!

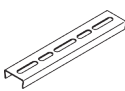

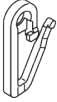



# PARTS

## A. STANDARD PARTS

	<b>SG 3599</b> Hook
	<b>SG 6065</b> End stop
	<b>SG 6086</b> Spring stop
	<b>SG 6243p</b> Profile
	<b>SG 10717</b> Countersunk head screw 2.2x19
	<b>SG 11300</b> 2C glider

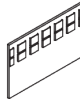
## B. OPTIONAL PARTS

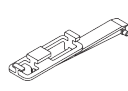
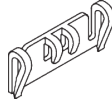
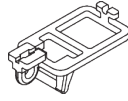
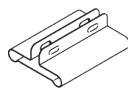
	<b>SG 2255</b> Brake
	<b>SG 2256</b> Brake
	<b>SG 3012</b> Hook
	<b>SG 3020</b> Hook
	<b>SG 3067</b> Connection bridge
	<b>SG 3571</b> Hook
	<b>SG 3582</b> Hook
	<b>SG 3598</b> Eyelet
	<b>SG 6053</b> Spring stop
	<b>SG 6057</b> Glider
	<b>SG 6064</b> End stop
	<b>SG 6082</b> Glider
	<b>SG 6094</b> Roller
	<b>SG 6098</b> Roller

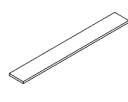
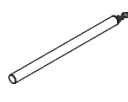
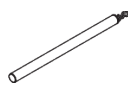
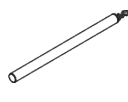
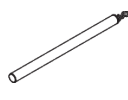
	<b>SG 6240</b> Roller
	<b>SG 6283</b> Roller
	<b>SG 6349</b> Wave curtain tape
	<b>SG 6363</b> Wave top hemming tape
	<b>SG 6364</b> Wave extension
	<b>SG 6365</b> Wave hanger
	<b>SG 6366</b> Wave carrier for draw rod
	<b>SG 7002</b> Profile protector
	<b>SG 10075</b> Lead weight 50 g/m
	<b>SG 10076</b> Fabric weight
	<b>SG 10430</b> Draw rod 50 cm
	<b>SG 10431</b> Draw rod 75 cm
	<b>SG 10432</b> Draw rod 100 cm
	<b>SG 10433</b> Draw rod 125 cm

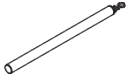

---

**SG 10434**

*Draw rod 150 cm*

---

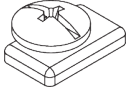

---

**SG 11295**

*End stop*

---



---

**SG 11301**

*2C glider on strip*

---

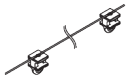

---

**SG 11302**

*Wave 2C glider cord 80 mm*

---

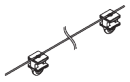

---

**SG 11303**

*Wave 2C glider cord 60 mm*

---

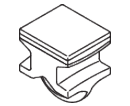

---

**SG 11305**

*2C glider for direct sewing*

---

# SG 6250

---

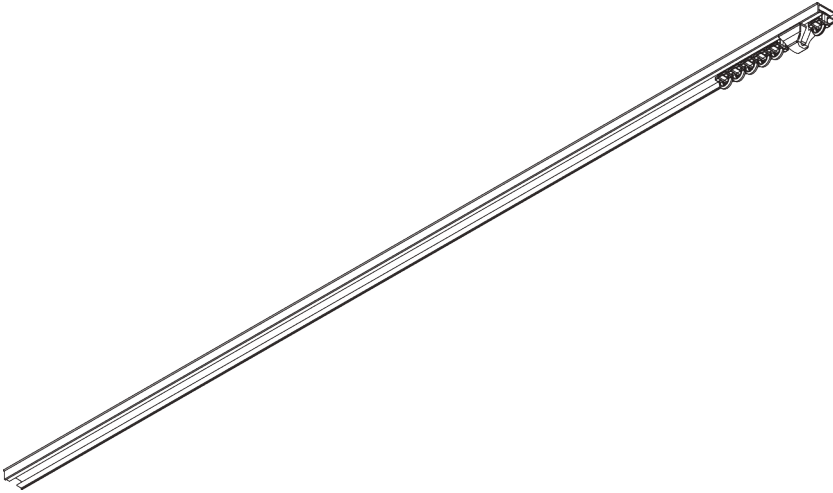

## PRODUCT INFORMATION

- **Operation:** hand
- **Range:** S - M
- **Fitting:** recess
- **Colours:** white RAL 9016
- **Fabrics:** refer to Silent Gliss fabric collection

### **Features:**

- 2-component (2C) glider technology
- Wave (2C)
- Bendable

# SYSTEM SPECIFICATIONS

## A. PROFILE

Profile and bending information

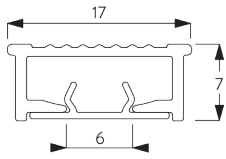

**SG 11220**

Profile with cover

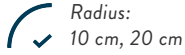

## B. HOW TO MEASURE

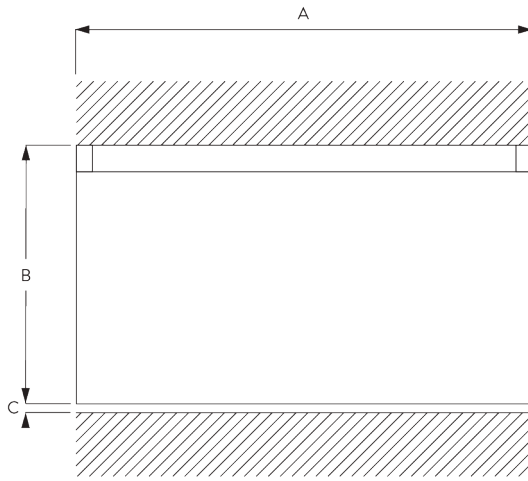

A: System width

B: System height

C: Distance between floor and fabric

## C. SPECIFICATION TEXT

### EN

Silent Gliss SG 6250 Hand Drawn Curtain Track System for recessed fitting. Comprises aluminium profile SG 11220 supplied made to measure in white powder coated, SG 11300 SILENT TRACK at 14/m and 2 Spring Stops SG 6245 per length. Top fix to ceiling with glue. Silent Gliss Wave option is available.

### SV

Silent Gliss SG 6250 handdragssystem för infällning. Består av aluminiumprofil SG 11220 i specificerad längd i vitlack. 14 st SG 11300 SILENT TRACK glid per meter samt 2 st SG 6245 fjäder per system. Takmonteras med bygglim. Kan användas med system Wave.

### NO

Silent Gliss SG 6250 Manuell gardinskinne for innfelling. Består av aluminiumprofil SG 11220 i spesifisert hvitlakkert lengde. 14 stk SG 11300 SILENT TRACK glide per meter, 2 stk SG 6245 fjær pr system. Takmonteres med bygglim. Kan brukes med Wave system.

### DA

Silent Gliss SG 6250 håndtrukket gardinskinnesystem til indfældning. Består af aluminiumprofil SG 11220 i ønsket længde, hvid pulverlakering. 14 stk. SG 11300 SILENT TRACK pr. m og 2 stk. SG 6245 fjeder pr. længde. Fastgøres i loftet med lim. Kan bruges med Silent Gliss Wave.



# FITTING

## A. FITTING INFORMATION

For detailed fitting information, visit the Silent Gliss website, login section.

## B. RECESS FITTING

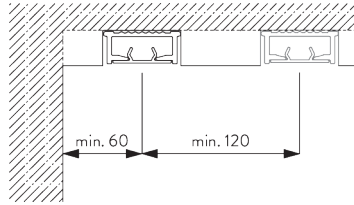

Adhesive assembly exclusively on raw concrete.

# SYSTEM OPTIONS

## A. WAVE

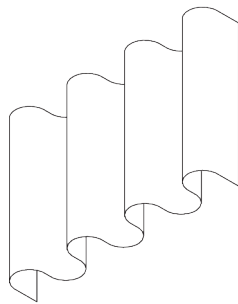

SG 11295

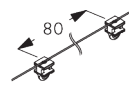

SG 11302

Standard components:

- SG 11295 End stop
- SG 11302 Wave 2C glider cord 80 mm

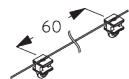

SG 11303

Optional components:

- SG 11303 Wave 2C glider cord 60 mm

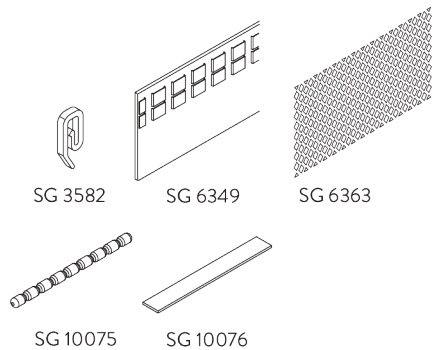

**Curtain components:**

- SG 3582 Hook
- SG 6349 Wave curtain tape
- SG 6363 Wave top hemming tape
- SG 10075 Lead weight 50 gr/m
- SG 10076 Fabric weight

**Wave stack depth - 2C glider cord (standard components)**

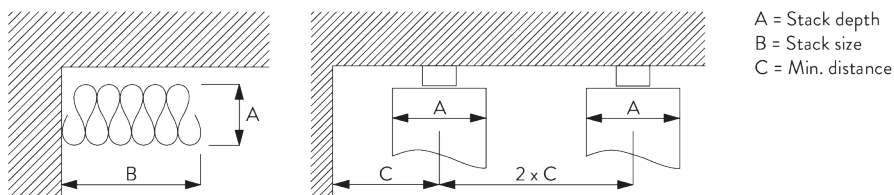





A = Stack depth  
 B = Stack size  
 C = Min. distance

2C Glider cord SG 11302	Pockets between hooks	Approx. curtain fullness	Stack depth A	Stack size B*	Min distance C
80	6	~2.1	140	180 per metre of track	90
80	7	~2.3	160	180 per metre of track	100





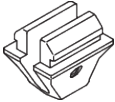
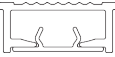



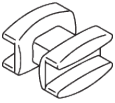

2C Glider cord SG 11303	Pockets between hooks	Approx. curtain fullness	Stack depth A	Stack size B*	Min distance C
60	4	~2.1	100	230 per metre of track	70
60	5	~2.3	120	230 per metre of track	80

# PARTS

## A. STANDARD PARTS

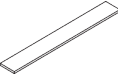
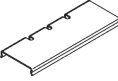
	<b>SG 3599</b> Hook
	<b>SG 6065</b> End stop
	<b>SG 6245</b> Spring stop
	<b>SG 11220</b> Profile with cover
	<b>SG 11300</b> 2C glider

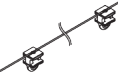
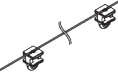
## B. OPTIONAL PARTS

	<b>SG 3012</b> Hook
	<b>SG 3582</b> Hook
	<b>SG 6057</b> Glider
	<b>SG 6082</b> Glider
	<b>SG 6349</b> Wave curtain tape
	<b>SG 6363</b> Wave top hemming tape
	<b>SG 10075</b> Lead weight 50 g/m
	<b>SG 10076</b> Fabric weight
	<b>SG 11222</b> Connector
	<b>SG 11295</b> End stop
	<b>SG 11301</b> 2C glider on strip
	<b>SG 11302</b> Wave 2C glider cord 80 mm
	<b>SG 11303</b> Wave 2C glider cord 60 mm
	<b>SG 11305</b> 2C glider for direct sewing



# SG 6293

---

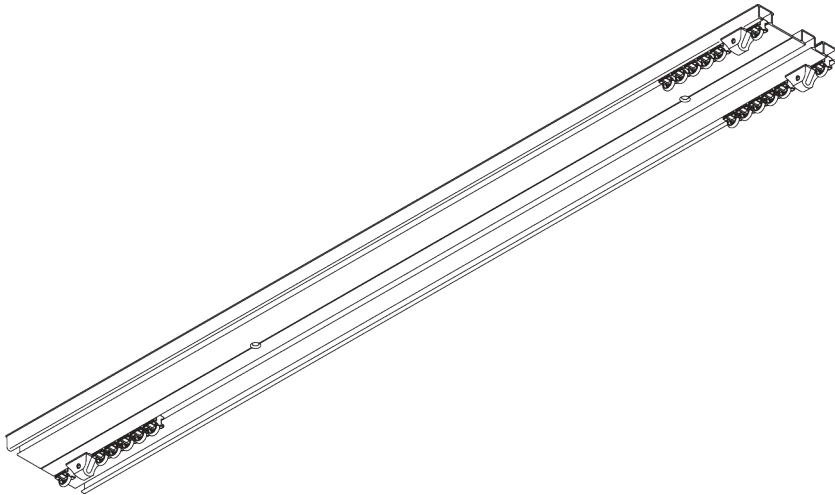
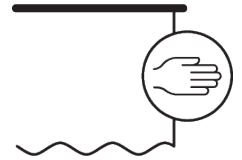

## PRODUCT INFORMATION

- **Operation:** hand
- **Range:** M - L
- **Fitting:** ceiling
- **Colours:** white RAL 9016 or anodised aluminum, special colours possible
- **Fabrics:** refer to Silent Gliss fabric collection

### **Features:**

- 2-component (2C) glider technology
- Pre-drilled profile

# SYSTEM SPECIFICATIONS

## A. PROFILE

### Profile information

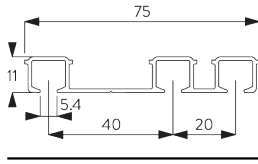

SG 6293p

Profile

## B. HOW TO MEASURE

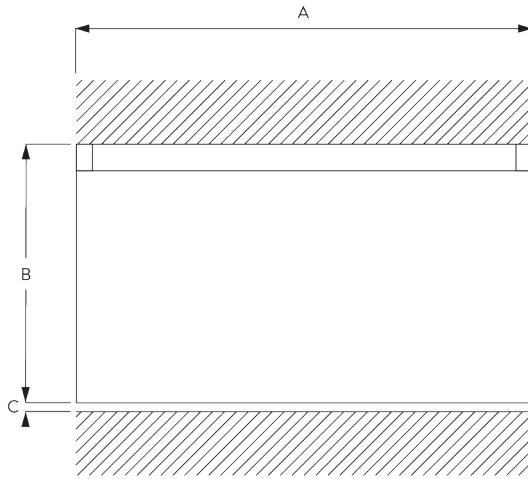

A: System width

B: System height

C: Distance between floor and fabric

## C. SPECIFICATION

### TEXT

#### EN

Silent Gliss SG 6293 Hand Drawn Curtain Track System for recessed fitting. Comprises aluminium profile SG 6293 supplied made to measure in silver anodised or white powder coated, alternatively a specified RAL colour. SG 11300 SILENT TRACK at 14/m/track and 6 SG 6065 End stops / SG 6086 Spring Stops per length. Top fix to ceiling with screws at max. 400 mm centres.

#### SV

Silent Gliss SG 6293 handdragssystem för infällning. Består av aluminiumprofil SG 6293 i specificerad längd i vitlack, alu natur eller angiven RAL färg. 14 st SG 11300 SILENT TRACK glid per meter/spår samt 6 st SG 6065 vridstopp / SG 6086 fjäder per system. Takmonteras med skruv c/c 400 mm.

#### NO

Silent Gliss SG 6293 Manuell gardinskinne for innfelling. Består av aluminiumprofil SG 6293 i spesifisert lengde, standard i hvitlakkert eller alu natur. Kan også leveres i spesifisert RAL farge. 14 stk SG 11300 SILENT TRACK glidere pr meter/spor, 6 stk SG 6065 vristopp/SG 6086 fjær pr system. Takmonteres med skruer c/c 400 mm.

#### DA

Silent Gliss SG 6293 håndtrukket gardinskinnesystem til indfældning. Består af en aluminiumprofil SG 6293 i ønsket længde, sølvanodiseret eller hvid pulverlakering, alternativt en specificeret RAL-farve. 14 stk. SG 11300 SILENT TRACK pr. m/skinne og 6 stk. SG 6065 endestop eller SG 6086 fjeder pr. længde. Fastgøres i loftet med skruer med højst 400 mm afstand.

# FITTING

## A. FITTING INFORMATION

For detailed fitting information, visit the *Silent Gliss* website.

### Fixing points

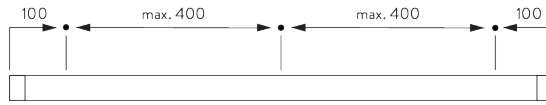



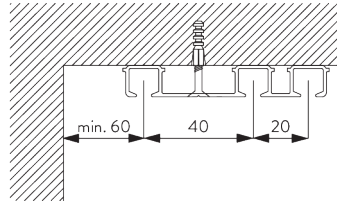

## B. CEILING FITTING

### Direct fitting





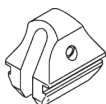

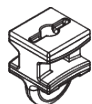





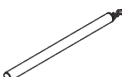
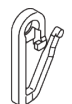

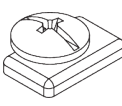
# PARTS

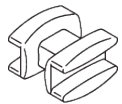
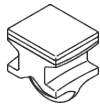
## A. STANDARD PARTS

	<b>SG 3599</b> Hook
	<b>SG 6065</b> End stop
	<b>SG 6086</b> Spring stop
	<b>SG 6293p</b> Profile
	<b>SG 11300</b> 2C glider

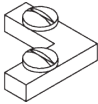
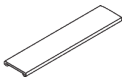
## B. OPTIONAL PARTS

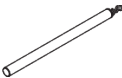
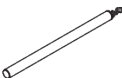
	<b>SG 3012</b> Hook		<b>SG 10432</b> Draw rod 100 cm
	<b>SG 3581</b> Hook		<b>SG 10433</b> Draw rod 125 cm
	<b>SG 3598</b> Eyelet		<b>SG 10434</b> Draw rod 150 cm
	<b>SG 6053</b> Spring stop		<b>SG 11295</b> End stop
	<b>SG 6057</b> Glider		<b>SG 11301</b> 2C glider on strip
	<b>SG 6082</b> Glider		<b>SG 11305</b> 2C glider for direct sewing
	<b>SG 6094</b> Roller		
	<b>SG 6098</b> Roller		
	<b>SG 6240</b> Roller		
	<b>SG 6246</b> Corner connection		
	<b>SG 6269</b> Connection bridge		
	<b>SG 6283</b> Roller		
	<b>SG 10430</b> Draw rod 50 cm		
	<b>SG 10431</b> Draw rod 75 cm		



# SG 6380

---

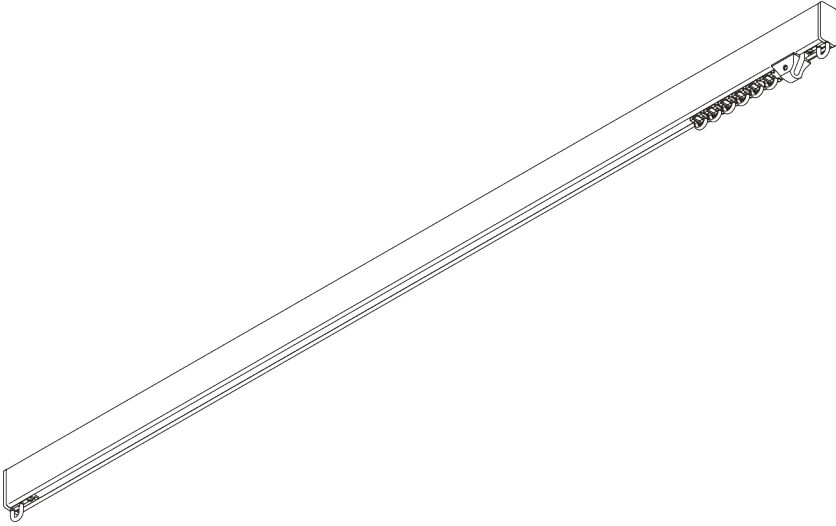

## PRODUCT INFORMATION

- **Operation:** hand
- **Range:** M - L
- **Fitting:** ceiling, wall
- **Colours:** white RAL 9016 or anodised aluminum, special colours possible
- **Fabrics:** refer to Silent Gliss fabric collection

### **Features:**

- 2-component (2C) glider technology
- Wave (2C)
- Bendable

# SYSTEM SPECIFICATIONS

## A. PROFILE

Profile and bending information

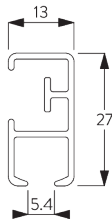

**SG 6380p**

Profile

 Radius:  
10 cm, >25 cm

## B. HOW TO MEASURE

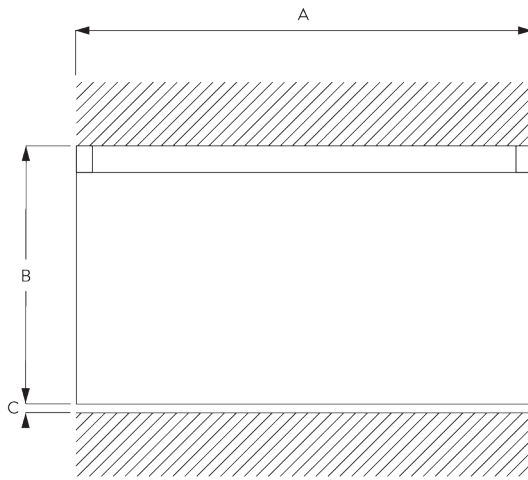

A: System width  
B: System height  
C: Distance between floor and fabric

## C. SPECIFICATION TEXT

### EN

Silent Gliss SG 6380 Hand Drawn Curtain Track System. Comprises aluminium profile SG 6380 supplied made to measure in silver anodised or white powder coated, alternatively a specified RAL colour. SG 11130 at 14/m and 2 end covers SG 6381. Top fixed with brackets SG 3603 at max. 600 mm centres / wall fix SG Smart Fix at max. 600 mm centres. Silent Gliss Wave option is available.

### SV

Silent Gliss SG 6380 handdragssystem. Består av aluminiumprofil SG 6380 i specificerad längd i vitlack, alu natur eller angiven RAL färg. 14 st SG 11300 SILENT TRACK glid per meter, 2 st SG 6381 ändskydd per system. Takmonteras med fäste SG 3603 c/c 600 mm. Vägghängning med SG 3603 och Smart Fix c/c 600 mm. Kan användas med system Wave.

### NO

Silent Gliss SG 6380 Manuell gardinskinne. Består av aluminiumprofil SG 6380 i spesifisert lengde, standard i hvitlakkert eller alu natur. Kan også leveres i spesifisert RAL farge. 14 stk SG 11300 SILENT TRACK glidere pr meter, 2 stk SG 6381 endelokk pr system. Takmonteres med feste 3603 c/c 600 mm. Veggmontering med SG 3603 og smart Fix c/c 600 mm. Kan benyttes med Wave system.

### DA

Silent Gliss SG 6380 håndtrukket gardinskinnesystem. Består af en aluminiumprofil SG 6380 i ønsket længde, sølvanodiseret eller hvid pulverlakering, alternativt en specificeret RAL-farve. 14 stk. SG 11130 pr. m og 2 stk. SG 6381 endelæg. Loftmonteres med beslagene SG 3603 med højst 600 mm afstand. Vægmonteres med SG Smart Fix med højst 600 mm afstand Kan bruges med Silent Gliss Wave.

# FITTING

## A. FITTING INFORMATION

For detailed fitting information, visit the Silent Gliss website.

### Fixing points

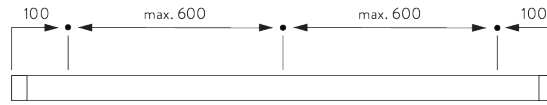

## B. CEILING FITTING

### Bracket SG 3603

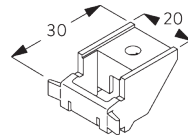
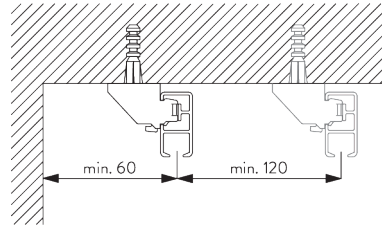

**SG 3603**  
Bracket

## C. WALL FITTING

### Smart Fix

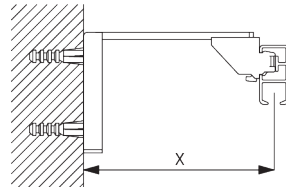

**Smart Fix SG 11200 - SG 11205 and bracket SG 3603:**  
Screw SG 10492 (M4x8) needed.

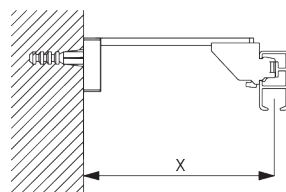

**Square Smart Fix SG 11210 - SG 11215 and bracket SG 3603:**  
Screw SG 10492 (M4x8) needed.

Smart Fix	X mm
SG 11200 / SG 11210	72
SG 11201 / SG 11211	92
SG 11202 / SG 11212	112
SG 11203 / SG 11213	132
SG 11204 / SG 11214	162
SG 11205 / SG 11215	212
SG 11154	122-150
SG 11155	152-180
SG 11156	202-230

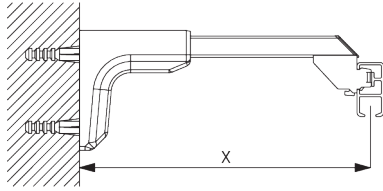

**Universal Smart Fix SG 11154 - SG 11156 and  
bracket SG 3603:**

Screw SG 10277 (M4x12) needed.

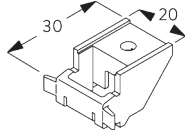

**SG 3603**

Bracket



**SG 10277**

Pan head screw M4x12



**SG 10492**

Pan head screw M4x8

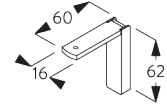

**SG 11200**

Smart Fix 60 mm

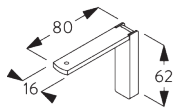

**SG 11201**

Smart Fix 80 mm

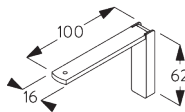

**SG 11202**

Smart Fix 100 mm

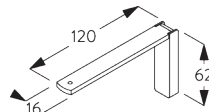

**SG 11203**

Smart Fix 120 mm

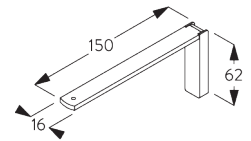

**SG 11204**

Smart Fix 150 mm

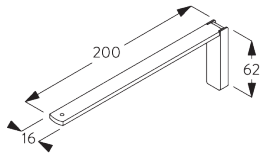

**SG 11205**

Smart Fix 200 mm

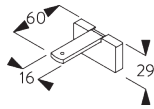

**SG 11210**

Square Smart Fix 60 mm

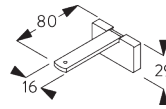

**SG 11211**

Square Smart Fix 80 mm

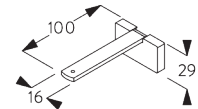

**SG 11212**

Square Smart Fix 100 mm

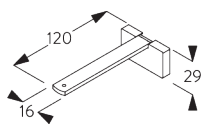

**SG 11213**

Square Smart Fix 120 mm

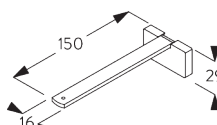

**SG 11214**

Square Smart Fix 150 mm

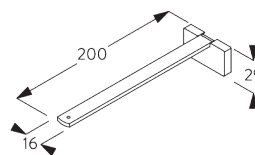

**SG 11215**

Square Smart Fix 200 mm

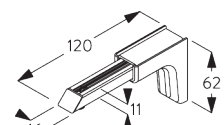

**SG 11154**

Universal Smart Fix 120 mm

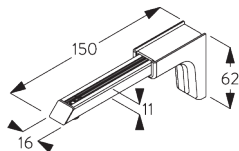

**SG 11155**

Universal Smart Fix 150 mm

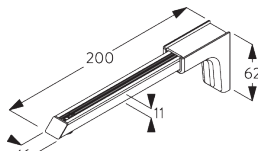

**SG 11156**

Universal Smart Fix 200 mm

**Universal Brackets  
SG 3630, SG 3655,  
SG 3660**

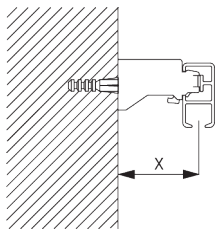

<b>Bracket</b>	<b>X mm</b>
SG 3630	35
SG 3655	50
SG 3660	65

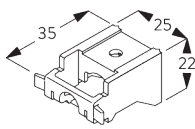

**SG 3630**  
Bracket 35 mm

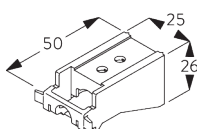

**SG 3655**  
Bracket 50 mm

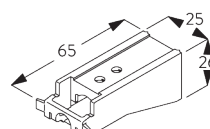

**SG 3660**  
Bracket 65 mm

# SYSTEM OPTIONS

## A. WAVE

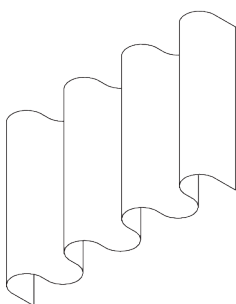

SG 11295

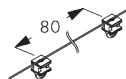

SG 11302

Standard components:

- SG 11295 End stop
- SG 11302 Wave 2C glider cord 80 mm



SG 2255



SG 2256

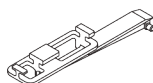

SG 6364



SG 6365

Optional components (min. radius >25 cm):

- SG 2255 Brake
- SG 2256 Brake
- SG 6364 Wave extension
- SG 6365 Wave hanger
- SG 6366 Wave carrier for draw rod
- SG 10430-34 Draw rod
- SG 11303 Wave 2C glider cord 60 mm

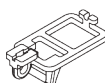

SG 6366

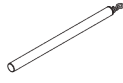

SG 10430-34

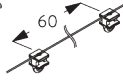

SG 11303

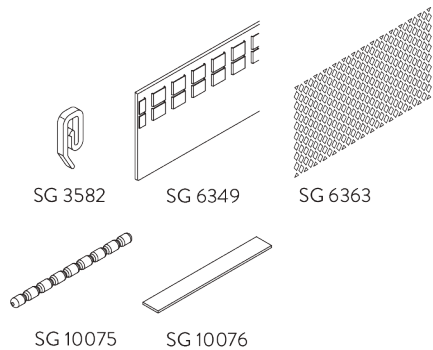

Curtain components:

- SG 3582 Hook
- SG 6349 Wave curtain tape
- SG 6363 Wave top hemming tape
- SG 10075 Lead weight 50 gr/m
- SG 10076 Fabric weight

Wave stack depth - 2C glider cord (standard components)

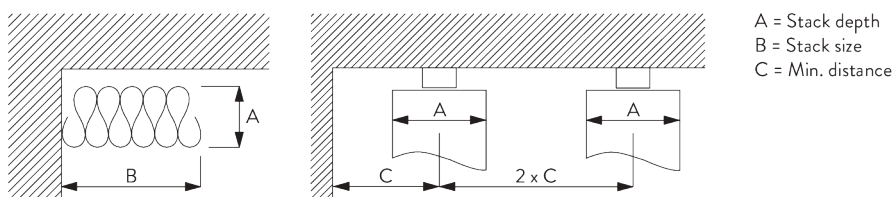





2C Glider cord SG 11302	Pockets between hooks	Approx. curtain fullness	Stack depth A	Stack size B*	Min distance C
80	6	~2.1	140	180 per metre of track	90
80	7	~2.3	160	180 per metre of track	100

2C Glider cord SG 11303	Pockets between hooks	Approx. curtain fullness	Stack depth A	Stack size B*	Min distance C
60	4	~2.1	100	230 per metre of track	70
60	5	~2.3	120	230 per metre of track	80



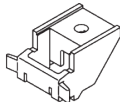

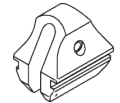
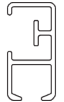
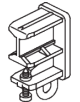





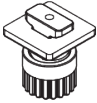

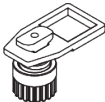



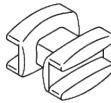

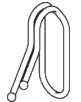

\*Stack size B when using optional extension arm increases by 150 mm per curtain stack!

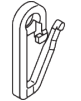
# PARTS

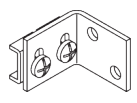
## A. STANDARD PARTS

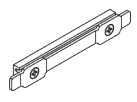
	<b>SG 3599</b> Hook
	<b>SG 3603</b> Bracket
	<b>SG 6065</b> End stop
	<b>SG 6086</b> Spring stop
	<b>SG 6380p</b> Profile
	<b>SG 6381</b> End cover
	<b>SG 11300</b> 2C glider

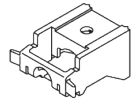
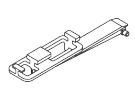
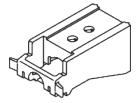
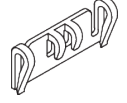
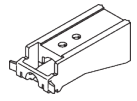
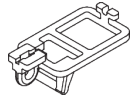
## B. OPTIONAL PARTS

	<b>SG 2255</b> Brake		<b>SG 6005</b> Hook
	<b>SG 2256</b> Brake		<b>SG 6053</b> Spring stop
	<b>SG 3012</b> Hook		<b>SG 6057</b> Glider
	<b>SG 3555</b> Hook		<b>SG 6082</b> Glider
	<b>SG 3571</b> Hook		<b>SG 6094</b> Roller
	<b>SG 3581</b> Hook		<b>SG 6098</b> Roller
	<b>SG 3582</b> Hook		<b>SG 6240</b> Roller
	<b>SG 3598</b> Eyelet		<b>SG 6283</b> Roller
	<b>SG 3618</b> Wall bracket		<b>SG 6349</b> Wave curtain tape
	<b>SG 3620</b> Connection bridge		<b>SG 6363</b> Wave top hemming tape
	<b>SG 3630</b> Bracket 35 mm		<b>SG 6364</b> Wave extension
	<b>SG 3655</b> Bracket 50 mm		<b>SG 6365</b> Wave hanger
	<b>SG 3660</b> Bracket 65 mm		<b>SG 6366</b> Wave carrier for draw rod
	<b>SG 6004</b> Eyelet		<b>SG 10075</b> Lead weight 50 g/m

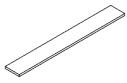

**SG 10076**

Fabric weight

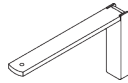

**SG 11203**

Smart Fix 120 mm

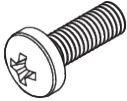

**SG 10277**

Pan head screw M4x12



**SG 11204**

Smart Fix 150 mm

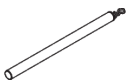

**SG 10430**

Draw rod 50 cm

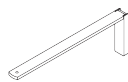

**SG 11205**

Smart Fix 200 mm



**SG 10431**

Draw rod 75 cm

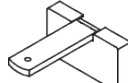

**SG 11210**

Square Smart Fix 60 mm

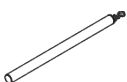

**SG 10432**

Draw rod 100 cm

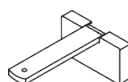

**SG 11211**

Square Smart Fix 80 mm

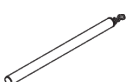

**SG 10433**

Draw rod 125 cm

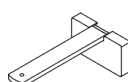

**SG 11212**

Square Smart Fix 100 mm



**SG 10434**

Draw rod 150 cm

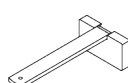

**SG 11213**

Square Smart Fix 120 mm



**SG 10492**

Pan head screw M4x8

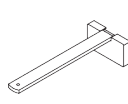

**SG 11214**

Square Smart Fix 150 mm

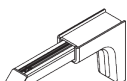

**SG 11154**

Universal Smart Fix 120 mm

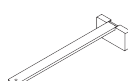

**SG 11215**

Square Smart Fix 200 mm

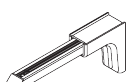

**SG 11155**

Universal Smart Fix 150 mm



**SG 11295**

End stop

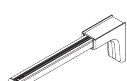

**SG 11156**

Universal Smart Fix 200 mm



**SG 11301**

2C glider on strip

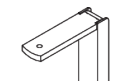

**SG 11200**

Smart Fix 60 mm



**SG 11302**

Wave 2C glider cord 80 mm

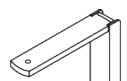

**SG 11201**

Smart Fix 80 mm



**SG 11303**

Wave 2C glider cord 60 mm



**SG 11202**

Smart Fix 100 mm



**SG 11305**

2C glider for direct sewing



# SG 6465

---

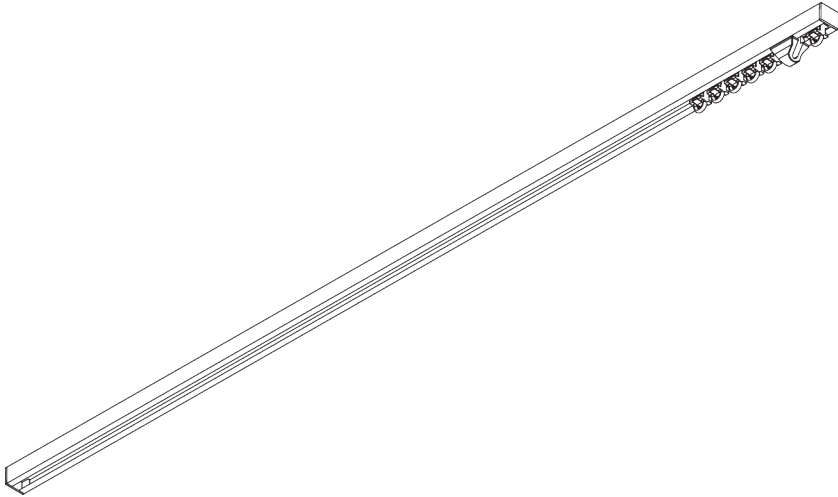

## PRODUCT INFORMATION

- **Operation:** hand
- **Range:** S - M
- **Fitting:** ceiling, recess
- **Colours:** white RAL 9016, black RAL 9005 or anodised aluminum, special colours possible (recess profile only in white RAL 9016, black RAL 9005 or special color)
- **Fabrics:** refer to Silent Gliss fabric collection

### **Features:**

- 2-component (2C) glider technology
- Wave (2C)
- Bendable
- Bendable recess profile

# SYSTEM SPECIFICATIONS

## A. PROFILE

### Profile and bending information

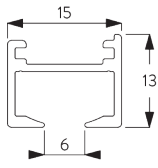

**SG 6466**

Profile

Radius:  
✓ 8 cm, 12 cm, 16 cm,  
>25 cm

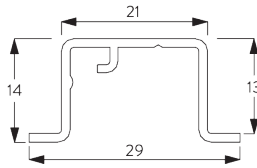

**SG 11231**

Recess profile

Radius:  
✓ >27 cm

## B. HOW TO MEASURE

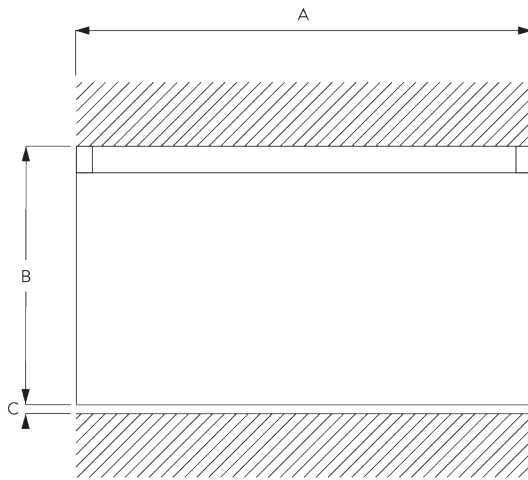

A: System width

B: System height

C: Distance between floor and fabric

## C. SPECIFICATION

### TEXT

#### EN

*Silent Gliss SG 6465 Hand Drawn Curtain Track System. Comprises aluminium profile SG 6466 supplied made to measure in silver anodised or white powder coated, alternatively a specified RAL colour. SG 11130 at 14/m, 2 end covers SG 6471 and 2 SG 6065 stops. Top fixed with brackets. Recess profile SG 11231 is optional. SG 3060 at max. 300 mm centres. Silent Gliss Wave option is available.*

#### SV

*Silent Gliss SG 6465 handdragssystem. Består av aluminiumprofil SG 6466 i specificerad längd i vitlack, alu natur eller angiven RAL färg. 14 st SG 11300 SILENT TRACK glid per meter, 2 st SG 6471 ändskydd samt 2 st SG 6065 vridstopp per system. Kan användas med system Wave. Kan också levereras med profil för infällning SG 11231. Takmonteras med fäste SG 3060 c/c 300 mm.*

#### NO

*Silent Gliss SG 6465 Manuell gardinskinne. Består av aluminiumprofil SG 6466 i spesifisert lengde, standard i hvitlakkert eller alu natur. Kan også leveres i spesifisert RAL farge. 14 stk SG 11300 SILENT TRACK glidere pr meter, 2 stk SG 6471 endeløkk og 2 stk 6065 fjær pr system. Takmonteres med feste SG 3060 c/c 300 mm. Kan leveres med profil for innfelling SG 11231.*

#### DA

*Silent Gliss SG 6465 håndtrukket gardinskinnesystem. Består af en aluminiumprofil SG 6466 i ønsket længde, sølvanodiseret eller hvid pulverlakering, alternativt en specificeret RAL-farve. 14 stk. SG 11130 glidere pr. m og 2 stk. SG 6471 endelåg samt 2 stk. SG 6065 endestop. Loftmonteres med beslag. Kan leveres med indfældningsprofil SG 11231. SG 3060 med højst 300 mm afstand. Kan bruges med Silent Gliss Wave.*

# FITTING

## A. FITTING INFORMATION

For detailed fitting information, visit the [Silent Gliss website](#).

### Fixing points

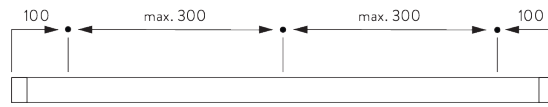

## B. CEILING FITTING

### Clamp SG 3060

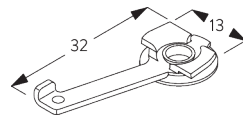
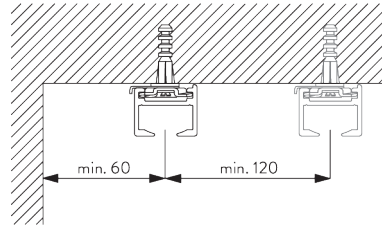

**SG 3060**  
Clamp

## C. RECESS FITTING

### Recess profile SG 11231

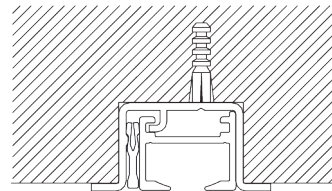

One wedge SG 11237 per fixing point.  
For detailed recess fitting, visit the [Silent Gliss website](#).

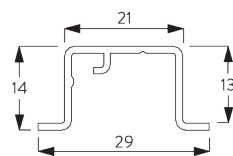

**SG 11231**  
Recess profile

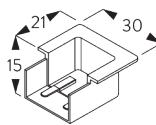

**SG 11239**  
Recess Mask

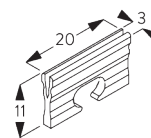

**SG 11237**  
Wedge

# SYSTEM OPTIONS

## A. WAVE

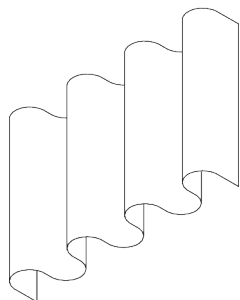

SG 11295

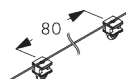

SG 11302



SG 2255



SG 2256

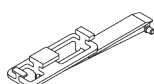

SG 6364



SG 6365

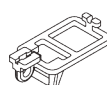

SG 6366

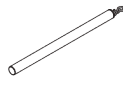

SG 10430-34

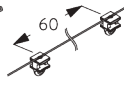

SG 11303

### Standard components:

- SG 11295 End stop
- SG 11302 Wave 2C glider cord 80 mm

### Optional components (min. radius >25 cm):

- SG 2255 Brake
- SG 2256 Brake
- SG 6364 Wave extension
- SG 6365 Wave hanger
- SG 6366 Wave carrier for draw rod
- SG 10430-34 Draw rod
- SG 11303 Wave 2C glider cord 60 mm



SG 3582

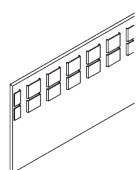

SG 6349

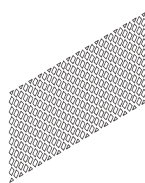

SG 6363

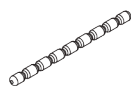

SG 10075



SG 10076

### Curtain components:

- SG 3582 Hook
- SG 6349 Wave curtain tape
- SG 6363 Wave top hemming tape
- SG 10075 Lead weight 50 gr/m
- SG 10076 Fabric weight

Wave stack depth - 2C glider cord (standard components)

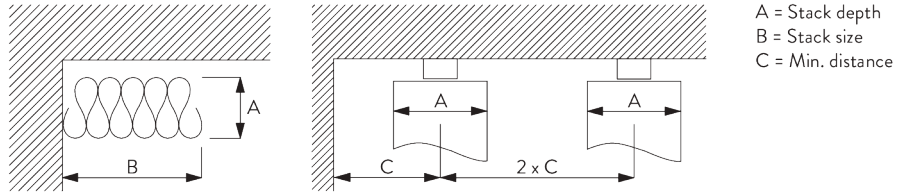



2C Glider cord SG 11302	Pockets between hooks	Approx. curtain fullness	Stack depth A	Stack size B*	Min distance C
80	6	~2.1	140	180 per metre of track	90
80	7	~2.3	160	180 per metre of track	100

2C Glider cord SG 11303	Pockets between hooks	Approx. curtain fullness	Stack depth A	Stack size B*	Min distance C
60	4	~2.1	100	230 per metre of track	70
60	5	~2.3	120	230 per metre of track	80





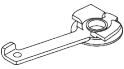

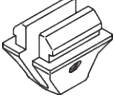
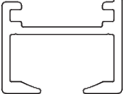
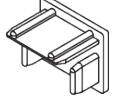
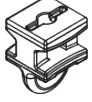

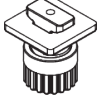
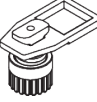

\*Stack size B when using optional extension arm increases  
by 150 mm per curtain stack!



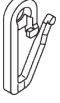

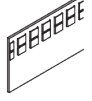

# PARTS

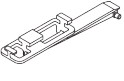
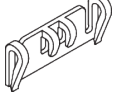
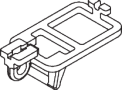
## A. STANDARD PARTS

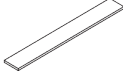
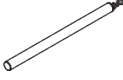
	<b>SG 3060</b> Clamp
	<b>SG 3599</b> Hook
	<b>SG 6065</b> End stop
	<b>SG 6245</b> Spring stop
	<b>SG 6466</b> Profile
	<b>SG 6471</b> End cover
	<b>SG 11300</b> 2C glider

## B. OPTIONAL PARTS

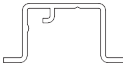
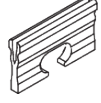
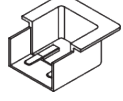
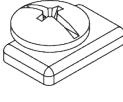
	<b>SG 2255</b> Brake
	<b>SG 2256</b> Brake
	<b>SG 3012</b> Hook
	<b>SG 3062</b> Connection bridge
	<b>SG 3582</b> Hook
	<b>SG 3598</b> Eyelet
	<b>SG 6057</b> Glider
	<b>SG 6064</b> End stop
	<b>SG 6082</b> Glider
	<b>SG 6349</b> Wave curtain tape
	<b>SG 6363</b> Wave top hemming tape
	<b>SG 6364</b> Wave extension
	<b>SG 6365</b> Wave hanger
	<b>SG 6366</b> Wave carrier for draw rod

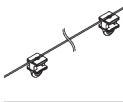
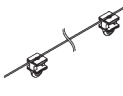
	<b>SG 10075</b> Lead weight 50 g/m
	<b>SG 10076</b> Fabric weight
	<b>SG 10430</b> Draw rod 50 cm
	<b>SG 10431</b> Draw rod 75 cm
	<b>SG 10432</b> Draw rod 100 cm
	<b>SG 10433</b> Draw rod 125 cm
	<b>SG 10434</b> Draw rod 150 cm
	<b>SG 11231</b> Recess profile
	<b>SG 11237</b> Wedge
	<b>SG 11239</b> Recess Mask
	<b>SG 11295</b> End stop
	<b>SG 11301</b> 2C glider on strip
	<b>SG 11302</b> Wave 2C glider cord 80 mm
	<b>SG 11303</b> Wave 2C glider cord 60 mm



---

**SG 11305**

---

*2C glider for direct sewing*

---





# SG 6475

---



## PRODUCT INFORMATION

- **Operation:** hand
- **Range:** S - M
- **Fitting:** ceiling
- **Colours:** white RAL 9016 or anodised aluminum, special colours possible
- **Fabrics:** refer to Silent Gliss fabric collection

### **Features:**

- 2-component (2C) glider technology
- Wave (2C)
- Bendable

# SYSTEM SPECIFICATION

## A. PROFILE

Profile and bending information

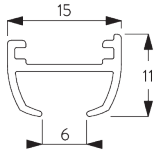

**SG 6475p**

Profile

Radius:  
8 cm, 12 cm, 16 cm,  
>25 cm

## B. HOW TO MEASURE

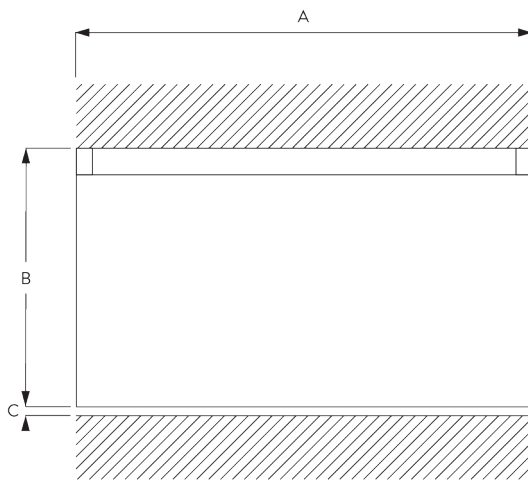

A: System width  
B: System height  
C: Distance between floor and fabric

## C. SPECIFICATION

TEXT

### EN

Silent Gliss SG 6475 Hand Drawn Curtain Track System. Comprises aluminium profile SG 6475 supplied made to measure in silver anodised or white powder coated, alternatively a specified RAL colour. SG 1130 at 14/m, 2 end covers SG 6476 and 2 SG 6065 stops. Top fixed with brackets SG 3060 at max. 300 mm centres. Silent Gliss Wave option is available.

### SV

Silent Gliss SG 6475 handdragssystem. Består av aluminiumprofil SG 6475 i specificerad längd i vitlack, alu natur eller angiven RAL färg. 14 st SG 11300 SILENT TRACK glid per meter, 2 st SG 6476 ändskydd samt 2 st SG 6065 vridstopp per system. Takmonteras med fäste SG 3060 c/c 300 mm. Kan användas med system Wave.

### NO

Silent Gliss SG 6475 Manuell gardinskinne. Består av aluminiumprofil SG 6475 i spesifisert lengde, standard i hvitlakkert eller alu natur. Kan også leveres i spesifisert RAL farge. 14 stk SG 11300 SILENT TRACK glidere pr meter, 2 stk 6476 endeløkk og 2 stk SG 6065 vristopp pr system. Takmonteres med feste SG 3060 c/c 300 mm. Kan kombineres med Wave system.

### DA

Silent Gliss SG 6475 håndtrukket gardinskinnesystem. Består af en aluminiumprofil SG 6475 i ønsket længde, sølvanodiseret eller hvid pulverlakering, alternativt en specificeret RAL-farve. 14 stk. SG 11300 glidere pr. m og 2 stk. SG 6476 endelåg samt 2 stk. SG 6065 endestop. Loftmonteres med beslagene SG 3060 med højst 300 mm afstand. Kan bruges med Silent Gliss Wave.

# FITTING

## A. FITTING INFORMATION

For detailed fitting information, visit the Silent Gliss website.

### Fixing points

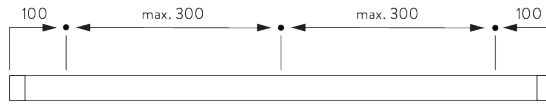

## B. CEILING FITTING

### Clamp SG 3060

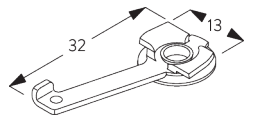
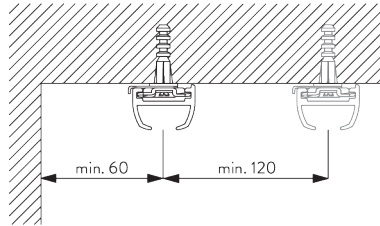

SG 3060  
Clamp

# SYSTEM OPTIONS

## A. WAVE

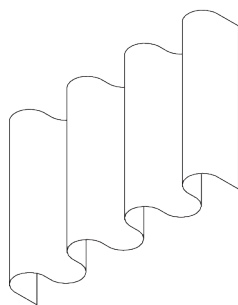

SG 11295

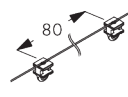

SG 11302

Standard components:

- SG 11295 End stop
- SG 11302 Wave 2C glider cord 80 mm

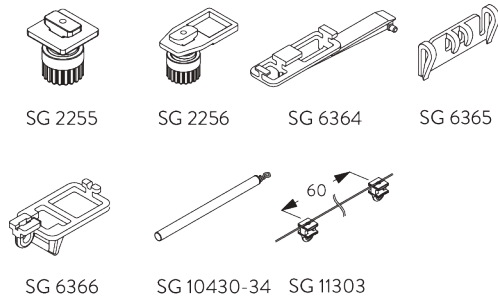

Optional components (min. radius >25 cm):

- SG 2255 Brake
- SG 2256 Brake
- SG 6364 Wave extension
- SG 6365 Wave hanger
- SG 6366 Wave carrier for draw rod
- SG 10430-34 Draw rod
- SG 11303 Wave 2C glider cord 60 mm

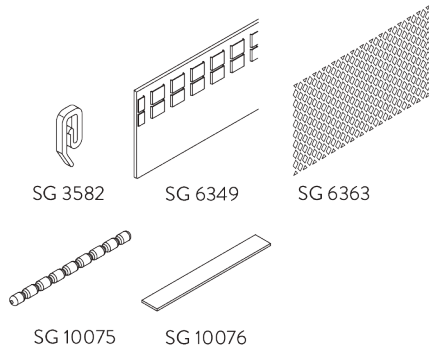

Curtain components:

- SG 3582 Hook
- SG 6349 Wave curtain tape
- SG 6363 Wave top hemming tape
- SG 10075 Lead weight 50 gr/m
- SG 10076 Fabric weight

Wave stack depth - 2C glider cord (standard components)

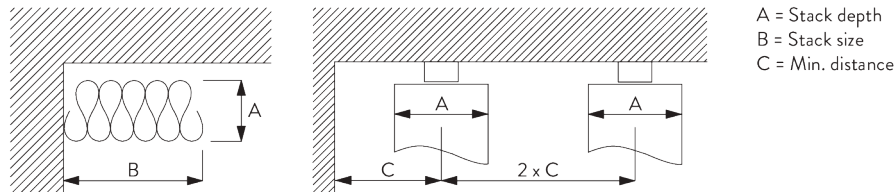

A = Stack depth  
B = Stack size  
C = Min. distance







2C Glider cord SG 11302	Pockets between hooks	Approx. curtain fullness	Stack depth A	Stack size B*	Min distance C
80	6	~2.1	140	180 per metre of track	90
80	7	~2.3	160	180 per metre of track	100

2C Glider cord SG 11303	Pockets between hooks	Approx. curtain fullness	Stack depth A	Stack size B*	Min distance C
60	4	~2.1	100	230 per metre of track	70
60	5	~2.3	120	230 per metre of track	80

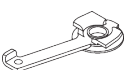

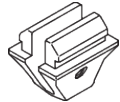

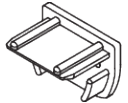



\*Stack size B when using optional extension arm increases by 150 mm per curtain!

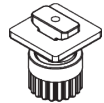
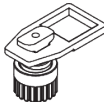

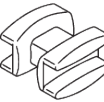

# PARTS

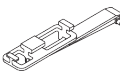
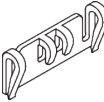
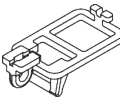
## A. STANDARD PARTS

	<b>SG 3060</b> Clamp
	<b>SG 3599</b> Hook
	<b>SG 6065</b> End stop
	<b>SG 6245</b> Spring stop
	<b>SG 6475p</b> Profile
	<b>SG 6476</b> End cover
	<b>SG 11300</b> 2C glider

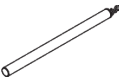
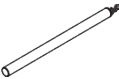
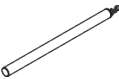
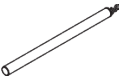
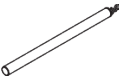
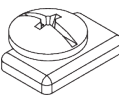
## B. OPTIONAL PARTS

	<b>SG 2255</b> Brake
	<b>SG 2256</b> Brake
	<b>SG 3012</b> Hook
	<b>SG 3062</b> Connection bridge
	<b>SG 3582</b> Hook
	<b>SG 6057</b> Glider
	<b>SG 6082</b> Glider
	<b>SG 6349</b> Wave curtain tape
	<b>SG 6363</b> Wave top hemming tape
	<b>SG 6364</b> Wave extension
	<b>SG 6365</b> Wave hanger
	<b>SG 6366</b> Wave carrier for draw rod
	<b>SG 10075</b> Lead weight 50 g/m
	<b>SG 10076</b> Fabric weight

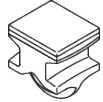
	<b>SG 10430</b> Draw rod 50 cm
	<b>SG 10431</b> Draw rod 75 cm
	<b>SG 10432</b> Draw rod 100 cm
	<b>SG 10433</b> Draw rod 125 cm
	<b>SG 10434</b> Draw rod 150 cm
	<b>SG 11295</b> End stop
	<b>SG 11301</b> 2C glider on strip
	<b>SG 11302</b> Wave 2C glider cord 80 mm
	<b>SG 11303</b> Wave 2C glider cord 60 mm
	<b>SG 11305</b> 2C glider for direct sewing



# SG 6815

---

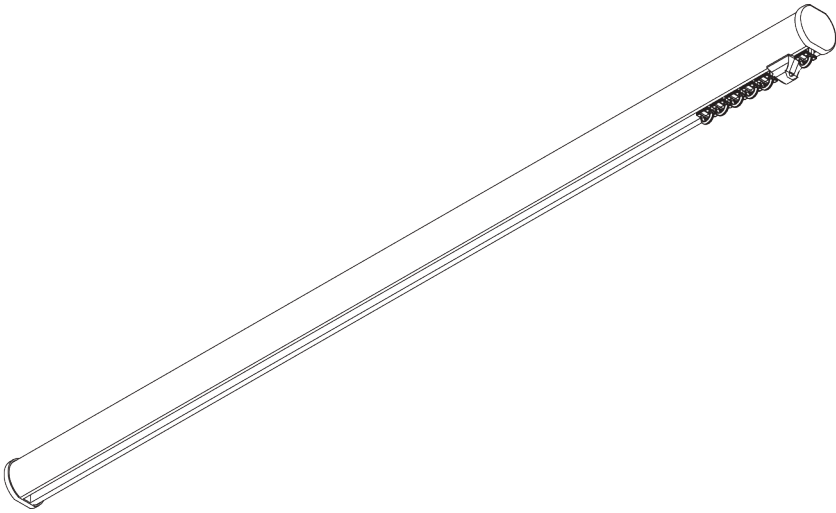

## PRODUCT INFORMATION

- **Operation:** hand
- **Range:** S - M
- **Fitting:** ceiling, wall
- **Colours:** white RAL 9016 or anodised aluminum, special colours possible
- **Fabrics:** refer to Silent Gliss fabric collection

### **Features:**

- 2-component (2C) glider technology
- Wave (2C)
- Bendable

# SYSTEM SPECIFICATIONS

## A. PROFILE

Profile and bending information

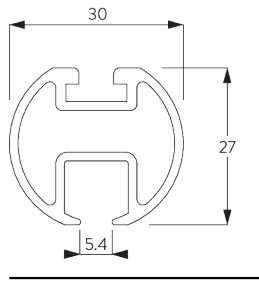

SG 6103p

Profile

Radius: >25 cm

## B. HOW TO MEASURE

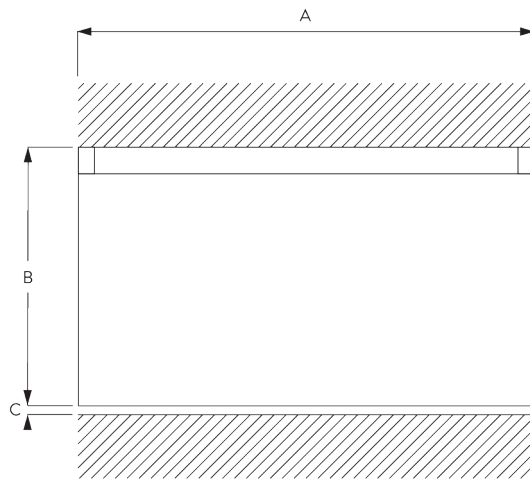

A: System width

B: System height

C: Distance between floor and fabric

## C. SPECIFICATION

### TEXT

#### EN

Silent Gliss SG 6815 Hand Drawn Curtain Track System. Comprises aluminium profile SG 6103 supplied made to measure in silver anodised or white powder coated, alternatively a specified RAL colour. SG 11130 at 14/m, 2 end covers SG 6630 and 2 SG 6065 stops. Top fixed with brackets SG 6124/6175 at max. 800 mm centres / wall fix SG Smart Fix at max. 800 mm centres. Silent Gliss Wave option is available.

#### SV

Silent Gliss SG 6815 handdragssystem. Består av aluminiumprofil SG 6103 i specificerad längd i vitlack, alu natur eller angiven RAL färg. 14 st SG 11300 SILENT TRACK glid per meter, 2 st SG 6630 ändskydd samt 2 st SG 6065 vridstopp per system. Takmonteras med fäste SG 6124/6175 c/c 800 mm. Kan användas med system Wave.

#### NO

Silent Gliss SG 6815 Manuell gardinskinne. Består av aluminiumprofil SG 6103 i spesifisert lengde, standard i hvitlakkert eller alu natur. Kan også leveres i spesifisert RAL farge. 14 stk SG 11300 SILENT TRACK glidere pr meter, 2 stk 6630 endelokk og 2 stk SG 6065 vristopp pr system. Takmonteres med feste SG 6124/ 6175 c/c 800 mm. Kan kombineres med Wave system.

#### DA

Silent Gliss SG 6815 håndtrukket gardinskinnesystem. Består af en aluminiumprofil SG 6103 i ønsket længde, sølvanodiseret eller hvid pulverlakering, alternativt en specificeret RAL-farve. 14 stk. SG 11130 glidere pr. m og 2 stk. SG 6630 endelåg samt 2 stk. SG 6065 endestop. Loftmonteres med beslagene SG 6124/6175 medhøjest 800 mm afstand. Vægmonteres med SG Smart Fix med højest 800 mm afstand. Kan bruges med Silent Gliss Wave.



# FITTING

## A. FITTING INFORMATION

For detailed fitting information, visit the Silent Gliss website.

### Fixing points

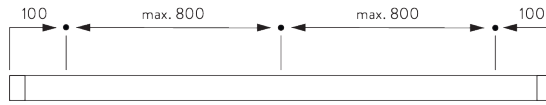

## B. CEILING FITTING

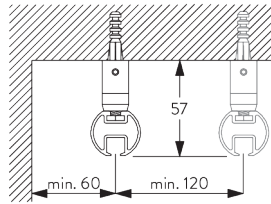

Mini hanger SG 6175

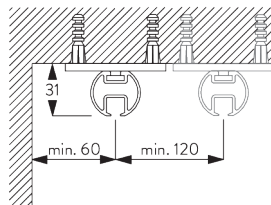

Bracket SG 6124

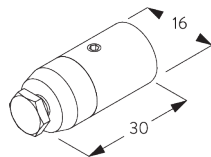

SG 6175  
Mini hanger

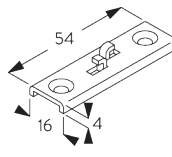

SG 6124  
Bracket

## C. WALL FITTING

### Smart Fix

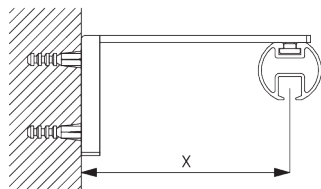

**Smart Fix with slot SG 11206 - SG 11208:**  
Screw SG 10492 (M4x8) needed.

Smart Fix	X mm
SG 11206 / SG 11216	33-51
SG 11207 / SG 11217	53-71
SG 11208 / SG 11218	73-91
SG 11154	102-130
SG 11155	132-160
SG 11156	182-210

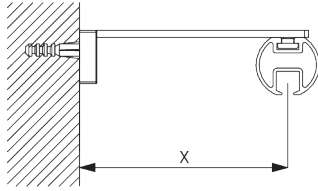

**Square Smart Fix with slot SG 11216 - SG 11218:**

Screw SG 10492 (M4x8) needed.

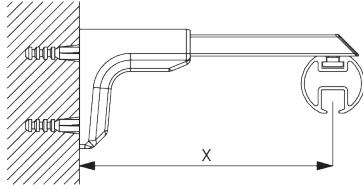

**Universal Smart Fix SG 11154 - SG 11156:**

Screw SG 11131 (M4x6) needed.

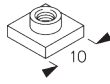

**SG 6117**

Slot nut



**SG 10492**

Pan head screw M4x8



**SG 11131**

Pan head screw with flange M4x6

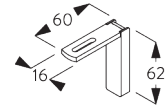

**SG 11206**

Smart Fix with slot 60 mm

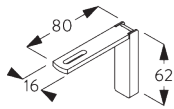

**SG 11207**

Smart Fix with slot 80 mm

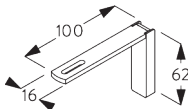

**SG 11208**

Smart Fix with slot 100 mm

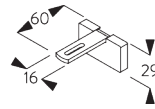

**SG 11216**

Square Smart Fix with slot 60 mm

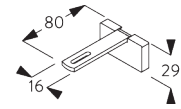

**SG 11217**

Square Smart Fix with slot 80 mm

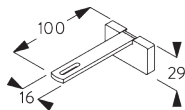

**SG 11218**

Square Smart Fix with slot 100 mm

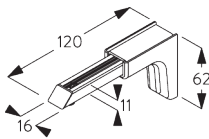

**SG 11154**

Universal Smart Fix 120 mm

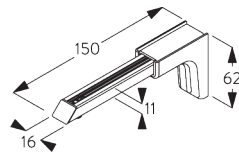

**SG 11155**

Universal Smart Fix 150 mm

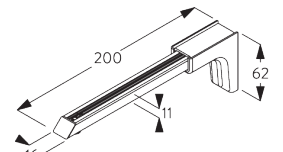

**SG 11156**

Universal Smart Fix 200 mm

# SYSTEM OPTIONS

## A. WAVE

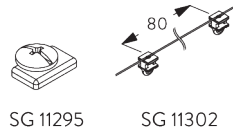
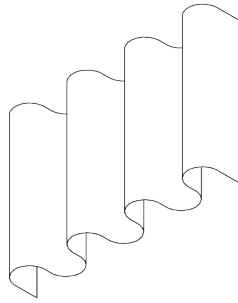

SG 11295

SG 11302

### Standard components:

- SG 11295 End stop
- SG 11302 Wave 2C glider cord 80 mm

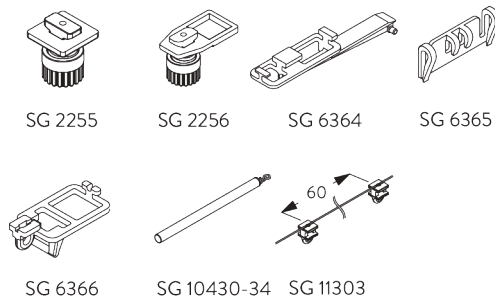

SG 2255

SG 2256

SG 6364

SG 6365

SG 6366

SG 10430-34

SG 11303

### Optional components:

- SG 2255 Brake
- SG 2256 Brake
- SG 6364 Wave extension
- SG 6365 Wave hanger
- SG 6366 Wave carrier for draw rod
- SG 10430-34 Draw rod
- SG 11303 Wave 2C glider cord 60 mm

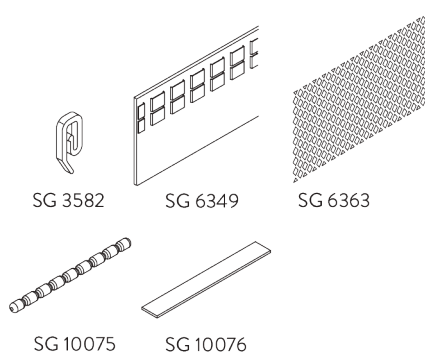

SG 3582

SG 6349

SG 6363

SG 10075

SG 10076

### Curtain components:

- SG 3582 Hook
- SG 6349 Wave curtain tape
- SG 6363 Wave top hemming tape
- SG 10075 Lead weight 50 gr/m
- SG 10076 Fabric weight

Wave stack depth - 2C glider cord (standard components)

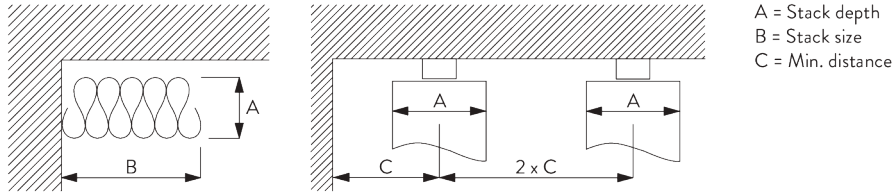







2C Glider cord SG 11302	Pockets between hooks	Approx. curtain fullness	Stack depth A	Stack size B*	Min distance C
80	6	~2.1	140	180 per metre of track	90
80	7	~2.3	160	180 per metre of track	100

2C Glider cord SG 11303	Pockets between hooks	Approx. curtain fullness	Stack depth A	Stack size B*	Min distance C
60	4	~2.1	100	230 per metre of track	70
60	5	~2.3	120	230 per metre of track	80



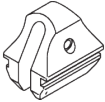

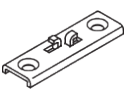
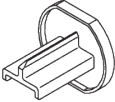



\*Stack size B when using optional extension arm increases by 150 mm per curtain!

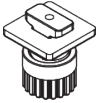
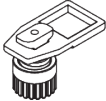

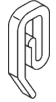
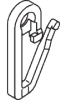

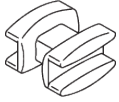

# PARTS

## A. STANDARD PARTS

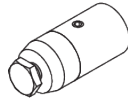
	<b>SG 3599</b> Hook
	<b>SG 6065</b> End stop
	<b>SG 6086</b> Spring stop
	<b>SG 6103p</b> Profile
	<b>SG 6124</b> Bracket
	<b>SG 6630</b> End cover
	<b>SG 11300</b> 2C glider

## B. OPTIONAL PARTS

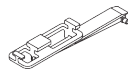
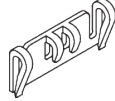
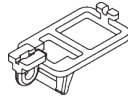
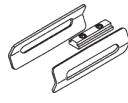
	<b>SG 2255</b> Brake
	<b>SG 2256</b> Brake
	<b>SG 3012</b> Hook
	<b>SG 3581</b> Hook
	<b>SG 3582</b> Hook
	<b>SG 3598</b> Eyelet
	<b>SG 6004</b> Eyelet
	<b>SG 6053</b> Spring stop
	<b>SG 6057</b> Glider
	<b>SG 6075</b> End stop with hook
	<b>SG 6082</b> Glider
	<b>SG 6094</b> Roller
	<b>SG 6098</b> Roller
	<b>SG 6117</b> Slot nut

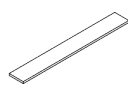
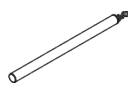
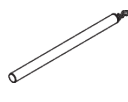
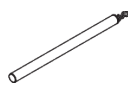
	<b>SG 6175</b> Mini hanger
	<b>SG 6240</b> Roller
	<b>SG 6283</b> Roller
	<b>SG 6349</b> Wave curtain tape
	<b>SG 6363</b> Wave top hemming tape
	<b>SG 6364</b> Wave extension
	<b>SG 6365</b> Wave hanger
	<b>SG 6366</b> Wave carrier for draw rod
	<b>SG 6635</b> Connection bridge set
	<b>SG 10075</b> Lead weight 50 g/m
	<b>SG 10076</b> Fabric weight
	<b>SG 10430</b> Draw rod 50 cm
	<b>SG 10431</b> Draw rod 75 cm
	<b>SG 10432</b> Draw rod 100 cm

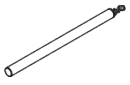

**SG 10433**

Draw rod 125 cm

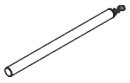

**SG 10434**

Draw rod 150 cm

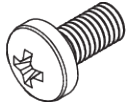

**SG 10492**

Pan head screw M4x8



**SG 11131**

Pan head screw with flange M4x6

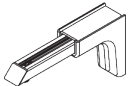

**SG 11154**

Universal Smart Fix 120 mm

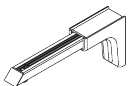

**SG 11155**

Universal Smart Fix 150 mm

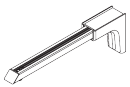

**SG 11156**

Universal Smart Fix 200 mm

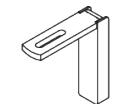

**SG 11206**

Smart Fix with slot 60 mm

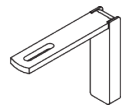

**SG 11207**

Smart Fix with slot 80 mm

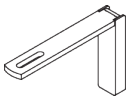

**SG 11208**

Smart Fix with slot 100 mm

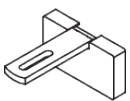

**SG 11216**

Square Smart Fix with slot 60 mm

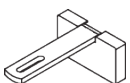

**SG 11217**

Square Smart Fix with slot 80 mm

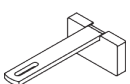

**SG 11218**

Square Smart Fix with slot 100 mm

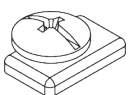

**SG 11295**

End stop



**SG 11301**

2C glider on strip

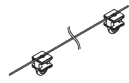

**SG 11302**

Wave 2C glider cord 80 mm

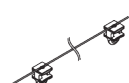

**SG 11303**

Wave 2C glider cord 60 mm

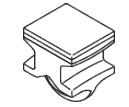

**SG 11305**

2C glider for direct sewing

# SG 6820

---

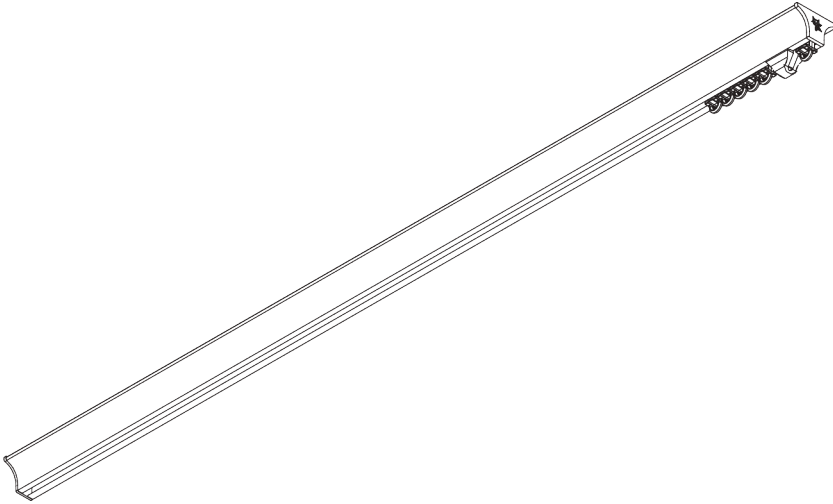

## PRODUCT INFORMATION

- **Operation:** hand
- **Range:** S - M
- **Fitting:** ceiling
- **Colours:** white RAL 9016 or anodised aluminum, special colours possible
- **Fabrics:** refer to Silent Gliss fabric collection

### **Features:**

- 2-component (2C) glider technology
- Wave (2C)
- Funnel shaped design
- Bendable

# SYSTEM SPECIFICATIONS

## A. SYSTEM DIMENSIONS

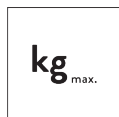

10 kg

## B. PROFILE

Profile and bending information

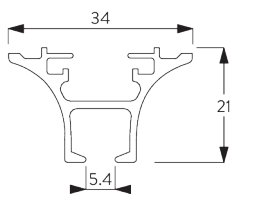

**SG 6821**

Profile Funnel

 Radius: >27 cm

## C. HOW TO MEASURE

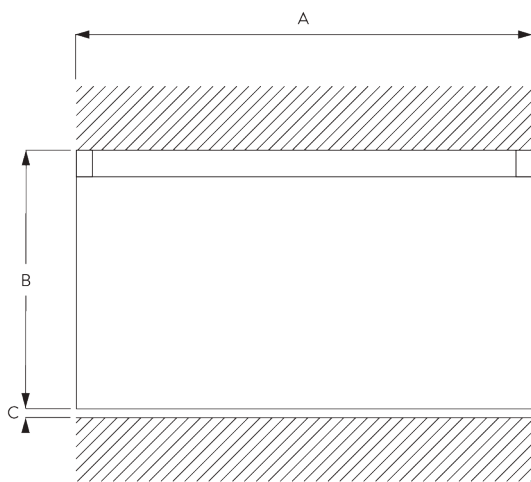

A: System width

B: System height

C: Distance between floor and fabric



## **D. SPECIFICATION**

### **TEXT**

#### **EN**

Silent Gliss SG 6820 Hand Drawn Curtain Track System. Comprises aluminium profile SG 6821 supplied made to measure in silver anodised or white powder coated, alternatively a specified RAL colour. SG 1130 at 14/m, 2 end covers SG 6823 and 2 SG 6065 stops. Top fixed with brackets SG 11236 max. 500 mm centres. Silent Gliss Wave option is available.

#### **SV**

Silent Gliss SG 6820 handdragssystem. Består av aluminiumprofil SG 6821 i specificerad längd i vitlack, alu natur eller angiven RAL färg. 14 st SG 11300 SILENT TRACK glid per meter, 2 st SG 6823 ändskydd samt 2 st SG 6065 vridstopp per system. Takmonteras med fäste SG 11236 c/c 500 mm. Kan användas med system Wave.

#### **NO**

Silent Gliss SG 6820 Manuell gardinskinne. Består av aluminiumprofil SG 6821 i spesifisert lengde, standard i hvitlakkert eller alu natur. Kan også leveres i spesifisert RAL farge. 14 stk SG 11300 SILENT TRACK glidere pr meter, 2 stk 6823 endeløkk og 2 stk SG 6065 vristopp pr system. Takmonteres med feste SG 11236 c/c 500mm. Kan kombineres med Wave system.

#### **DA**

Silent Gliss SG 6820 håndtrukket gardinskinnesystem. Består af en aluminiumprofil SG 6821 i ønsket længde, sølvanodiseret eller hvid pulverlakering, alternativt en specificeret RAL-farve. 14 stk. SG 1130 glidere pr. m og 2 stk. SG 6823 endelåg samt 2 stk. SG 6065 endestop. Loftmonteres med beslagene SG 11236 med højst 500 mm afstand. Kan bruges med Silent Gliss Wave.

# FITTING

## **A. FITTING INFORMATION**

For detailed fitting information, visit the Silent Gliss website.

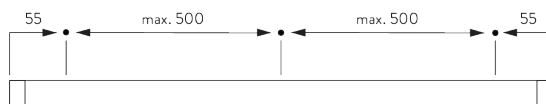

### **Fitting Tool**

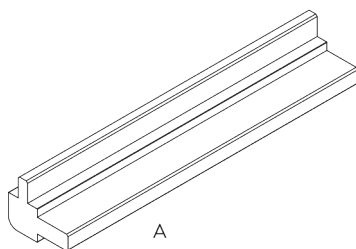

A: Funnel fitting tool SG 6827

For fitting / removing of the funnel profile.

## **B. CEILING FITTING**

### **Clip SG 11236**

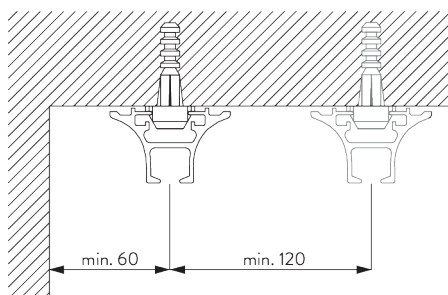

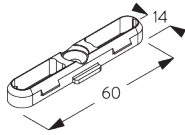

SG 11236

Clip

# SYSTEM OPTIONS

## A. WAVE

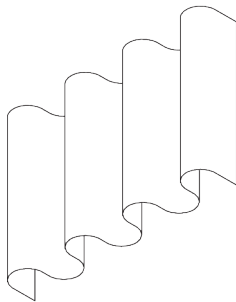

SG 11295

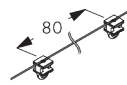

SG 11302

Standard components:

- SG 11295 End stop
- SG 11302 Wave 2C glider cord 80 mm



SG 2255



SG 2256

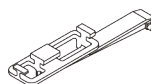

SG 6364



SG 6365

Optional components:

- SG 2255 Brake
- SG 2256 Brake
- SG 6364 Wave extension
- SG 6365 Wave hanger
- SG 6366 Wave carrier for draw rod
- SG 10430-34 Draw rod
- SG 11303 Wave 2C glider cord 60 mm

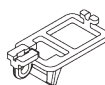

SG 6366



SG 10430-34

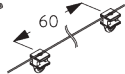

SG 11303



SG 3582

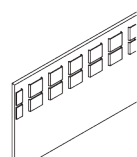

SG 6349

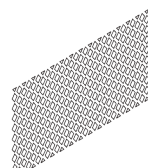

SG 6363

Curtain components:

- SG 3582 Hook
- SG 6349 Wave curtain tape
- SG 6363 Wave top hemming tape
- SG 10075 Lead weight 50 gr/m
- SG 10076 Fabric weight



SG 10075



SG 10076

Wave stack depth - 2C glider cord (standard components)

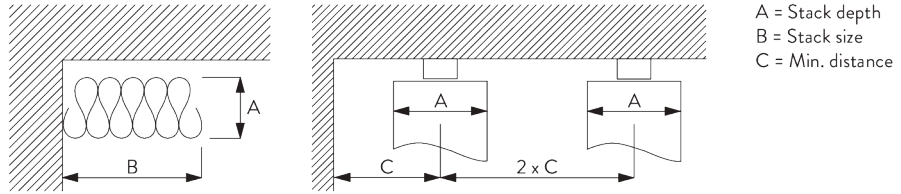







2C Glider cord SG 11302	Pockets between hooks	Approx. curtain fullness	Stack depth A	Stack size B*	Min distance C
80	6	~2.1	140	180 per metre of track	90
80	7	~2.3	160	180 per metre of track	100

2C Glider cord SG 11303	Pockets between hooks	Approx. curtain fullness	Stack depth A	Stack size B*	Min distance C
60	4	~2.1	100	230 per metre of track	70
60	5	~2.3	120	230 per metre of track	80



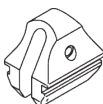

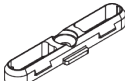





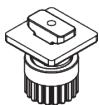
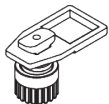

\*Stack size B when using optional extension arm increases  
by 150 mm per curtain stack!





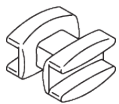

# PARTS

## A. STANDARD PARTS

	<b>SG 3599</b> Hook
	<b>SG 6065</b> End stop
	<b>SG 6086</b> Spring stop
	<b>SG 6821</b> Profile Funnel
	<b>SG 6823</b> End cover
	<b>SG 11236</b> Clip
	<b>SG 11300</b> 2C glider

## B. OPTIONAL PARTS

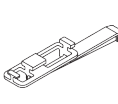
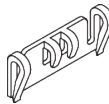
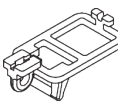
	<b>SG 2255</b> Brake
	<b>SG 2256</b> Brake
	<b>SG 3012</b> Hook
	<b>SG 3582</b> Hook
	<b>SG 3598</b> Eyelet
	<b>SG 3802</b> Connection bridge
	<b>SG 6004</b> Eyelet
	<b>SG 6005</b> Hook
	<b>SG 6053</b> Spring stop
	<b>SG 6057</b> Glider
	<b>SG 6082</b> Glider
	<b>SG 6094</b> Roller
	<b>SG 6098</b> Roller
	<b>SG 6146</b> Hook

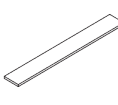
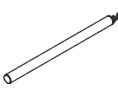
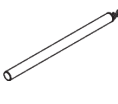
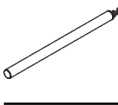
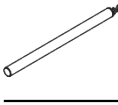
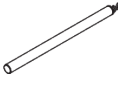
	<b>SG 6240</b> Roller
	<b>SG 6283</b> Roller
	<b>SG 6349</b> Wave curtain tape
	<b>SG 6363</b> Wave top hemming tape
	<b>SG 6364</b> Wave extension
	<b>SG 6365</b> Wave hanger
	<b>SG 6366</b> Wave carrier for draw rod
	<b>SG 10075</b> Lead weight 50 g/m
	<b>SG 10076</b> Fabric weight
	<b>SG 10430</b> Draw rod 50 cm
	<b>SG 10431</b> Draw rod 75 cm
	<b>SG 10432</b> Draw rod 100 cm
	<b>SG 10433</b> Draw rod 125 cm
	<b>SG 10434</b> Draw rod 150 cm

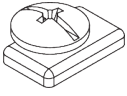

**SG 11295**

*End stop*

---



**SG 11301**

*2C glider on strip*

---



**SG 11302**

*Wave 2C glider cord 80 mm*

---



**SG 11303**

*Wave 2C glider cord 60 mm*

---

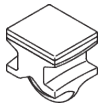

**SG 11305**

*2C glider for direct sewing*

---



# SG 6840

---

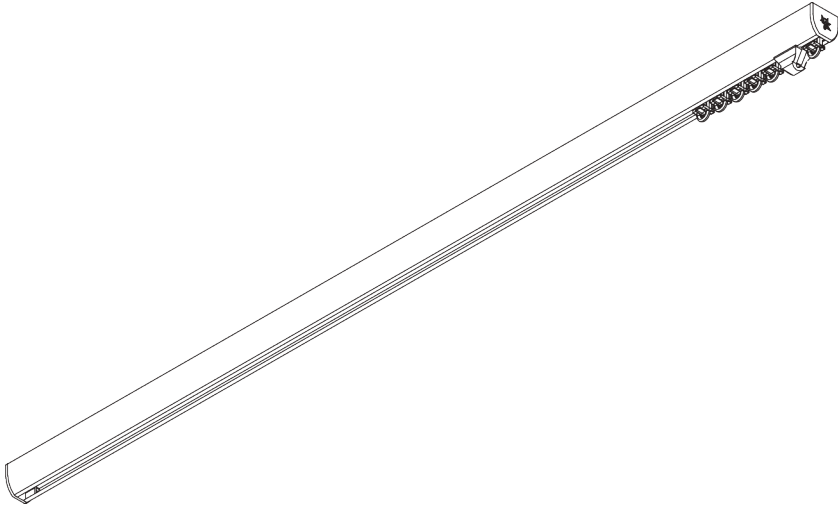

## PRODUCT INFORMATION

- **Operation:** hand
- **Range:** M - L
- **Fitting:** ceiling, wall
- **Colours:** white RAL 9016, black RAL 9005 or anodised aluminum, special colours possible
- **Fabrics:** refer to Silent Gliss fabric collection

### **Features:**

- 2-component (2C) glider technology
- Wave (2C)
- Bendable

# SYSTEM SPECIFICATIONS

## A. PROFILE

Profile and bending information

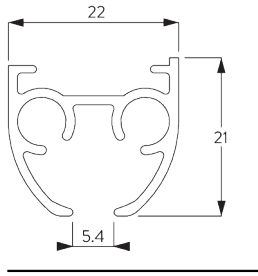

**SG 3841**

Profile

Radius:  
20 cm, >30 cm

## B. HOW TO MEASURE

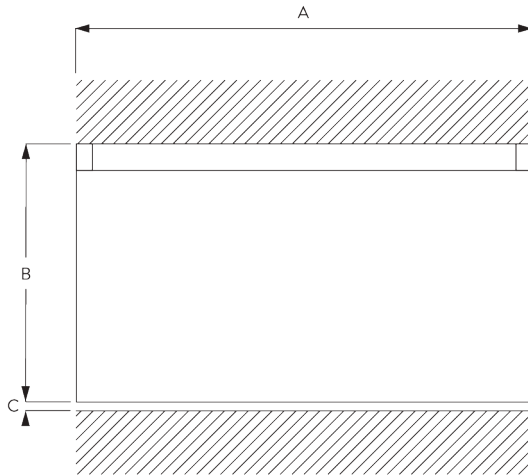

A: System width

B: System height

C: Distance between floor and fabric

## C. SPECIFICATION TEXT

### EN

Silent Gliss SG 6840 Hand Drawn Curtain Track System. Comprises aluminium profile SG 3841 supplied made to measure in silver anodised or white powder coated, alternatively a specified RAL colour. SG 11130 at 14/m, 2 end covers SG 3842 and 2 SG 6065 stops. Top fixed with brackets SG 3825/3826/3832 max. 500 mm centres. Wall fix SG Smart Fix at max. 500mm centres. Silent Gliss Wave option is available.

### SV

Silent Gliss SG 6840 handdragssystem. Består av aluminiumprofil SG 3841 i specificerad längd i vitlack, alu natur eller angiven RAL färg. 14 st SG 11300 SILENT TRACK glid per meter, 2 st SG 3842 ändskydd samt 2 st SG 6065 vridstopp per system. Takmonteras med fäste SG 3825/3826/3832 c/c 500 mm. Vägghmontering med SG Smart Fix c/c 500 mm. Kan användas med system Wave.

### NO

Silent Gliss SG 6820 Manuell gardinskinne. Består av aluminiumprofil SG 3841 i spesifisert lengde, standard i hvitlakkert eller alu natur. Kan også leveres i spesifisert RAL farge. 14 stk SG 11300 SILENT TRACK glidere pr meter, 2 stk 3842 endeløkk og 2 stk SG 6065 vristopp pr system. Takmonteres med feste SG 3825/3826/3832 c/c 500 mm. Veggmontering med SG Smart Fix c/c 500 mm. Kan kombineres med Wave system.

### DA

Silent Gliss SG 6840 håndtrukket gardinskinnesystem. Består af en aluminiumprofil SG 3841 i ønsket længde, sølvanodiseret eller hvid pulverlakering, alternativt en specificeret RAL-farve. 14 stk. SG 11130 glidere pr. m og 2 stk. SG 3842 endelåg samt 2 stk. SG 6065 endestop. Loftmonteres med beslagene SG 3825/3826/3832 med højst 500 mm afstand. Vægmonteres med SG Smart Fix med en afstand på højst 500 mm. Kan bruges med Silent Gliss Wave.



# FITTING

## A. FITTING INFORMATION

For detailed fitting information, visit the Silent Gliss website.

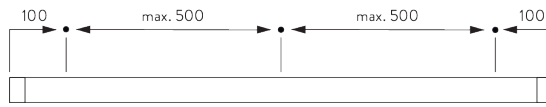

## B. CEILING FITTING

### Clamp SG 3825

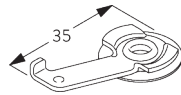
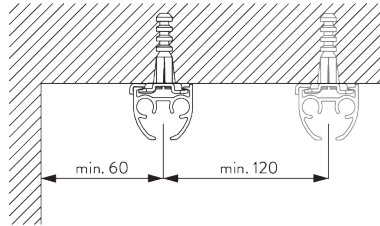

**SG 3825**  
Clamp

### Bracket SG 3826

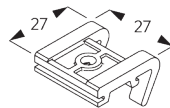
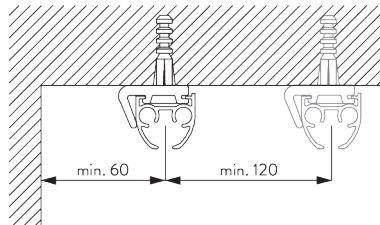

**SG 3826**  
Bracket

### Bracket SG 3832

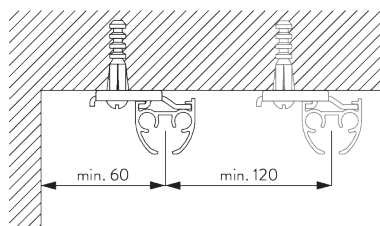

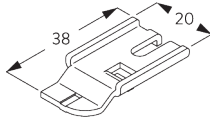

**SG 3832**

Bracket

## C. WALL FITTING

### Smart Fix

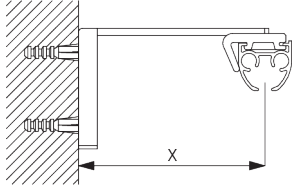

**Smart Fix SG 11200 - SG 11205 and bracket SG 3826:**

Screw SG 10492 (M4x8) needed.

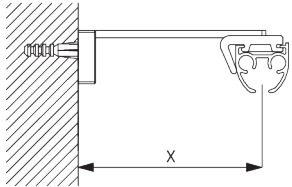

**Square Smart Fix SG 11210 - SG 11215 and bracket SG 3826:**

Screw SG 10492 (M4x8) needed.

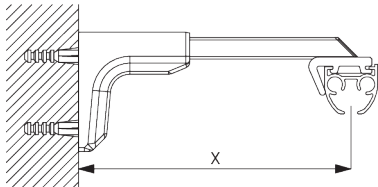

**Universal Smart Fix SG 11154 - SG 11156 and bracket SG 3826:**

Screw SG 10277 (M4x12) needed.

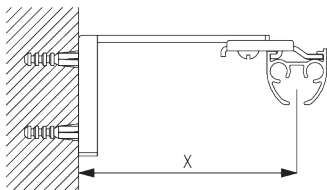

**Smart Fix SG 11200 - SG 11205 and bracket SG 3832:**

Screw SG 10492 (M4x8) needed.

Smart Fix	X mm (SG 3826 / SG 3825)	X mm (SG 3832)
SG 11200 / SG 11210	52	70
SG 11201 / SG 11211	72	90
SG 11202 / SG 11212	92	110
SG 11203 / SG 11213	112	130
SG 11204 / SG 11214	142	160
SG 11205 / SG 11215	192	210
SG 11154	102-130	120-148
SG 11155	132-160	150-178
SG 11156	182-210	200-228

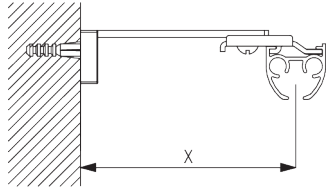

**Square Smart Fix SG 11210 - SG 11215 and bracket SG 3832:**

Screw SG 10492 (M4x8) needed.

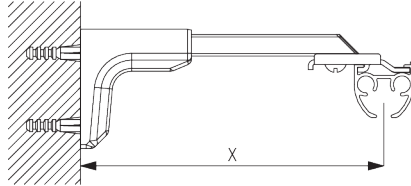

**Universal Smart Fix SG 11154 - SG 11156 and bracket SG 3832:**

Screw SG 10407 (M4x10) needed.

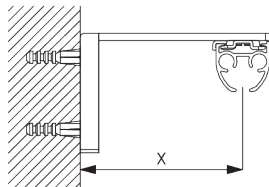

**Smart Fix SG 11200 - SG 11205 and clamp SG 3825:**

Screw SG 10074 (M4x8) needed.

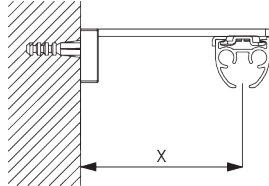

**Square Smart Fix SG 11210 - SG 11215 and clamp SG 3825:**

Screw SG 10074 (M4x8) needed.

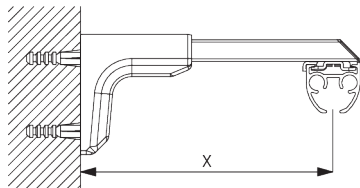

**Universal Smart Fix SG 11154 - SG 11156 and bracket SG 3825:**

Screw SG 11158 (M4x12) needed.

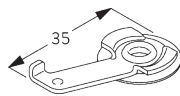

**SG 3825**  
Clamp

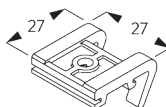

**SG 3826**  
Bracket

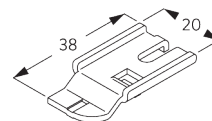

**SG 3832**  
Bracket



**SG 10074**  
Countersunk head screw  
M4x8



**SG 10277**  
Pan head screw M4x12



**SG 10407**  
Pan head screw M4x10



**SG 10492**  
Pan head screw M4x8



**SG 11158**  
Countersunk head screw  
M4x12

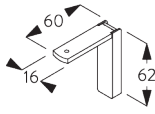

**SG 11200**  
Smart Fix 60 mm

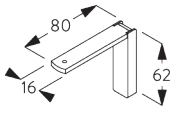

**SG 11201**  
Smart Fix 80 mm

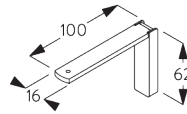

**SG 11202**  
Smart Fix 100 mm

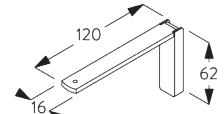

**SG 11203**  
Smart Fix 120 mm

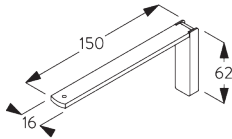

**SG 11204**  
Smart Fix 150 mm

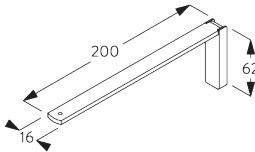

**SG 11205**  
Smart Fix 200 mm

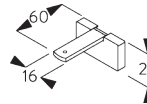

**SG 11210**  
Square Smart Fix 60 mm

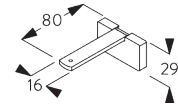

**SG 11211**  
Square Smart Fix 80 mm

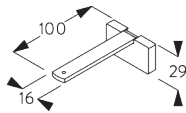

**SG 11212**  
Square Smart Fix 100 mm

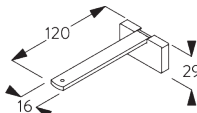

**SG 11213**  
Square Smart Fix 120 mm

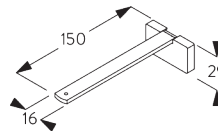

**SG 11214**  
Square Smart Fix 150 mm

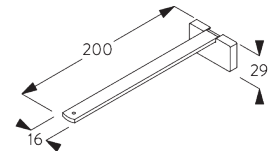

**SG 11215**  
Square Smart Fix 200 mm

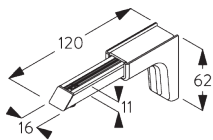

**SG 11154**  
Universal Smart Fix 120 mm

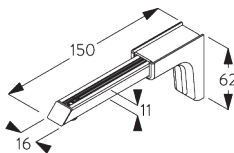

**SG 11155**  
Universal Smart Fix 150 mm

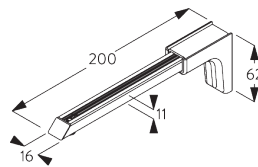

**SG 11156**  
Universal Smart Fix 200 mm

**Bracket SG 3836**

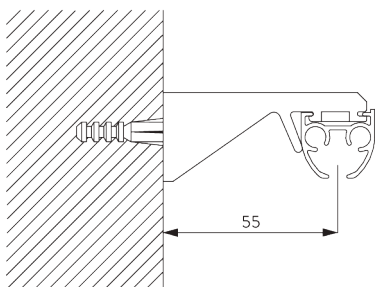

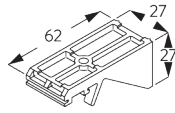

**SG 3836**  
Bracket

# SYSTEM OPTIONS

## A. WAVE

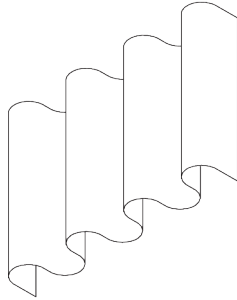

SG 11295

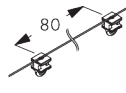

SG 11302

### Standard components:

- SG 11295 End stop
- SG 11302 Wave 2C glider cord 80 mm



SG 2255



SG 2256

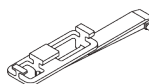

SG 6364



SG 6365

### Optional components (min. radius: >30 cm):

- SG 2255 Brake
- SG 2256 Brake
- SG 6364 Wave extension
- SG 6365 Wave hanger
- SG 6366 Wave carrier for draw rod
- SG 10430-34 Draw rod
- SG 11303 Wave 2C glider cord 60 mm

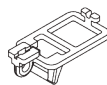

SG 6366

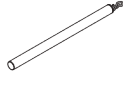

SG 10430-34

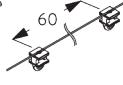

SG 11303



SG 3582

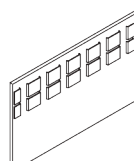

SG 6349

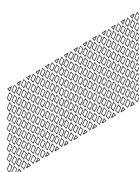

SG 6363

### Curtain components:

- SG 3582 Hook
- SG 6349 Wave curtain tape
- SG 6363 Wave top hemming tape
- SG 10075 Lead weight 50 gr/m
- SG 10076 Fabric weight



SG 10075



SG 10076

Wave stack depth - 2C glider cord (standard components)

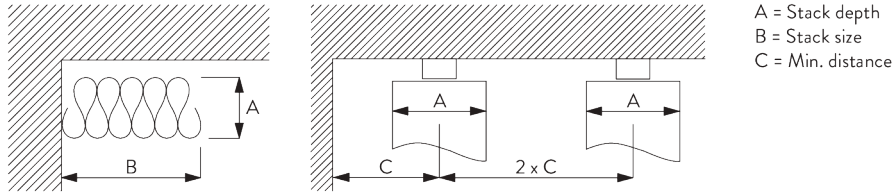







2C Glider cord SG 11302	Pockets between hooks	Approx. curtain fullness	Stack depth A	Stack size B*	Min distance C
80	6	~2.1	140	180 per metre of track	90
80	7	~2.3	160	180 per metre of track	100

2C Glider cord SG 11303	Pockets between hooks	Approx. curtain fullness	Stack depth A	Stack size B*	Min distance C
60	4	~2.1	100	230 per metre of track	70
60	5	~2.3	120	230 per metre of track	80





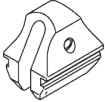





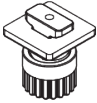

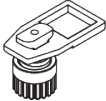
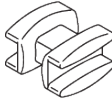



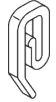
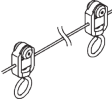
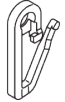

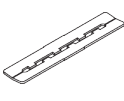

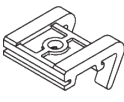
\*Stack size B when using optional extension arm increases  
by 150 mm per curtain stack!

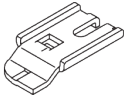
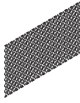
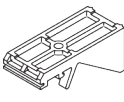
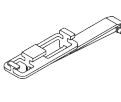
# PARTS

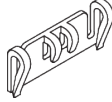
## A. STANDARD PARTS

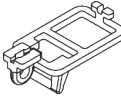
	<b>SG 3599</b> Hook
	<b>SG 3825</b> Clamp
	<b>SG 3841</b> Profile
	<b>SG 3842</b> End cover
	<b>SG 6065</b> End stop
	<b>SG 6086</b> Spring stop
	<b>SG 11300</b> 2C glider

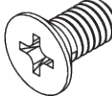
## B. OPTIONAL PARTS

	<b>SG 2255</b> Brake		<b>SG 6064</b> End stop
	<b>SG 2256</b> Brake		<b>SG 6082</b> Glider
	<b>SG 3012</b> Hook		<b>SG 6094</b> Roller
	<b>SG 3581</b> Hook		<b>SG 6098</b> Roller
	<b>SG 3582</b> Hook		<b>SG 6099</b> Wave roller cord 80 mm
	<b>SG 3598</b> Eyelet		<b>SG 6240</b> Roller
	<b>SG 3802</b> Connection bridge		<b>SG 6283</b> Roller
	<b>SG 3826</b> Bracket		<b>SG 6349</b> Wave curtain tape
	<b>SG 3832</b> Bracket		<b>SG 6363</b> Wave top hemming tape
	<b>SG 3836</b> Bracket		<b>SG 6364</b> Wave extension
	<b>SG 6004</b> Eyelet		<b>SG 6365</b> Wave hanger
	<b>SG 6005</b> Hook		<b>SG 6366</b> Wave carrier for draw rod
	<b>SG 6053</b> Spring stop		<b>SG 10074</b> Countersunk head screw M4x8
	<b>SG 6057</b> Glider		<b>SG 10075</b> Lead weight 50 g/m

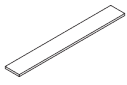

**SG 10076**

Fabric weight

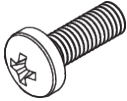

**SG 10277**

Pan head screw M4x12

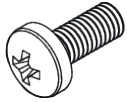

**SG 10407**

Pan head screw M4x10

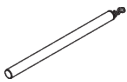

**SG 10430**

Draw rod 50 cm

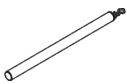

**SG 10431**

Draw rod 75 cm

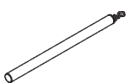

**SG 10432**

Draw rod 100 cm

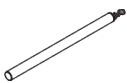

**SG 10433**

Draw rod 125 cm



**SG 10434**

Draw rod 150 cm



**SG 10492**

Pan head screw M4x8

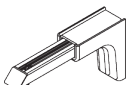

**SG 11154**

Universal Smart Fix 120 mm

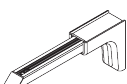

**SG 11155**

Universal Smart Fix 150 mm

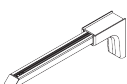

**SG 11156**

Universal Smart Fix 200 mm

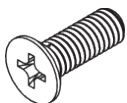

**SG 11158**

Countersunk head screw M4x12

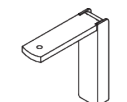

**SG 11200**

Smart Fix 60 mm

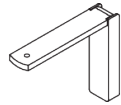

**SG 11201**

Smart Fix 80 mm

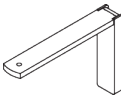

**SG 11202**

Smart Fix 100 mm

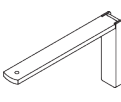

**SG 11203**

Smart Fix 120 mm

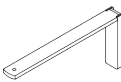

**SG 11204**

Smart Fix 150 mm



**SG 11205**

Smart Fix 200 mm

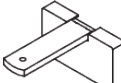

**SG 11210**

Square Smart Fix 60 mm

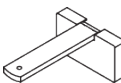

**SG 11211**

Square Smart Fix 80 mm

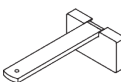

**SG 11212**

Square Smart Fix 100 mm

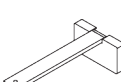

**SG 11213**

Square Smart Fix 120 mm

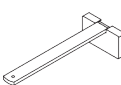

**SG 11214**

Square Smart Fix 150 mm

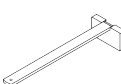

**SG 11215**

Square Smart Fix 200 mm



**SG 11295**

End stop



**SG 11301**

2C glider on strip

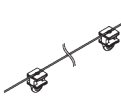

**SG 11302**

Wave 2C glider cord 80 mm

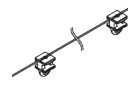

**SG 11303**

Wave 2C glider cord 60 mm

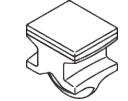

**SG 11305**

2C glider for direct sewing



# SG 6870

---

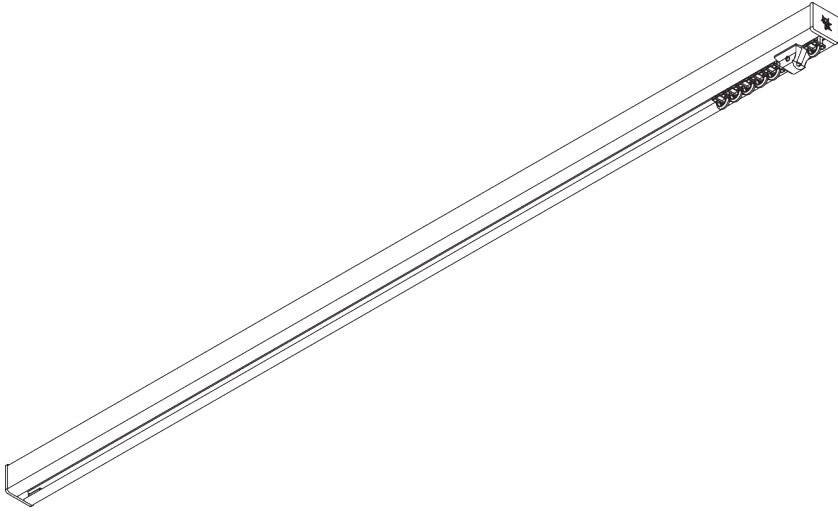

## PRODUCT INFORMATION

- **Operation:** hand
- **Range:** M - L
- **Fitting:** ceiling, wall, recess
- **Colours:** white RAL 9016, black RAL 9005 or anodised aluminum, special colours possible (recess profile only in white RAL 9016, black RAL 9005 or special color)
- **Fabrics:** refer to Silent Gliss fabric collection

### **Features:**

- 2-component (2C) glider technology
- Wave (2C)
- Bendable
- Bendable recess profile

# SYSTEM SPECIFICATIONS

## A. PROFILE

### Profile and bending information

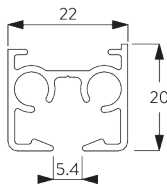

**SG 11190**

Profile

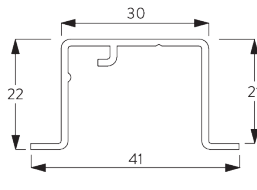

**SG 11230**

Recess profile



## B. HOW TO MEASURE

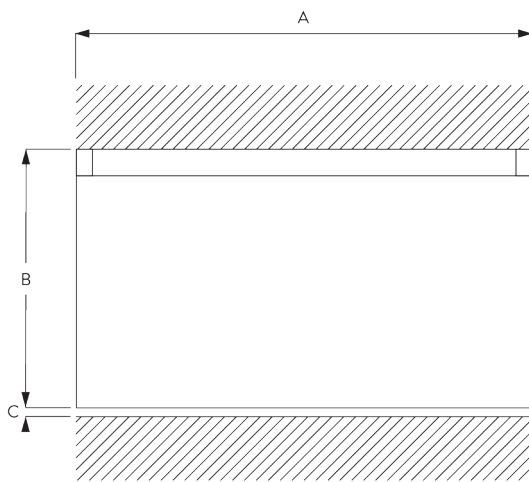

A: System width

B: System height

C: Distance between floor and fabric

## C. SPECIFICATION TEXT

### EN

Silent Gliss SG 6870 Hand Drawn Curtain Track System. Comprises aluminium profile SG 11190 supplied made to measure in silver anodised or white powder coated, alternatively a specified RAL colour. SG 11130 at 14/m, 2 end covers SG 11233 and 2 SG 6065 stops. Top fixed with brackets SG 3825/3826/3832 max. 500 mm centres. Wall fix SG Smart Fix at max. 500mm centres. Silent Gliss Wave option is available. Optional recess profile SG 11230.

### SV

Silent Gliss SG 6870 handdragssystem. Består av aluminiumprofil SG 11190 i specificerad längd i vitlack, alu natur eller angiven RAL färg. Kan användas med system Wave. 14 st SG 11300 SILENT TRACK glid per meter, 2 st SG 11233 ändskydd samt 2 st SG 6065 vridstopp per system. Takmonteras med fäste SG 3825/3826/3832 c/c 500 mm. Vägghmontering med SG Smart Fix c/c 500 mm. Kan kombineras med Wave. Kan levereras med infällningsprofil SG 11230.

### NO

Silent Gliss SG 6870 Manuell gardinskinne. Består av aluminiumprofil SG 11190 i spesifisert lengde, standard i hvitlakkert eller alu natur. Kan også leveres i spesifisert RAL farge. 14 stk SG 11300 SILENT TRACK glidere pr meter, 2 stk 11233 endelokk og 2 stk SG 6065 vristopp pr system. Takmonteres med feste SG 3825/3826/3832 c/c 500mm. Veggmontering med SG Smart Fix c/c 500 mm. Kan kombineres med Wave system. Kan leveres med profil for innfelling SG 11230.

### DA

Silent Gliss SG 6870 håndtrukket gardinskinnesystem. Består af en aluminiumprofil SG 11190 i ønsket længde, sølvanodiseret eller hvid pulverlakering, alternativt en specificeret RAL-farve. 14 stk. SG 11300 glidere pr. m og 2 stk. SG 11233 endelæg samt 2 stk. SG 6065 endestop. Loftmonteres med beslagene SG 3825/3826/3832 med højst 500 mm afstand. Vægmonteres med SG Smart Fix med en afstand på højst 500 mm. Kan bruges med Silent Gliss Wave. Kan leveres med indfældningsprofil SG 11230.

# FITTING

## A. FITTING INFORMATION

For detailed fitting information, visit the Silent Gliss website.

### Fixing points

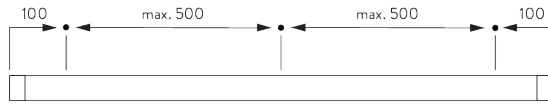

## B. CEILING FITTING

### Clamp SG 3825

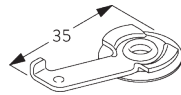
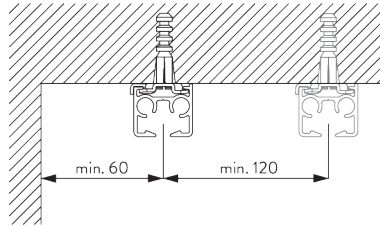

**SG 3825**  
Clamp

### Bracket SG 3826

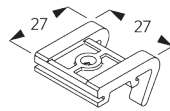
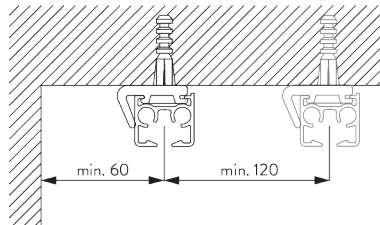

**SG 3826**  
Bracket

### Bracket SG 3832

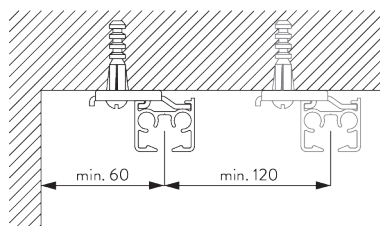

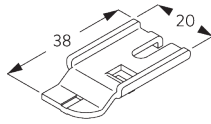

**SG 3832**

Bracket

## C. WALL FITTING

### Smart Fix

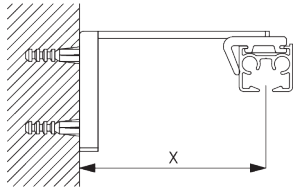

**Smart Fix SG 11200 - SG 11205 and bracket SG 3826:**

Screw SG 10492 (M4x8) needed.

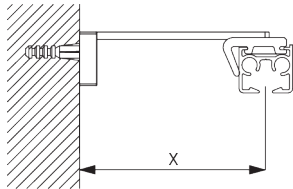

**Square Smart Fix SG 11210 - SG 11215 and bracket SG 3826:**

Screw SG 10492 (M4x8) needed.

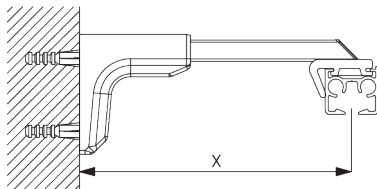

**Universal Smart Fix SG 11154 - SG 11156 and bracket SG 3826:**

Screw SG 10277 (M4x12) needed.

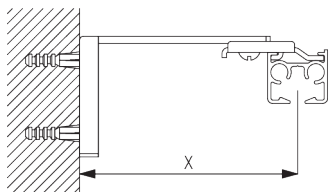

**Smart Fix SG 11200 - SG 11205 and bracket SG 3832:**

Screw SG 10492 (M4x8) needed.

Smart Fix	X mm (SG 3826 / SG 3825)	X mm (SG 3832)
SG 11200 / SG 11210	52	70
SG 11201 / SG 11211	72	90
SG 11202 / SG 11212	92	110
SG 11203 / SG 11213	112	130
SG 11204 / SG 11214	142	160
SG 11205 / SG 11215	192	210
SG 11154	102-130	120-148
SG 11155	132-160	150-178
SG 11156	182-210	200-228

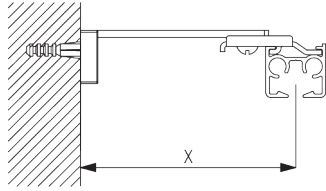

**Square Smart Fix SG 11210 - SG 11215 and bracket SG 3832:**

Screw SG 10492 (M4x8) needed.

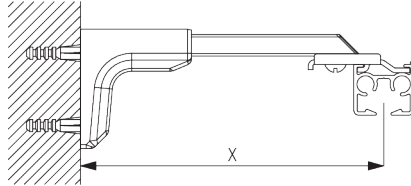

**Universal Smart Fix SG 11154 - SG 11156 and bracket SG 3832:**

Screw SG 10407 (M4x10) needed.

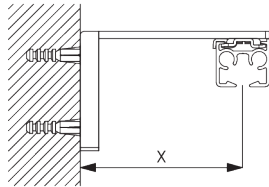

**Smart Fix SG 11200 - SG 11205 and clamp SG 3825:**

Screw SG 10074 (M4x8) needed.

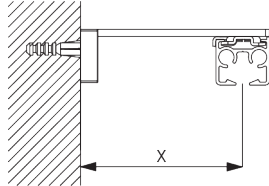

**Square Smart Fix SG 11210 - SG 11215 and clamp SG 3825:**

Screw SG 10074 (M4x8) needed.

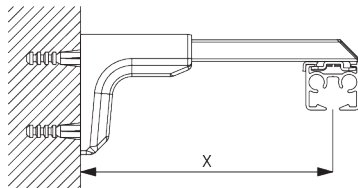

**Universal Smart Fix SG 11154 - SG 11156 and bracket SG 3825:**

Screw SG 11158 (M4x12) needed.

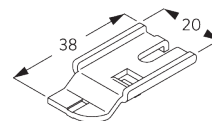
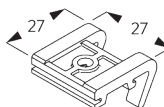
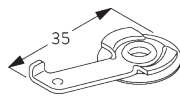

**SG 3825**  
Clamp

**SG 3826**  
Bracket

**SG 3832**  
Bracket

**SG 10074**  
Countersunk head screw  
M4x8



**SG 10277**  
Pan head screw M4x12



**SG 10407**  
Pan head screw M4x10



**SG 10492**  
Pan head screw M4x8



**SG 11158**  
Countersunk head screw  
M4x12

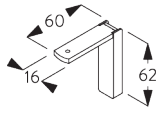

**SG 11200**  
Smart Fix 60 mm

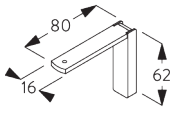

**SG 11201**  
Smart Fix 80 mm

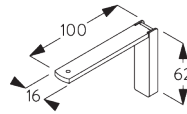

**SG 11202**  
Smart Fix 100 mm

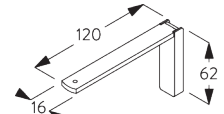

**SG 11203**  
Smart Fix 120 mm

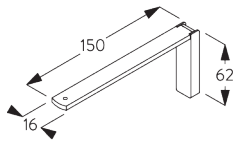

**SG 11204**  
Smart Fix 150 mm

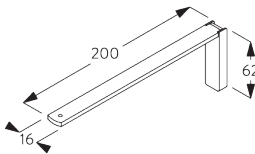

**SG 11205**  
Smart Fix 200 mm

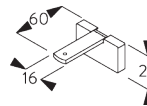

**SG 11210**  
Square Smart Fix 60 mm

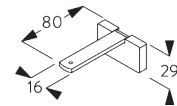

**SG 11211**  
Square Smart Fix 80 mm

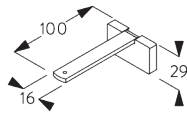

**SG 11212**  
Square Smart Fix 100 mm

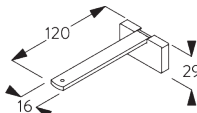

**SG 11213**  
Square Smart Fix 120 mm

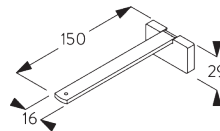

**SG 11214**  
Square Smart Fix 150 mm

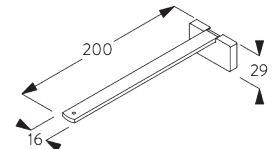

**SG 11215**  
Square Smart Fix 200 mm

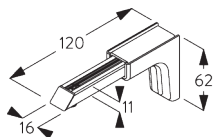

**SG 11154**  
Universal Smart Fix 120 mm

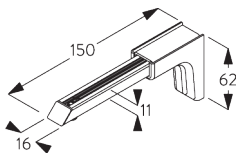

**SG 11155**  
Universal Smart Fix 150 mm

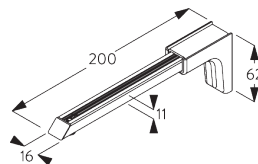

**SG 11156**  
Universal Smart Fix 200 mm

**Bracket SG 3836**

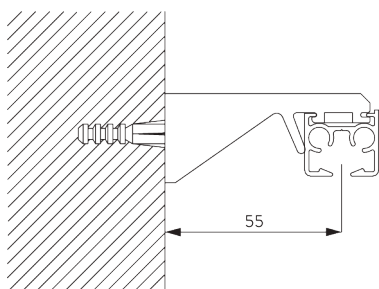

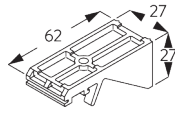

**SG 3836**  
Bracket

## D. RECESS FITTING

Recess profile  
SG 11230

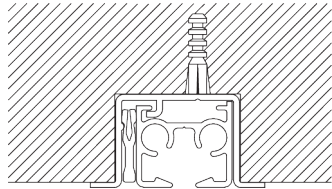

One wedge SG 10157 per fixing point.  
For detailed recess fitting, visit the Silent Gliss website.

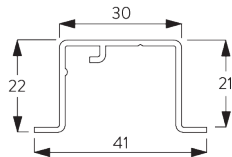

**SG 11230**  
Recess profile

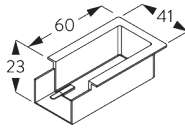

**SG 11238**  
Recess Mask

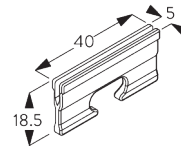

**SG 10157**  
Wedge

# SYSTEM OPTIONS

## A. WAVE

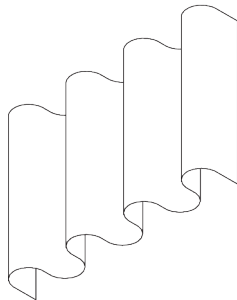

SG 11295

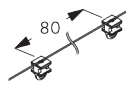

SG 11302

Standard components:

- SG 11295 End stop
- SG 11302 Wave 2C glider cord 80 mm

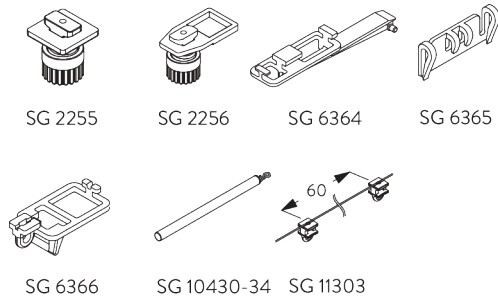

**Optional components:**

- SG 2255 Brake
- SG 2256 Brake
- SG 6364 Wave extension
- SG 6365 Wave hanger
- SG 6366 Wave carrier for draw rod
- SG 10430-34 Draw rod
- SG 11303 Wave 2C glider cord 60 mm

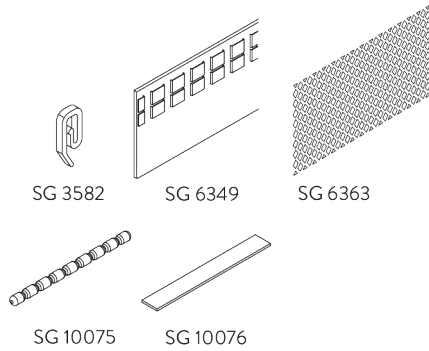

**Curtain components:**

- SG 3582 Hook
- SG 6349 Wave curtain tape
- SG 6363 Wave top hemming tape
- SG 10075 Lead weight 50 gr/m
- SG 10076 Fabric weight

**Wave stack depth - 2C glider cord (standard components)**

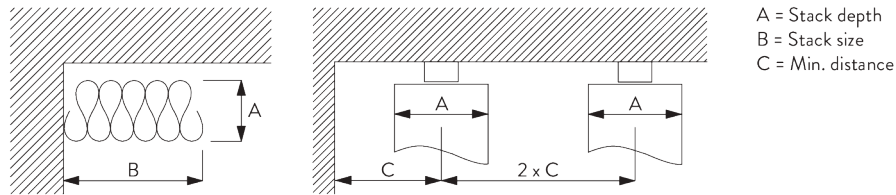

A = Stack depth  
 B = Stack size  
 C = Min. distance

2C Glider cord SG 11302	Pockets between hooks	Approx. curtain fullness	Stack depth A	Stack size B*	Min distance C
80	6	~2.1	140	180 per metre of track	90
80	7	~2.3	160	180 per metre of track	100







2C Glider cord SG 11303	Pockets between hooks	Approx. curtain fullness	Stack depth A	Stack size B*	Min distance C
60	4	~2.1	100	230 per metre of track	70
60	5	~2.3	120	230 per metre of track	80

\*Stack size B when using optional extension arm increases by 150 mm per curtain stack!



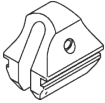







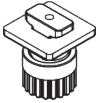

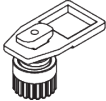

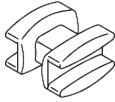





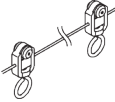
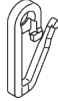



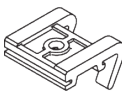

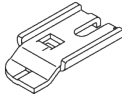
# PARTS

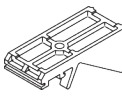
## A. STANDARD PARTS

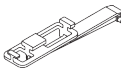
	<b>SG 3599</b> Hook
	<b>SG 3825</b> Clamp
	<b>SG 6065</b> End stop
	<b>SG 6086</b> Spring stop
	<b>SG 11190</b> Profile
	<b>SG 11233</b> End cover
	<b>SG 11300</b> 2C glider

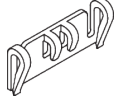
## B. OPTIONAL PARTS

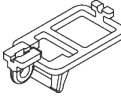
	<b>SG 2255</b> Brake		<b>SG 6057</b> Glider
	<b>SG 2256</b> Brake		<b>SG 6064</b> End stop
	<b>SG 3012</b> Hook		<b>SG 6082</b> Glider
	<b>SG 3555</b> Hook		<b>SG 6094</b> Roller
	<b>SG 3581</b> Hook		<b>SG 6098</b> Roller
	<b>SG 3582</b> Hook		<b>SG 6099</b> Wave roller cord 80 mm
	<b>SG 3598</b> Eyelet		<b>SG 6146</b> Hook
	<b>SG 3802</b> Connection bridge		<b>SG 6240</b> Roller
	<b>SG 3826</b> Bracket		<b>SG 6283</b> Roller
	<b>SG 3832</b> Bracket		<b>SG 6349</b> Wave curtain tape
	<b>SG 3836</b> Bracket		<b>SG 6363</b> Wave top hemming tape
	<b>SG 6004</b> Eyelet		<b>SG 6364</b> Wave extension
	<b>SG 6005</b> Hook		<b>SG 6365</b> Wave hanger
	<b>SG 6053</b> Spring stop		<b>SG 6366</b> Wave carrier for draw rod

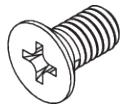
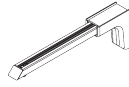
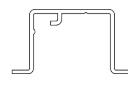
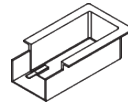
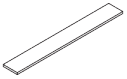
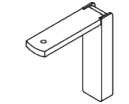
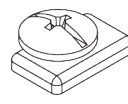
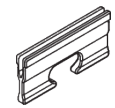
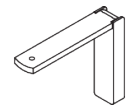
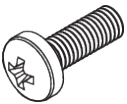
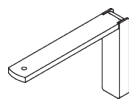
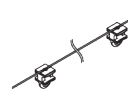
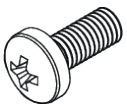
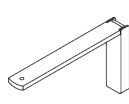
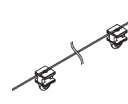
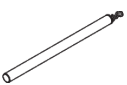
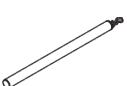
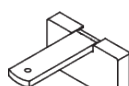
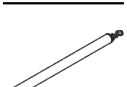
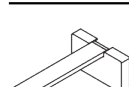
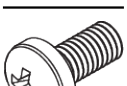
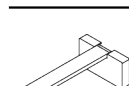
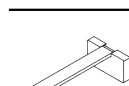
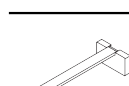
**SG 10074***Countersunk head screw M4x8***SG 11156***Universal Smart Fix 200 mm***SG 11230***Recess profile***SG 10075***Lead weight 50 g/m***SG 11158***Countersunk head screw M4x12***SG 11238***Recess Mask***SG 10076***Fabric weight***SG 11200***Smart Fix 60 mm***SG 11295***End stop***SG 10157***Wedge***SG 11201***Smart Fix 80 mm***SG 11301***2C glider on strip***SG 10277***Pan head screw M4x12***SG 11202***Smart Fix 100 mm***SG 11302***Wave 2C glider cord 80 mm***SG 10407***Pan head screw M4x10***SG 11203***Smart Fix 120 mm***SG 11303***Wave 2C glider cord 60 mm***SG 10430***Draw rod 50 cm***SG 11204***Smart Fix 150 mm***SG 11305***2C glider for direct sewing***SG 10431***Draw rod 75 cm***SG 11205***Smart Fix 200 mm***SG 10432***Draw rod 100 cm***SG 11210***Square Smart Fix 60 mm***SG 10433***Draw rod 125 cm***SG 11211***Square Smart Fix 80 mm***SG 10434***Draw rod 150 cm***SG 11212***Square Smart Fix 100 mm***SG 10492***Pan head screw M4x8***SG 11213***Square Smart Fix 120 mm***SG 11154***Universal Smart Fix 120 mm***SG 11214***Square Smart Fix 150 mm***SG 11155***Universal Smart Fix 150 mm***SG 11215***Square Smart Fix 200 mm*

# SG 6970

---

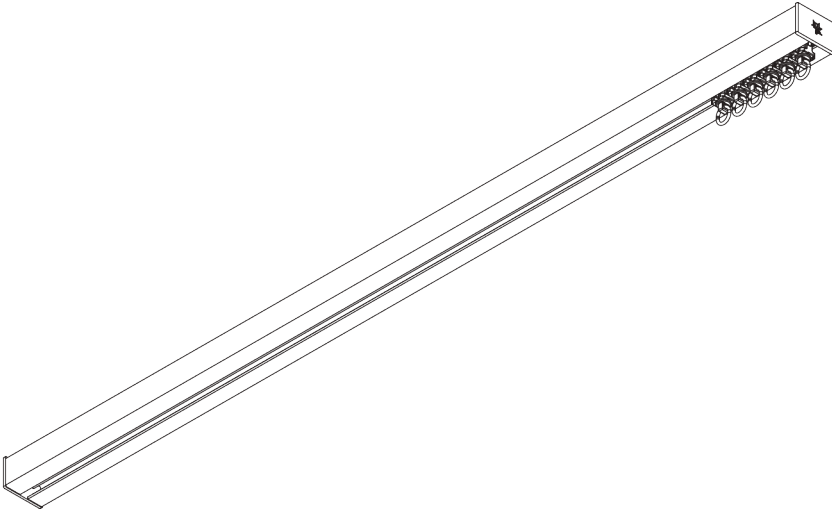
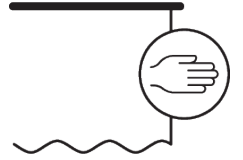

## PRODUCT INFORMATION

- **Operation:** hand
- **Range:** M - L
- **Fitting:** ceiling, wall, recess
- **Colours:** white RAL 9016, black RAL 9005 or anodised aluminum, special colours possible (recess profile only in white RAL 9016, black RAL 9005 or special color)
- **Fabrics:** refer to Silent Gliss fabric collection

### **Features:**

- 2-component (2C) roller technology
- Wave (2C)
- Bendable
- Bendable recess profile

# SYSTEM SPECIFICATIONS

## A. PROFILE

### Profile and bending information

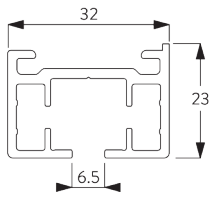

#### SG 10850

Profile

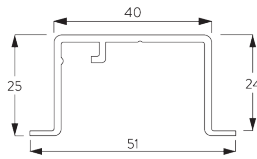

#### SG 10862

Recess profile



## B. HOW TO MEASURE

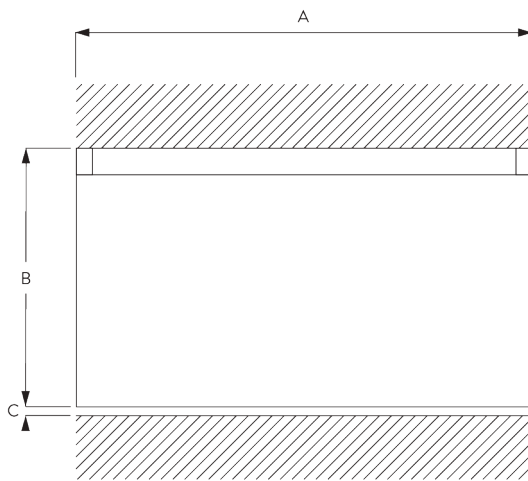

A: System width

B: System height

C: Distance between floor and fabric

## C. SPECIFICATION TEXT

### EN

Silent Gliss SG 6970 Hand Drawn Curtain Track System. Comprises aluminium profile SG 10850 supplied made to measure in silver anodised or white powder coated, alternatively a specified RAL colour. SG 10840 at 10/m, 2 end covers SG 11235. Top fixed with brackets SG 3004/3041 max. 500 mm centres. Wall fix SG Smart Fix at max. 500 mm centres. Optional recess profile SG 10862. Silent Gliss Wave option is available.

### SV

Silent Gliss SG 6970 handdragssystem. Består av aluminiumprofil SG 10850 i specificerad längd i vitlack, alu natur eller angiven RAL färg. 10 st SG 10840 glid per meter, 2 st SG 11235 ändskydd per system. Takmonteras med fäste SG 3004/3041 c/c 500 mm. Vägmontering med SG Smart Fix c/c 500 mm. Kan levereras med infällningsprofil SG 10862. Kan användas med system Wave.

### NO

Silent Gliss SG 6970 Manuell gardinskinne. Består av aluminiumprofil SG 10850 i spesifisert lengde, standard i hvitlakkert eller alu natur. Kan også leveres i spesifisert RAL farge. 10 stk SG 10840 glidere pr meter, 2 stk 11235 endelokk pr system. Takmonteres med feste SG 3004/3041 c/c 500 mm. Veggmontering med SG Smartfix c/c 500 mm. Kan leveres med profil for innfelling SG 10862. Kan kombineres med Wave system.

### DA

Silent Gliss SG 6970 håndtrukket gardinskinnesystem. Består af en aluminiumprofil SG 10850 i ønsket længde, sølvanodiseret eller hvid pulverlakering, alternativt en specificeret RAL-farve. 10 stk. SG 10840 pr. m og 2 stk. SG 11235 endelåg. Loftmonteres med beslagene SG 3004/3041 højst 500 mm afstand. Vægmonteres med SG Smart Fix med en afstand på højst 500 mm. Kan leveres med indfældningsprofil SG 10862. Kan bruges med Silent Gliss Wave.

# FITTING

## A. FITTING INFORMATION

For detailed fitting information, visit the Silent Gliss website.

### Fixing points

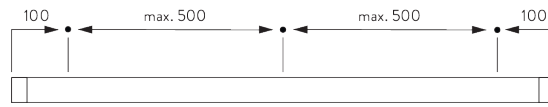

## B. CEILING FITTING

### Clamp SG 3004

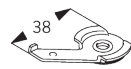
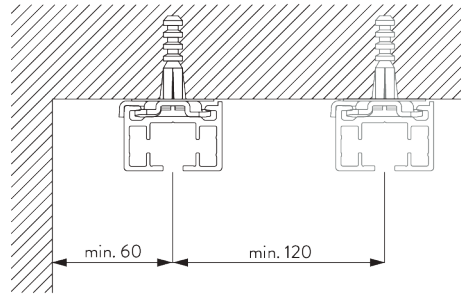

**SG 3004**

Clamp

### Direct fitting

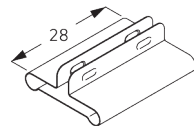
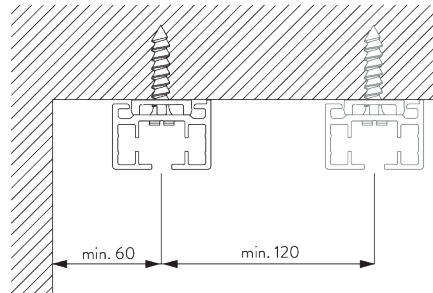

**SG 7002**

Profile protector

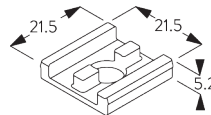

**SG 10865**

Support plate

## Bracket SG 3041

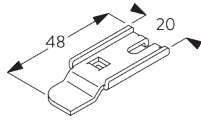
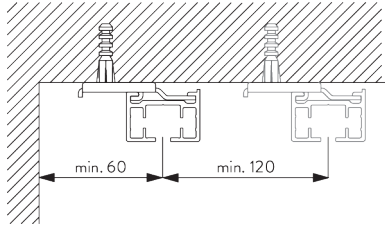

**SG 3041**

Bracket

## C. WALL FITTING

### Smart Fix

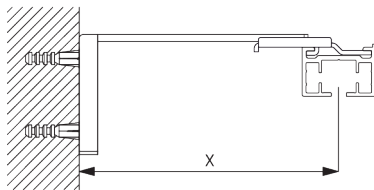

**Smart Fix SG 11200 - SG 11205 and bracket SG 3041:**  
Screw SG 10492 (M4x8) needed.

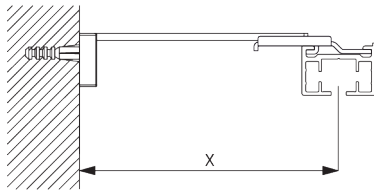

**Square Smart Fix SG 11210 - SG 11215 and bracket SG 3041:**  
Screw SG 10492 (M4x8) needed.

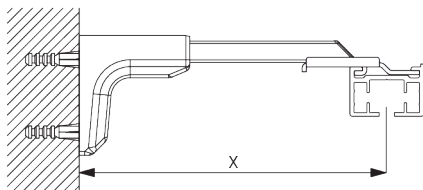

**Universal Smart Fix SG 11154 - SG 11156 and bracket SG 3041:**  
Screw SG 10407 (M4x10) needed.

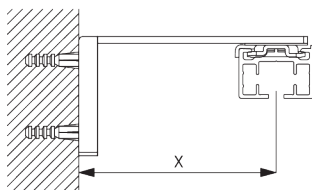

**Smart Fix SG 11201 - SG 11205 and clamp SG 3004:**  
Screw SG 10074 (M4x8) needed.

Smart Fix	X mm (SG 3041)	X mm (SG 3004)
SG 11200 / SG 11210	83	
SG 11201 / SG 11211	103	72
SG 11202 / SG 11212	123	92
SG 11203 / SG 11213	143	112
SG 11204 / SG 11214	173	142
SG 11205 / SG 11215	223	192
SG 11154	128-156	102-130
SG 11155	158-186	132-160
SG 11156	208-236	182-210

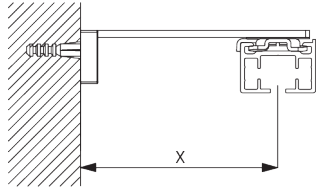

**Square Smart Fix SG 11211 - SG 11215 and clamp  
SG 3004:**

Screw SG 10074 (M4x8) needed.

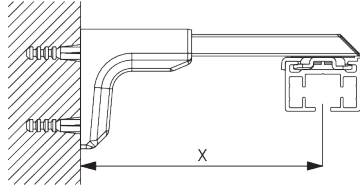

**Universal Smart Fix SG 11154 - SG 11156 and clamp  
SG 3004:**

Screw SG 11158 (M4x12) needed.

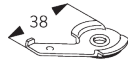

**SG 3004**  
Clamp

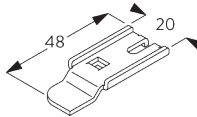

**SG 3041**  
Bracket



**SG 10074**  
Countersunk head screw  
M4x8



**SG 10407**  
Pan head screw M4x10



**SG 10492**  
Pan head screw M4x8



**SG 11158**  
Countersunk head screw  
M4x12

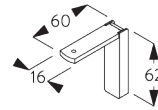

**SG 11200**  
Smart Fix 60 mm

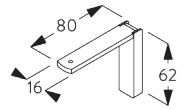

**SG 11201**  
Smart Fix 80 mm

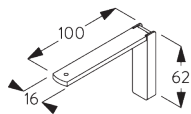

**SG 11202**  
Smart Fix 100 mm

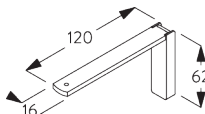

**SG 11203**  
Smart Fix 120 mm

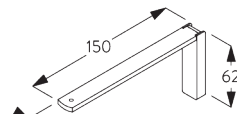

**SG 11204**  
Smart Fix 150 mm

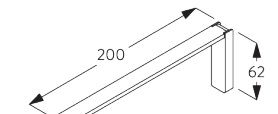

**SG 11205**  
Smart Fix 200 mm

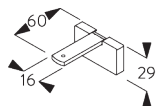

**SG 11210**  
Square Smart Fix 60 mm

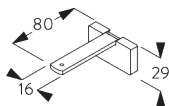

**SG 11211**  
Square Smart Fix 80 mm

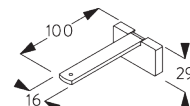

**SG 11212**  
Square Smart Fix 100 mm

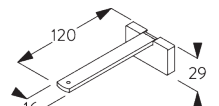

**SG 11213**  
Square Smart Fix 120 mm

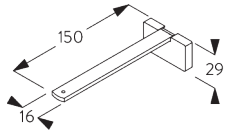

**SG 11214**  
Square Smart Fix 150 mm

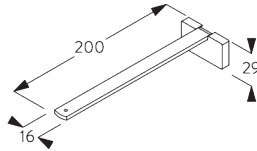

**SG 11215**  
Square Smart Fix 200 mm

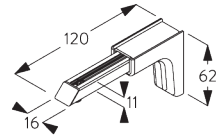

**SG 11154**  
Universal Smart Fix 120 mm

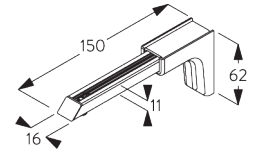

**SG 11155**  
Universal Smart Fix 150 mm

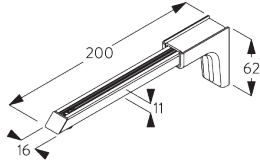

**SG 11156**  
Universal Smart Fix 200 mm

## D. RECESS FITTING

### Recess profile SG 10862

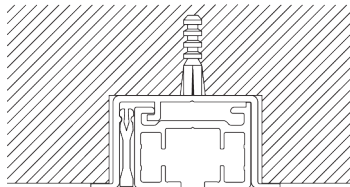

One wedge SG 5118 per fixing point.  
For detailed recess fitting, visit the Silent Gliss website.

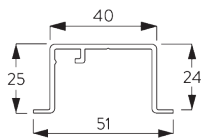

**SG 10862**  
Recess profile

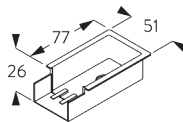

**SG 10864**  
Recess mask

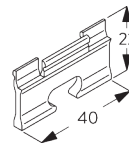

**SG 5118**  
Wedge

## E. SUSPENDED FITTING

### Hanger SG 6105

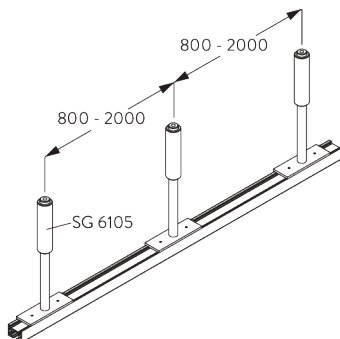



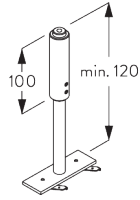

**SG 6105**  
Hanger with plate

**V-hanger SG 6107**

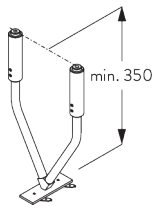
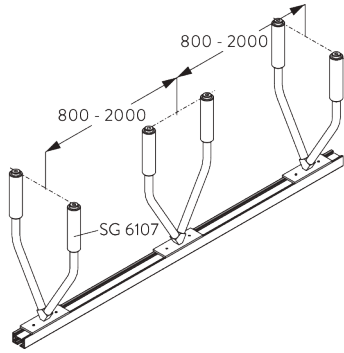

**SG 6107**  
V-Hanger with plate

# SYSTEM OPTIONS

**A. WAVE**

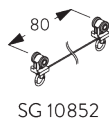
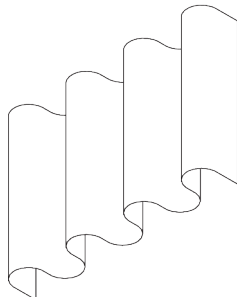

- Standard components:
- SG 11295 End stop
  - SG 10852 Wave 2C roller cord 80 mm

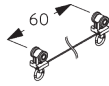

SG 10869

Optional components:

- SG 10869 Wave 2C roller cord 60 mm

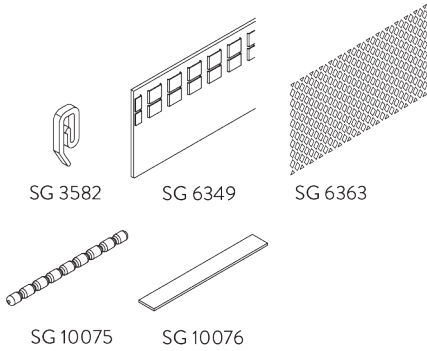

Curtain components:

- SG 3582 Hook
- SG 6349 Wave curtain tape
- SG 6363 Wave top hemming tape
- SG 10075 Lead weight 50 gr/m
- SG 10076 Fabric weight

Wave stack depth - 2C roller cord (standard components)

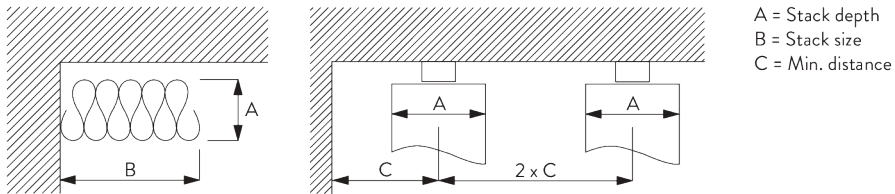



A = Stack depth  
B = Stack size  
C = Min. distance

2C Roller cord SG 10852	Pockets between hooks	Approx. curtain fullness	Stack depth A	Stack size B	Min distance C
80	6	~2.1	140	210 per metre of track	90
80	7	~2.3	160	210 per metre of track	100





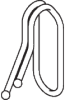

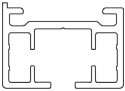
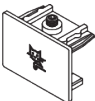
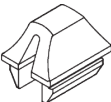

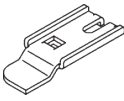
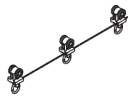

2C Roller cord SG 10869	Pockets between hooks	Approx. curtain fullness	Stack depth A	Stack size B	Min distance C
60	4	~2.1	100	260 per metre of track	70
60	5	~2.3	120	260 per metre of track	80

# PARTS

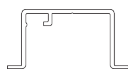
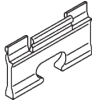
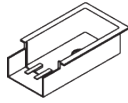
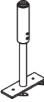
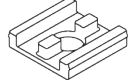
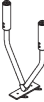
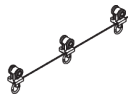
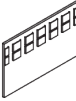
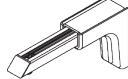
## A. STANDARD PARTS

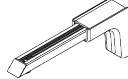
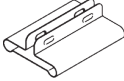
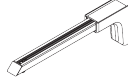
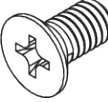
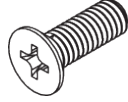
	<b>SG 3004</b> Clamp
	<b>SG 3581</b> Hook
	<b>SG 10840</b> 2C roller
	<b>SG 10850</b> Profile
	<b>SG 11235</b> End cover
	<b>SG 11465</b> Spring stop

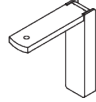
## B. OPTIONAL PARTS

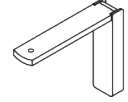
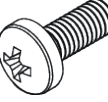
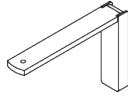
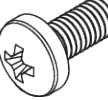
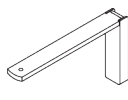
	<b>SG 3012</b> Hook		<b>SG 10831</b> Connection bridge
	<b>SG 3041</b> Bracket		<b>SG 10852</b> Wave 2C roller cord 80 mm
	<b>SG 3582</b> Hook		<b>SG 10862</b> Recess profile
	<b>SG 5118</b> Wedge		<b>SG 10864</b> Recess mask
	<b>SG 6105</b> Hanger with plate		<b>SG 10865</b> Support plate
	<b>SG 6107</b> V-Hanger with plate		<b>SG 10869</b> Wave 2C roller cord 60 mm
	<b>SG 6349</b> Wave curtain tape		<b>SG 11154</b> Universal Smart Fix 120 mm
	<b>SG 6363</b> Wave top hemming tape		<b>SG 11155</b> Universal Smart Fix 150 mm
	<b>SG 7002</b> Profile protector		<b>SG 11156</b> Universal Smart Fix 200 mm
	<b>SG 10074</b> Countersunk head screw M4x8		<b>SG 11158</b> Countersunk head screw M4x12
	<b>SG 10075</b> Lead weight 50 g/m		<b>SG 11200</b> Smart Fix 60 mm
	<b>SG 10076</b> Fabric weight		<b>SG 11201</b> Smart Fix 80 mm
	<b>SG 10407</b> Pan head screw M4x10		<b>SG 11202</b> Smart Fix 100 mm
	<b>SG 10492</b> Pan head screw M4x8		<b>SG 11203</b> Smart Fix 120 mm

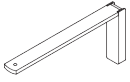

**SG 11204**

Smart Fix 150 mm



**SG 11205**

Smart Fix 200 mm

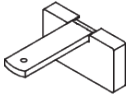

**SG 11210**

Square Smart Fix 60 mm

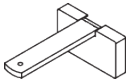

**SG 11211**

Square Smart Fix 80 mm

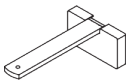

**SG 11212**

Square Smart Fix 100 mm

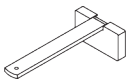

**SG 11213**

Square Smart Fix 120 mm

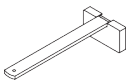

**SG 11214**

Square Smart Fix 150 mm

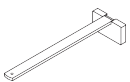

**SG 11215**

Square Smart Fix 200 mm

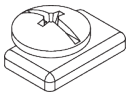

**SG 11295**

End stop







## *The Architects of Silence*

***Silent Gliss is the leading global supplier of premium interior window treatments. Since 1952 we have been tirelessly committed to the development of the worlds` smoothest, quietest systems using state of the art technology.***

*Driven by customer needs, Silent Gliss offers functional and durable products. Expert technical advice coupled with installation and support services complete the offer. Silent Gliss stands for innovative, sustainable, tailor made solutions, exceptional design and first-class quality.*

### **Silent Gliss Nordic AB**

Travbanegatan 9  
213 77 Malmö  
Sweden  
**T** +46 40 55 52 50  
info@silentgliss.se

Byggdøy Allé 111A  
0273 Oslo  
Norway  
**T** +47 24 11 80 60  
info@silentgliss.no

Denmark  
**T** +45 36 77 67 00  
info@silentgliss.dk

**silentgliss.se**  
**silentgliss.no**  
**silentgliss.dk**