

SG 7600

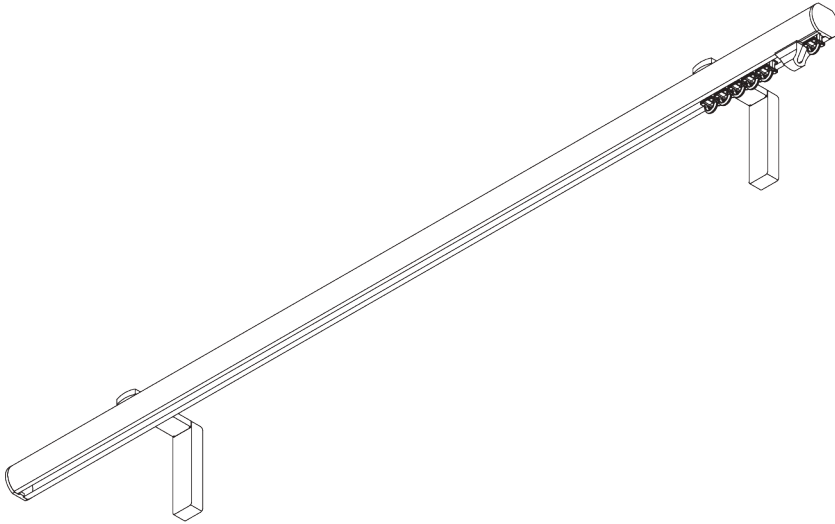
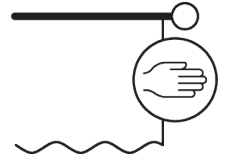

PRODUCT INFORMATION

- **Operation:** hand
- **Range:** S
- **Fitting:** ceiling, wall
- **Colours:** white RAL 9016, various colours / finishes
- **Fabrics:** refer to Silent Gliss fabric collection

Features:

- 2-component (2C) glider technology
- Wave (2C)
- Matching endcaps and brackets / bracket covers
- Range of decorative finials
- Bendable

SYSTEM SPECIFICATIONS

A. PROFILE

Profile and bending information

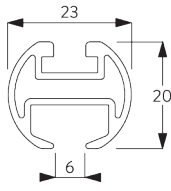

SG 11606

Profile

Radius:
✓ 15 cm, 20 cm, >25 cm

B. HOW TO MEASURE

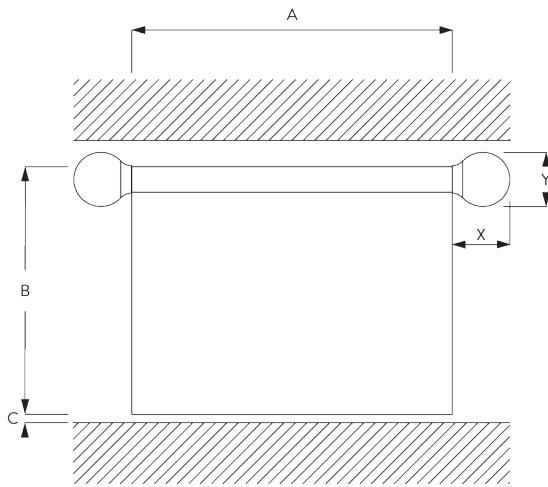

A: System width without finials







B: System height

C: Distance between floor and fabric

X: Finial width

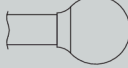
Y: Finial height

Finial Measurements

		23 mm	
		X	Y
	SG 11602	2	23
	SG 11621	8	27
	SG 11622	14	38
	SG 11726	49	46
	SG 11727	89	37
	SG 11728	20	69
	SG 11729	18	46

C. SPECIFICATION

TEXT

SV

Silent Gliss SG 7600 'Metropole' handdragssystem består av 23mm rund aluminiumprofil SG 11606 i specificerad längd. 14 st 2C glid SG 11300 per meter, 2st vridstopp 6065, ändskydd SG 11602. Raka profiler levereras som standard med väggvinkel "Smart Fix" SG 11206. Alternativ väggvinkel Smart Fix SG11207-11208/ Smart Fix Square SG 11216-11218 eller Fillet SG 11669. Takbeslag SG 11668 eller minihängare SG 6175, samtliga beslag monteras c/c 600mm. Profiler och beslag lackeras i Vit, Matt vit, Silver, Taupe, Antique bronze, Svart, Charcoal och Bronze. Flertalet dekorativa ändknoppar finns i olika former och färger. Wave finns som alternativ. Wave 2C glid 60 mm SG 11303 / 80 mm SG 11302. Levereras som standard med stoppskriv SG 11295.

NO

Silent Gliss SG 7600 Metropole håndført gardinskinnesystem. Består av 23 mm rund aluminiumsprofil SG 11606 i spesifiserte lengder med 14 stk 2C glidere SG 11300 pr. meter, 2 stk SG 6065 vristopper og 2 stk Flush endeløkk SG 11602. Rette system leveres som standard med 60 mm veggvinkel Smart Fix SG 11206 hver 600 mm. Alternative veggvinkler Smart Fix SG 11207-11208 / Square Smart Fix SG 11216-11218 eller Fillet brakett SG 11669. Alternative takfester er Top Fix SG 11668 eller Mini-henger SG 6175, alle fester monteres c/c 600 mm. Farger: White, Matt White, Silver, Taupe, Antique Bronze, Bronze, Charcoal og Black. Endedekor: Flush, Stud, Design, Ball end, Taper, Ellipse og Spear. Alternativ med Wave 80 mm 2C glider SG 11302 eller 60 mm SG 11303. Leveres som standard med stoppskrue SG 11295.

DA

Silent Gliss SG 7600 Metropole håndtrukket gardinskinnesystem. Består af en 23 mm rund aluminiumsprofil SG 11606 i ønsket længde med 14 stk 2C glidere SG 11300 pr. meter, 2 stk SG 6065 endestop og 2 stk Flush endelåg SG 11602. Leveres som standard med 60 mm vægvinkel Smart Fix SG 11206 for hver 600 mm. Alternative vægvinkler Smart Fix SG 11207-11208 / Square Smart Fix SG 11216-11218 eller Fillet vinkel SG 11669. Alternative loftbeslag er Top Fix SG 11668 eller Mini hanger SG 6175, alle beslag monteres c/c 600 mm. Farver: White, Matt White, Silver, Taupe, Antique Bronze, Bronze, Charcoal og Black. Endedekor: Flush, Stud, Design, Ball end, Taper, Ellipse og Spear. Alternativ med Wave 80 mm 2C glider SG 11302 eller 60 mm SG 11303. Leveres som standard med stoppskrue SG 11295.

FITTING

A. FITTING INFORMATION

For detailed fitting information, visit the *Silent Gliss* website.

Fixing points

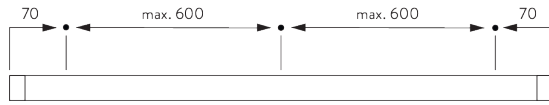

B. CEILING FITTING

Top fix bracket SG 11668

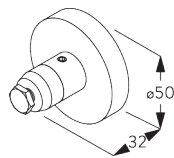
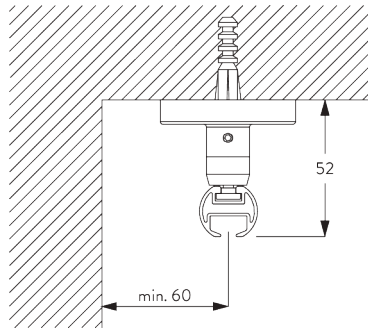

SG 11668

Top fix bracket

Mini hanger SG 6175

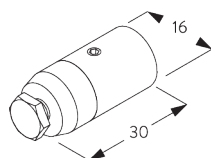
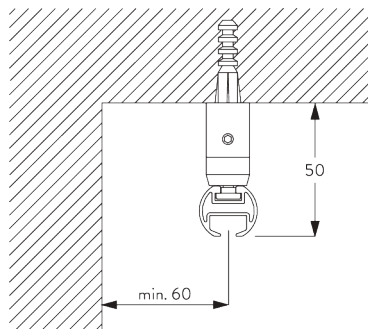

SG 6175

Mini hanger

C. WALL FITTING

Smart Fix

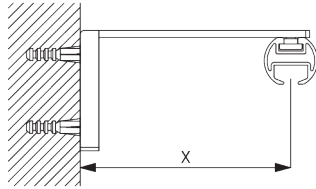

Smart Fix with slot SG 11206 - SG 11208 and SG 6141:
Screw SG 10492 (M4x8) needed.

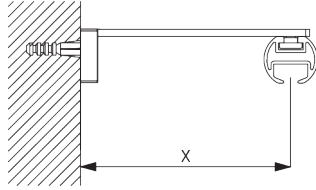

Square Smart Fix with slot SG 11216 - SG 11218 and SG 6141:
Screw SG 10492 (M4x8) needed.

Smart Fix	X mm
SG 11206 / SG 11216	51
SG 11207 / SG 11217	71
SG 11208 / SG 11218	91

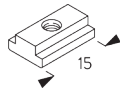

SG 6141
Clamping piece



SG 10492
Pan head screw M4x8

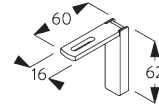

SG 11206
Smart Fix with slot 60 mm

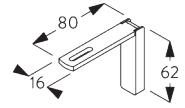

SG 11207
Smart Fix with slot 80 mm

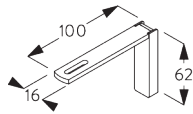

SG 11208
Smart Fix with slot 100 mm

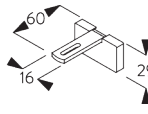

SG 11216
Square Smart Fix with slot 60 mm

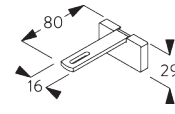

SG 11217
Square Smart Fix with slot 80 mm

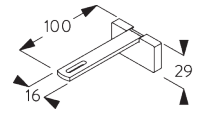

SG 11218
Square Smart Fix with slot 100 mm

Fillet Bracket SG 11669

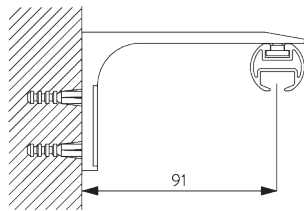

Screw SG 10492 (M4x8) needed.
Recommended for straight systems only.

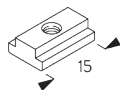

SG 6141
Clamping piece



SG 10492
Pan head screw M4x8

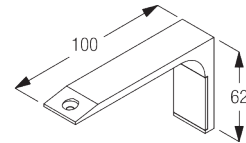

SG 11669
Fillet bracket

DESIGN & SYSTEM OPTIONS

A. ENDCAPS



Endcaps:

- SG 11602 Flush endcap 23 mm
- SG 11621 Stud endcap 23 mm
- SG 11622 Design endcap 23 mm

Please note:

- Without finials, poles are supplied as standard with flush fitting endcaps SG 11602 (left).
- Alternatively, stud endcaps SG 11621 can be selected at no additional cost.

B. FINIALS

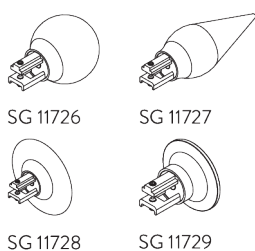

Finials are decorative elements that fit on at the end of the pole:

- SG 11726 Ball end 23 mm
- SG 11727 Spear 23 mm
- SG 11728 Ellipse 23 mm
- SG 11729 Taper 23 mm

C. WAVE

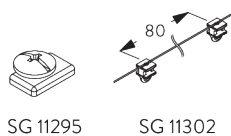
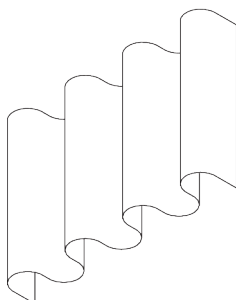

Standard components:

- SG 11295 End stop
- SG 11302 Wave 2C glider cord 80 mm

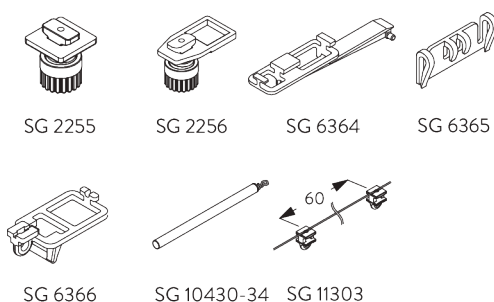

Optional components (min. Radius >25 cm):

- SG 2255 Brake
- SG 2256 Brake
- SG 6364 Wave extension
- SG 6365 Wave hanger
- SG 6366 Wave carrier for draw rod
- SG 10430-34 Draw rod
- SG 11303 Wave 2C glider cord 60 mm

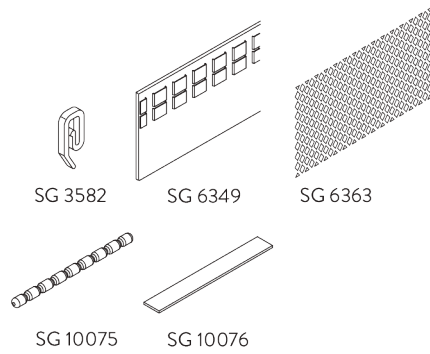

Curtain components:

- SG 3582 Hook
- SG 6349 Wave curtain tape
- SG 6363 Wave top hemming tape
- SG 10075 Lead weight 50 gr/m
- SG 10076 Fabric weigh

Wave stack depth - 2C glider cord (standard components)

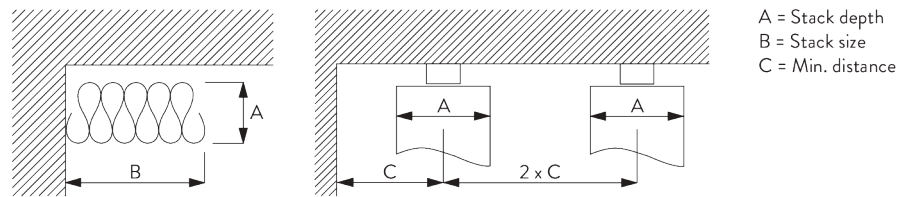

2C Glider cord SG 11302	Pockets between hooks	Approx. curtain fullness	Stack depth A	Stack size B*	Min distance C
80	6	~2.1	140	180 per metre of track	90
80	7	~2.3	160	180 per metre of track	100

2C Glider cord SG 11303	Pockets between hooks	Approx. curtain fullness	Stack depth A	Stack size B*	Min distance C
60	4	~2.1	100	230 per metre of track	70
60	5	~2.3	120	230 per metre of track	80

*Stack size B when using optional extension arm SG 6364 increases by 95 mm per curtain stack!

PARTS

A. STANDARD PARTS



SG 6065

End stop

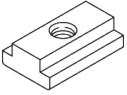

SG 6141

Clamping piece

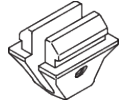

SG 6245

Spring stop

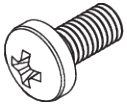

SG 10492

Pan head screw M4x8

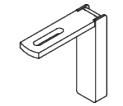

SG 11206

Smart Fix with slot 60 mm

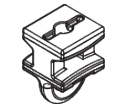

SG 11300

2C glider

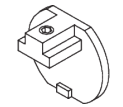

SG 11602

Flush end cap 23 mm



SG 11606

Profile

B. OPTIONAL PARTS

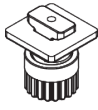

SG 2255

Brake



SG 2256

Brake

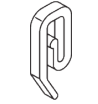

SG 3582

Hook



SG 3599

Hook

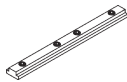

SG 6173

Connection bridge

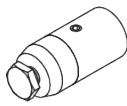

SG 6175

Mini hanger

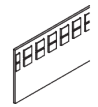

SG 6349

Wave curtain tape

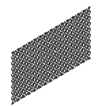

SG 6363

Wave top hemming tape

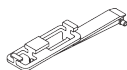

SG 6364

Wave extension

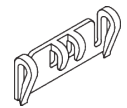

SG 6365

Wave hanger

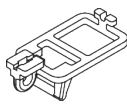

SG 6366

Wave carrier for draw rod

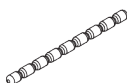

SG 10075

Lead weight 50 g/m



SG 10076

Fabric weight

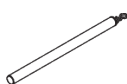

SG 10430

Draw rod 50 cm

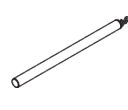

SG 10431

Draw rod 75 cm

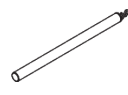

SG 10432

Draw rod 100 cm

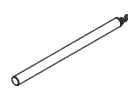

SG 10433

Draw rod 125 cm

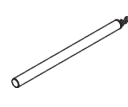

SG 10434

Draw rod 150 cm

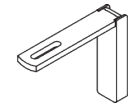

SG 11207

Smart Fix with slot 80 mm

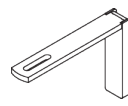

SG 11208

Smart Fix with slot 100 mm

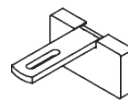

SG 11216

Square Smart Fix with slot 60 mm

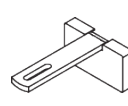

SG 11217

Square Smart Fix with slot 80 mm

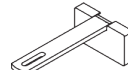

SG 11218

Square Smart Fix with slot 100 mm

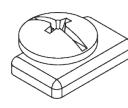

SG 11295

End stop



SG 11301

2C glider on strip



SG 11302

Wave 2C glider cord 80 mm



SG 11303

Wave 2C glider cord 60 mm



SG 11621

Stud end cap 23 mm

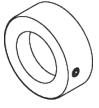

SG 11622

Design end cap 23 mm



SG 11668

Top fix bracket

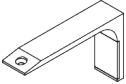

SG 11669

Fillet bracket

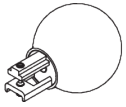

SG 11726

Ball end 23 mm

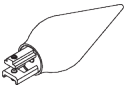

SG 11727

Spear 23 mm

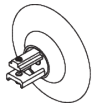

SG 11728

Ellipse 23 mm

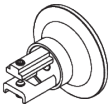

SG 11729

Taper 23 mm
